



**E-TENDER**

**FOR**

**Name of Work: - (HE-C-CT-CCRD-06) Laying/Replacement of various dia. water mains and allied works due to proposed improvement of roads in cement concrete in C & D wards in Zone-I City (2024-2026).**

**Tender Reference no.: - HE/1734 / SR dated 11.09.2024**

**Work Code: - HE-C-CT-CCRD-06**

**Tender ID: - 2024\_MCGM\_1084321**

Sd/-  
S.E.W.W.(Const.) City

Sd/-  
A.E.W.W.(Const.) City

Sd/-  
E.E.W.W.(Const.) City

Sd/-  
Dy. Hydraulic Engineer  
(Construction)

Sd/-  
Hydraulic Engineer

**Website:** <http://mahatenders.gov.in/>

Office of the Executive Engineer Water Works (Construction)City

Hydraulic Engineer's Department,

B. M. C. Engineering Hub Building, First Floor,

Dr. E Moses Road, Worli,

Mumbai – 400018

**This page is intentionally kept Blank**

## INDEX

SECTION	DESCRIPTION	PG. NO.
1	E-TENDER NOTICE	05 to 12
2	ELIGIBILITY(POST-QUALIFICATION) CRITERIA	13 to 18
3	DISCLAIMER	19 to 22
4	INTRODUCTION	23 to 26
5	E-TENDER ONLINE SUBMISSION PROCESS	27 to 30
6	INSTRUCTIONS TO APPLICANTS	31 to 106
7	SCOPE OF WORK	105 to 116
8	BILL OF QUANTITIES	117 to 158
9	GENERAL CONDITIONS OF CONTRACT	159 to 207
10	SPECIFICATIONS	209 to 211
11	FRAUD AND CORRUPT PRACTICES	213 to 218
12	PRE-BID MEETING	219 to 221
13	LIST OF APPROVED BANKS	223 to 230
14	APPENDIX	231 to 299

**This page is intentionally kept Blank**

# **SECTION 1**

# **E-TENDER NOTICE**

**This page is intentionally kept Blank**

**BRIHANMUMBAI MUNICIPAL CORPORATION**

Dy.H.E./Const/City- 8/Tender/2024-25 dated 12.09.2024

**E-TENDER NOTICE**

**Subject: - (HE-C-CT-CCRD-06) Laying/Replacement of various dia. water mains due to proposed improvement of roads in cement concrete in C ward & D ward of city section (2024-2026).**

The Brihanmumbai Municipal Corporation (BMC) invites online e-tender to appoint Contractor for the aforementioned work from contractors of repute, multidisciplinary engineering organizations i.e. eminent firm, Proprietary/Partnership Firms/ Private Limited Companies/ Public Limited Companies/Companies registered under the Indian companies act 2013, the contractors registered with the Brihanmumbai Municipal Corporation (BMC) in **Class AA, Category IV as per old registration and Class I (A) as per new registration** and from the contractors/firms equivalent and superior classes registered in Central or State Government/Semi Govt. Organization/Central or State Public Sector Undertakings, will be allowed subject to condition that, the contractors who are not registered with BMC will have to apply for registering their firm within three months' time period from the award of contract, and shall establish office in Mumbai Metropolitan Region otherwise their Bid Security i.e. **E.M.D (Earnest Money Deposit) will be forfeited/recovered and an amount equal to Registration Fee of respective class will be recovered as penalty.** Bidding Process will comprise of THREE stages.

The forms of Tender documents are available on the e-Tendering website <https://mahatenders.gov.in>. The aspiring Applicants will have to download Tender form, from the website mentioned above. The bidder has to fill in online format and upload information regarding Tender Online. Also, he has to download the Tender application form from website, fill it and upload the scanned copy of duly filled form, along with required documents.

For purchasing the Tender documents, the bidders will have to get registered with e-tender portal (<https://mahatenders.gov.in>) for the e-tendering process and obtain login credentials to participate in the online Tender process. The details of the same are available on <https://mahatenders.gov.in>. For registration, enrolment for digital signature certificates and user manual, please refer to respective links provided in e-tendering tab on <https://mahatenders.gov.in>.

The applicant has to pay Scrutiny Fee of Rs. 27,500 + 18 % GST (9 % CGST+ 9 % SGST)) in any CFC of BMC by challan (as per Circular No. CA/FRG/03/dt. 11.05.2023 & CA/FRG/10/dt. 19.10.2023 & CA/FRG/18/dt. 27.02.2024) after opening of Packet A & B and before opening of Packet C.

Name and location of work	Contract Period	Estimated Cost of Project
<b>(HE-C-CT-CCRD-06) Laying/Replacement of various dia. water mains due to proposed improvement of roads in cement concrete in C ward &amp; D ward of city section (2024-2026).</b>	<b>24 Months (Excluding Monsoon)</b>	<b>Rs. 33,55,41,977/- (Excluding GST)</b>

While submitting duly filled tender document through e-tender portal <https://mahatenders.gov.in> bidder needs to pay Earnest Money Deposit (EMD) (1% of Estimated Cost) amounting to **Rs. 33,55,500/- (Rupees Thirty Three Lakhs Fifty Five Thousand and Five Hundred Only)** through online payment gateway of GoM on url <https://mahatenders.gov.in>. EMD is refundable in accordance to the relevant clause of bid document, except in the case of the selected Bidder whose Bid Security/EMD shall be retained. The Bidders will have to provide Earnest Money Deposit through the payment gateways as mentioned above while submitting the bids. The Bid shall be summarily rejected if it is not accompanied by the Earnest Money Deposit. The tender is available one-Tendering website <https://mahatenders.gov.in> as mentioned in the Header Data of the tender.

- The Applicant has to prepare & submit Tender Documents Online on or before last date of submission as mentioned in tender notice.
- The Applicant should upload the documents in readable form, He should take trial of uploads by taking printout. The unreadable documents will be treated as null & void. The remaining documents will be evaluated. The decision of opening Authority regarding this will be binding to all applicants.
- The Municipal Commissioner reserves the right to reject all or any of the e- tender(s) without assigning any reasons at any stage.
- This tender document is not transferable.

Packet A, B& C shall be opened on dates as mentioned in header data. All the responsive and eligible bidders if they so wish can be present at the time of opening of bids, in the office of Executive Engineer, Water Works (Construction) City. The Packet C shall be opened if bids submission in Packet A & B satisfies/includes all the requirements and same are found acceptable to the Authority.



The dates and time for submission and opening the bids are as shown in the Header Data. If there are any changes in the dates the same will be displayed on the BMC Portal ( <http://portal.mcgm.gov.in>) as well as <https://mahatenders.gov.in>.

The Applicants interested in the above referred works may contact the Executive Engineer Water Works (Const.) City at the following address on any working day during office hours.

Office of the Executive Engineer Water Works (Construction)City  
Hydraulic Engineer's Department,  
B. M. C. Engineering Hub Building, First Floor,  
Dr. E Moses Road, Worli,  
Mumbai – 400018

The applicants if desired may visit the area under reference i.e. **C & D wards of Zone I in City Division** area of Mumbai and can collect the information of the present status from the Office of **Executive Engineer Water Works (Const.)City** who have invited the bids.

The BMC reserves the rights to accept any of the application or reject any or all the application received for above works, without assigning any reasons thereof. The information regarding above subject matter is available e-Tendering website (<https://mahatenders.gov.in>).

Tenderers are requested to submit and upload the tenders in time on or before the stipulated day so as to avoid rush at the closing hours. BMC will not be responsible for poor connectivity of network / internet services / connectivity of servers / snag in system / breakdown of network / or any other interruptions. If any online information is uploaded but not received by Bid creator (BMC) within stipulated time limit, BMC will not be held responsible at any cost and such bids cannot be validated. Any online intimation / information asked to be submitted by Bidders /Contractors or sent to bidders/ Contractors, if not receiving or bounced back at the receiving end due to any problem in the server or connectivity, BMC will not be held responsible.

Sd/-

**Hydraulic Engineer**

**This page is intentionally kept Blank**

**HEADER DATA**

Tender Reference No:	Ref No:- <b>Dy.H.E./Const/City-8/Tender/2024-25</b> <b>dated 12.09.2024</b> Tender ID: - <b>2024_MCGM_1084321</b> Work code: <b>HE-C-CT-CCRD-06</b>
Name of Organization	Brihanmumbai Municipal Corporation
Subject	<b>(HE-C-CT-CCRD-06) Laying/Replacement of various dia. water mains due to proposed improvement of roads in cement concrete in C ward &amp; D ward of city section (2024-2026).</b>
Scrutiny Fees	Rs.27,500 + 18% GST (As per Circular No. CA/FRG/18/dt. 27.02.2024)
Cost of E-Tender(Estimated Cost)	<b>Rs. 33,55,41,977/-</b>
Bid Security Deposit/ EMD	<b>Total EMD: Rs. 33,55,500/-</b> (1% of Estimated cost)
Bid Validity Period	180 days (From Due date of Bid)
Bid Sale Start Date & Time	<b>19.08.2024</b> from 11.00 Hrs.
Bid Sale End Date & Time	<b>09.09.2024</b> upto 16.00 Hrs
Bid Submission End Date & Time	<b>09.09.2024</b> upto 16.00 Hrs
Pre-Bid Meeting	<b>26.08.2024</b> at 15:00 Hrs in conference room of Hydraulic Engineer, Municipal Engineering Hub Building, First Floor, Dr. E. Moses Road, Worli, Mumbai-400018
Opening of Packet A (Online)	<b>13.09.2024</b> after 12.00 Hrs.
Opening of Packet B (Online)	<b>20.09.2024</b> after 12.00 Hrs.
Opening of Packet C (Online)	<b>27.09.2024</b> after 12.00 Hrs.
Address for communication	Office of the Executive Engineer Water Works (Const.) City, Hydraulic Engineer's Department, B.M.C. Engineering Hub Building, First Floor, Dr. E Moses Road, Worli, Mumbai - 400018. Email: <a href="mailto:eeconstcity.he@mcm.gov.in">eeconstcity.he@mcm.gov.in</a>
Venue for opening of bid	Office of the Executive Engineer Water Works (Const.) City, Hydraulic Engineer's Department, B.M.C. Engineering Hub Building, First Floor, Dr. E Moses Road, Worli, Mumbai – 400018.

**This tender document is not transferable.**

The BMC reserves the rights to accept any of the application or reject any or all the application received for above subject without assigning any reason thereof.

Sd/-  
**Hydraulic Engineer**

**This page is intentionally kept Blank**

**SECTION 2**  
**ELIGIBILITY**  
**(POST QUALIFICATION)**  
**CRITERIA**



**POST QUALIFICATION CRITERIA****2.1 Technical Capacity**

The tenderer(s) in their own name should have satisfactorily completed the work of similar nature in BMC /Semi Govt. /Govt. & Public Sector Organizations during **last seven (7) years** ending last day of month previous to the date of issue of tender as a prime Contractor (or as a nominated sub-Contractor, where the subcontract had involved similar nature of work as described in the scope of works in this bid document, provided further that all other qualification criteria are satisfied).

- a) **Three similar completed works each** of value not less than the value equal to **30%** of estimated cost put to tender i.e. **Rs. 1006.63 Lakhs each.**

**Or**

- b) **Two similar completed works each** of value not less than the value equal to **35%** of estimated cost put to tender i.e. **Rs. 1174.39 Lakhs each.**

**Or**

- c) **One similar completed work** of value equal and or not less than the **50%** of estimated cost put to tender i.e. **Rs. 1677.71 Lakhs each.**

The value of completed works shall be brought to current costing level by enhancing the actual value of work at compound rate of 10 % per annum; calculated from the date of completion to the date of issue of tenders.

**\*In case of ongoing works to be considered, the bidder must have received payment bills of 80% of the contract sum for the work/works executed last day of month previous to the one in which bids are invited.**

**2.2 Financial Capacity**

Achieved an average annual financial turnover as certified by 'Chartered Accountant' (in all classes of civil engineering construction works only) equal to **30%** of the estimated cost i.e. **Rs. 1006.63 Lakhs** of work in last three (3) financial years immediately preceding the Financial Year in which bids are issued.

- **To ascertain this, tenderer(s) shall furnish /upload the financial statement (Audited balance sheet) duly certified by Chartered Accountant.**

- The value of completed works shall be brought to current costing level by enhancing the actual value of work at compound rate of 10 % per annum; calculated from the date of completion to the date of issue of tenders.

### 2.3 Similar Experience:

Similar Experience shall mean, completed works laying/ replacement/ rehabilitation of various dia. water pipe lines in Cast Iron/ Ductile Iron/ M.S. Pipes/ HDPE/ MDPE Pipes carrying water pressure and pressurized sewer mains and pressure pipe lines as rising main/ petroleum/ gas pipe lines.

### 2.4 Bid Capacity:

**The bid capacity of the prospective bidders will be calculated as under:**

**Assessed Available Bid Capacity = (A\* N\* 2 - B)**

Where,

**A** = Maximum value of Civil Engineering works completed in any one year (year means Financial year) during **the last five years** (updated to the price level of the Financial year in which bids are invited at a compounded rate of 10% per year) taking into account the completed works.

Enhancement of turnover up to level of 2024-2025 shall be done as per updating factors given below.

Updating factor for 2019-2020 is 1.46

Updating factor for 2020-2021 is 1.33

Updating factor for 2021-2022 is 1.21

Updating factor for 2022-2023 is 1.10

Updating factor for 2023-2024 is 1.00

**N** = Number of years prescribed for completion of the Project/Works, **excluding monsoon period**, for which these bids are being invited. (E.g. 7 months = 7/12 year) For every intervening monsoon 0.33 shall be added to N.

**B** = Value of existing commitments (**only allotted works**) on the last date of submission of bids as per bidding document and on-going works to be completed during the period of completion of the Project/Works for which these bids are being invited.

Note: The statement showing the value of existing commitments and on-going works as well as the stipulated period of completion remaining for each of the works listed should be attached along with



certificates duly signed by the Engineer-in Charge, not below the rank of an Executive Engineer or equivalent. Bid capacity calculated should be more than Cost of work put to tender.

**Even though the bidders meet the above qualifying criteria, they are subject to be disqualified if they have:**

- made misleading or false representation in the forms, statements and attachments submitted in proof of the qualification requirements; and/or
- Record for poor performance such as abandoning the works, not properly completing the contract, inordinate delays in completion, ~~litigation history~~, or financial failures etc



# **SECTION 3**

# **DISCLAIMER**



## **DISCLAIMER**

The information contained in this e-tender document or provided to Applicant(s), whether verbally or in documentary or any other form, by or on behalf of the Brihanmumbai Municipal Corporation (BMC), hereafter also referred as “The Authority “, or any of its employees or advisors, is provided to Applicant(s) on the terms and conditions set out in this e-tender and such other terms and conditions subject to which such information is provided.

This e-tender includes statements, which reflect various assumptions and assessments arrived at by the Brihanmumbai Municipal Corporation (BMC) in relation to the Project. Such assumptions, assessments and statements do not purport to contain all the information that each Applicant may require. This e-tender may not be appropriate for all persons, and it is not possible for the Brihanmumbai Municipal Corporation (BMC), its employees or advisors to consider the investment objectives, financial situation and particular needs of each party who reads or uses this e-tender. The assumptions, assessments, statements and information contained in this e-tender may not be complete, accurate, adequate or correct. Each Applicant should therefore, conduct its own investigations and analysis and should check the accuracy, adequacy, correctness, reliability and completeness of the assumptions, assessments, statements and information contained in this e-tender and obtain independent advice from appropriate sources.

Information provided in this e-tender to the Applicant(s) is on a wide range of matters, some of which may depend upon interpretation of law. The information given is not intended to be an exhaustive account of statutory requirements and should not be regarded as a complete or authoritative statement of law. The Brihanmumbai Municipal Corporation (BMC) accepts no responsibility for the accuracy or otherwise for any interpretation or opinion on law expressed here.

The Brihanmumbai Municipal Corporation (BMC), its employees and advisors make no representation or warranty and shall have no liability to any person, including any Applicant or Bidder, under any law, statute, rules or regulations or tort, principles of restitution or unjust enrichment or otherwise for any loss, damages, cost or expense which may arise from or be incurred or suffered on account of anything contained in this e-tender or otherwise, including the accuracy, adequacy, correctness, completeness or reliability of the e-tender and any assessment, assumption, statement or information contained therein or deemed to form part of this e-tender or arising in any way with pre-qualification of Applicants for participation in the Bidding Process. The Brihanmumbai Municipal Corporation (BMC) also accepts no liability of any nature whether resulting from negligence or otherwise howsoever caused arising from reliance of any Applicant upon the statements contained in this e-tender.

The Brihanmumbai Municipal Corporation (BMC) may, in its absolute discretion but without being under any obligation to do so, update, amend or supplement the information, assessment or assumptions contained in this e-tender.

The issue of this e-tender does not imply that the Brihanmumbai Municipal Corporation (BMC) is bound to select and short-list pre-qualified Applications for Bid Stage or to appoint the selected Bidder or Concessionaire, as the case may be, for the Project and the Brihanmumbai Municipal Corporation (BMC) reserves the right to reject all or any of the Applications or Bids without assigning any reasons whatsoever.

The Applicant shall bear all its costs associated with or relating to the preparation and submission of its Application including but not limited to preparation, copying, postage, delivery fees, expenses associated with any demonstrations or presentations which may be required by The Brihanmumbai Municipal Corporation (BMC) or any other costs incurred in connection with or relating to its Application. All such costs and expenses will remain with the Applicant and the Brihanmumbai Municipal Corporation (BMC) shall not be liable in any manner whatsoever for the same or for any other costs or other expenses incurred by an Applicant in preparation or submission of the Application, regardless of the conduct or outcome of the Bidding Process.

# **SECTION 4**

# **INTRODUCTION**





## INTRODUCTION

### **4.1 Background:**

The Brihanmumbai Municipal Corporation covers an area of 437.71 sq.kms. with a population of **1.24 Crores as per census of 2011**. The metropolis accounts major portion of India's international trade and government's revenue, from being one of the foremost centers of education, science and technological research and advancement.

The Mumbai Metropolis has historic tradition of strong civic activism dedicated to the cause of a better life for all its citizens. And it is the Brihanmumbai Municipal Corporation (BMC), hereafter called the "corporation", is the primary agency responsible for urban governance in Greater Mumbai.

BMC (The Authority) is one of the largest local self-governments in the Asian Continent. In observance of historic traditions of strong civic activism, with the change in time and living conditions to match with the urbanization, BMC has mainly focused in providing almost all kinds of engineering services viz, Hydraulics, storm water drain, sewerage, water supply projects, roads, bridges, solid waste management, and environmental services. Beside this, the BMC is also providing dedicated services in various segments such as Health, Primary Education as well as the construction and maintenance of Public Markets and Slaughter Houses.

BMC is an organization having different departments, right from engineering depts. to health depts. Moreover, BMC has have other dept. like education, market, fire brigade dept., Octroi and other such departments where quite a good number of staff members are working.



**SECTION 5**

**E-TENDERING ONLINE**

**SUBMISSION PROCESS**



**E-TENDERING ONLINE SUBMISSION PROCESS**

Refer the website <https://mahatenders.gov.in> under Bidders Manual Kit, for Instruction to Bidder.



**SECTION 6**  
**INSTRUCTIONS TO**  
**APPLICANTS**





## INSTRUCTIONS TO APPLICANTS

### 6.1 Scope of Application

The Authority wishes to receive Applications for Qualification in order to select experienced and capable Applicants for the Bid Stage.

### 6.2 Eligibility of Applicants

The Brihanmumbai Municipal Corporation (BMC) invites e-tender to appoint Contractor for the aforementioned work from contractors of repute, multidisciplinary engineering organizations i.e. eminent firm, Proprietary/Partnership Firms/ Private Limited Companies/ Public Limited Companies/Companies registered under the Indian companies' act 2013, the contractors registered with the Brihanmumbai Municipal Corporation (BMC) in **Class AA, category IV as per old registration and Class I (A) as per new registration** and from the contractors/firms equivalent and superior classes registered in Central or State Government/Semi Govt. Organization/Central or State Public Sector Undertakings, will be allowed subject to condition that, the contractors who are not registered with BMC will have to apply for registering their firm within three months' time period from the award of contract, otherwise their Bid Security i.e. **E.M.D (Earnest Money Deposit) will be forfeited/recovered and an amount equal to Registration Fee of respective class will be recovered as penalty.**

### 6.3 Classes available for Civil Contractors (As per old registration rules):

<i>Category</i>	<i>Description of work</i>
Building      C-I	Building & allied works, pile foundation, precast or cast in situ concrete works, diaphragm walls, ground anchors and allied works, water proofing, leak proofing of various types of structures.
Bridges          C-II	Bridges including road over bridges, flyover, foot over bridges, subways and culverts.
Roads            C-III	Road works of various types including storm water drains culverts and training/ de-silting of nallas, underground storm water drains.
<b>Water Supply C-IV</b>	<b>Laying of water mains, rising mains, water pumping stations, reservoirs, head works.</b>
Sewerage        C-V	Laying of sewers, rising main & underground storm water drains, sewage pumping stations, treatment plants, outfalls etc.

**6.4 Class available according to the limits of works, amount of solvency, registration fees & amount of standing deposit prescribed for each class (As per old registration rules).**

<i>Class</i>	<i>Works limit</i>	<i>Solvency amount</i>	<i>Scrutiny fees</i>	<i>Registration fees</i>	<i>Renewal fees</i>	<i>Standing deposit</i>
	<i>Rs</i>	<i>Rs</i>	<i>Rs</i>	<i>Rs</i>	<i>Rs</i>	<i>Rs</i>
		<i>In Lacs</i>				
<b>AA</b>	<b>Without limit</b>	<b>60</b>	<b>2000</b>	<b>4000</b>	<b>2000</b>	<b>7,50,000.00</b>
A	upto 3 Crores	30	2000	4000	2000	4,50,000.00
B	upto 1 Crore	20	1000	2000	1000	3,00,000.00
C	upto 50 Lacs	15	1000	2000	1000	1,50,000.00
D	upto 25 Lacs	10	1000	2000	1000	1,12,500.00
E	upto 10 Lacs	5	1000	2000	1000	45,000.00

**6.5 MINIMUM FINANCIAL AND ORGANIZATIONAL REQUIREMENTS FOR CIVIL ENGINEERING DISCIPLINE AS PER REFRAMED RULES**

<b>MINIMUM FINANCIAL AND ORGANIZATIONAL REQUIREMENTS FOR CIVIL ENGINEERING DISCIPLINE AS PER REFRAMED RULES</b>						
Sr. No.	Class	Upper limit of Tendering	Minimum Solvency	Total Turn-Over in Last 3 Years	Cost of Single Work Completed within Last 3 years	No. of Civil Engineers Employed
1	2	3	4	5	6	7
<b>1</b>	<b>I(A)</b>	<b>Without Limit</b>	<b>200</b>	<b>4000</b>	<b>1500</b>	<b>4 Graduate with 5 years or 1 Graduate with 5 years and 5 Diploma Holder with 7 years experience.</b>
2	I(B)	2500	175	2500	750	3 Graduate with 5 years or 1 Graduate with 5 years and 4 Diploma Holder with 7 years experience.
3	I(C)	1500	150	1500	300	3 Graduate with 5 years or 1 Graduate with 5 years and 4 Diploma Holder with 7 years experience.
4	II	750	100	750	150	2 Graduate with 3 years or 1 Graduate with 3 years and 3 Diploma Holder with 5 years experience.

5	III	300	75	300	90	2 Graduate with 3 years or 1 Graduate with 3 years and 2 Diploma Holder with 5 year-seperience.
6	IV	150	40	150	50	1 Graduate with 1 year or 1 Diploma Holder with 3 years experience.
7	IV(A)	90	25	90	30	1 Graduate with 1 year or 1 Diploma Holder with 3 year-seperience.
8	V	50	15	50	15	1 Graduate with 1 year or 1 Diploma Holder with 3 years experience.
9	V(A)	30	8	0	0	1 Fresh Graduate or 1 Fresh Diploma Holder.
10	VI	15	2	0	0	1 Fresh Graduate or 1 Fresh Diploma Holder.
11	VII	10	1	0	0	1 Fresh Graduate or 1 Fresh Diploma Holder.
12	VIII	5	0.5	0	....	1 Fresh Graduate or 1 Fresh Diploma Holder.
13	IX	3	0.25	.....	....	1 Fresh Graduate or 1 Fresh Diploma Holder.

Note:- 1) A Solvency Certificate registered beyond 12 months from the date of its issue will not be considered. Certificate of Solvency (in Hindi/Marathi/English) shall be obtained from scheduled or Nationalize Bank, in the name of the applicant/Firm/Company only.

2) Turn-over shall be supported with work completion/performance certificate of civil works only. In case of works carried out in private organization, T.D.S. Certificate is essential and certificate from License Architect is necessary.

3) Cost of single work criteria will be governed as given in below table

#### 6.6 SINGLE WORK CRITERIA (Rs. In Lakhs) (As per New registration rules)

SINGLE WORK CRITERIA					
Sr.No.	Class	Upper limit of Tendering	Single work criteria(Applicant has to fulfill one of the following criteria)		
			Minimum Cost of Single Work Completed (within Last 3 years)	Cost of Two Works Completed costing not less than (With- in Last 3 years)	Cost of Three Works Completed costing not less than (Within Last 3 years)
1	2	3	4	5	6
1	I(A)	<b>Without Limit</b>	<b>1500</b>	<b>750</b>	<b>500</b>
2	I(B)	2500	750	400	250
3	I(C)	1500	300	150	100
4	II	750	150	75	50
5	III	300	90	50	30
6	IV	150	50	25	20
7	IV(A)	90	30	15	10
8	V	50	15	8	5

## 6.7 Equipment Capabilities as required for this work

### Equipment Capability:

Sr.No.	Equipments owned/access to	Requirements (No.)		
		Regular and Routine works	New and Original Works	For other special works
1	2	3	4	
01	Pumps for dewatering	2 (15 BHP)	-	-
02	Submersible pumps for dewatering	5 (10BHP) & 3 (5 BHP)	-	-
03	Rock breaker with compressor	2	-	-
04	Crane	1		
05	Pipe cutter	4	-	-
06	Ratchet Drilling machine.	4	-	-
07	Roller Vibratory Min. 10T	2	-	-
08	Welding set.	5	-	-
09	Compressor	4	-	-
10	Transit Mixer (Tilted)	2	-	-
11	J.C.B.	2	-	-
12	Excavator / Poclain	1	-	-
13	Dumper / Trucks 8 Cu.m capacity	4	-	-
14	Dumper / Trucks 4 Cu.m capacity	4	-	-
15	C.C.T.V. Camera	1	-	-
16	Mobile D.G.set	2	-	-
17	Plate Vibrator	3	-	-

- a) **Regular and Routine works:** The successful bidder will make the arrangements of the required equipment on the day of commencement or with respect to the progress of the work in phases, as per the instructions of site in charge. The successful bidder and, to that effect he will ensure commitment on an undertaking on Rs.500 stamp paper to be submitted along with the Bid in Packet B. However, this condition in no way shall dilute the respective condition in Registration Rules of BMC.
- b) ~~**New and Original Works:** The bidder should, undertake their own studies and furnish with their bid, a detailed construction planning and methodology supported with assessment study of requirements of equipment/plants & machineries to allow the employer to review their proposal. The bidder will ensure his commitment to make the arrangements of the required equipment on the day of commencement or with respect to the progress of the work in phases, as per the instructions of site in charge on an undertaking on Rs.500 stamp paper to be submitted along with the Bid in Packet B. However, this condition in no way shall dilute the respective condition in Registration Rules of BMC.~~
- c) **Special Works:** ~~The concerned Ch.Eng. shall enlist the equipments in the tender document justified for the project and ensure the capacity of the bidder for the same with the approval of concerned AMC.~~

**Note:**

- 1. Bidders shall submit the undertaking for equipment capability and other undertakings as such on a single Rs.500/- stamp paper.-**

### 6.8 Technical Personnel

#### (A) General Guidelines for Fixing Requirement of Technical Staff

Cost of work (Rs in Crore)	Requirement of Technical Staff (of Major +Minor Component)		Minimum Expe- rience(years)	Designation
	Qualification	Number		
More than 50 to 100	i) Graduate Engineer	1	20	Project Manager
	ii) Graduate Engineer	1 + 1	12	Deputy Project Manager
	iii) Graduate Engineer OR Diploma Engineer	2 + 1	5 OR 10	Project/ Site Engineer
	iv) Graduate Engineer	1	8	Quality Engineer
	v) Diploma Engineer	1	8	Surveyor
	vi) Graduate Engineer	1 + 1	6	Project Planning/ Bill- ing Engineer
<b>More than 20 to 50</b>	<b>i) Graduate Engineer</b>	<b>1</b>	<b>20</b>	<b>Project Manager</b>
	<b>ii) Graduate Engineer</b>	<b>1</b>	<b>5</b>	<b>Project/Site Engineer</b>
	<b>Or</b>	<b>+</b>	<b>Or</b>	
	<b>Diploma Engineer</b>	<b>1</b>	<b>10</b>	<b>Quality Engineer</b> <b>Surveyor</b> <b>Project Planning/ Billing Engineer</b>
	<b>iv) Graduate Engineer</b>	<b>1</b>	<b>8</b>	
	<b>v) Diploma Engineer</b>	<b>1</b>	<b>8</b>	
<b>vi) Graduate Engineer</b>	<b>1</b>	<b>6</b>		
10 to 20	i)Project Manager with degree in corresponding discip- line of Engineering	1	10	Principal Technical Representative
	ii)Graduate Engineer	1	5	Technical Representa- tive
	iii) Graduate Engineer or Diploma Engineer	2	2	Project/Site Engineer and Project Planning/ billing Engineer
		2	5	
5 to10	i) Graduate Engineer	1	5	Principal Technical Representa- tive

	ii) Graduate Engineer or Diploma Engineer	2	2	Project/ Site Engineer
		2	5	Billing Engineer
More than 1.5 to 5	i) Graduate Engineer	1	5	Principal Technical Representative
	ii) Graduate Engineer or Diploma Engineer	1	2	Project/Site Engineer
		1	5	Billing Engineer
Up to 1.5	i) Graduate Engineer or Diploma Engineer	1	2	Principal Technical Representative
		1	5	Project/Site Engineer/ Billing Engineer

**Notes- 1.** “Cost of work”, in table above, shall mean the agreement amount of the work..

**2.** Rate of recovery in case of non-compliance of the clause be stipulated at following rates:-

Sr. No	Qualification	Experience(years)	Rate of Recovery
1	Project Manager with degree	20	Rs.60000/-p.m.
2	Deputy Project Manager with degree	12	Rs.40000/-p.m.
3	Project/Site Engineer (Degree/Diploma)	5 or 10 respectively	Rs.25000/-p.m.
3	Quality Graduate Engineer	8	Rs.25000/- p.m.
4	Surveyor	8	Rs.15000/- p.m.
5	Project Planning/ Billing Engineer	6	Rs.20000/- p.m.

3. Nothing extra need to be added while preparing market rate justified amount of the work if stipulation is made as per above recommended scale of technical staff.
4. Requirement of technical staff and their experience can be varied depending upon cost and complexity of the work by competent authority i.e. Chief Engineer with recorded reasons.
5. The failure in providing experienced technical and /professional ability personnel and even ignoring the instruction of the Engineer-in-charge shall be linked to penalization. Such disobeying attitude of the contractor shall also be reported to Vigilance/Registration & Monitoring department

## **6.9 TIME PERIOD OF THE PROJECT:**

Entire project should be completed and delivered **within 24 Months (Excluding Monsoon)** of time from the date of award of contract **that excludes monsoon**. The time allowed for carrying out the work as entered in the Tender shall be strictly observed by the Contractor and shall be reckoned from the date on which the Letter of Acceptance is given to the Contractor. The work shall throughout the stipulated period of the Contract be proceeded with all due diligence as time being deemed to be the essence of the contract on the part of the Contractor. On failing to do so, the Contractor shall pay as compensation an amount which shall be governed as per Clause - 8(e) of Standard General Conditions of Contract.

~~The Contractor should complete the work as per phase given below :~~

~~¼ of the work in ¼ of the time~~

~~½ of the work in ½ of the time~~

~~¾ of the work in ¾ of the time~~

~~Full of the work in Full of the time~~

Full work will be completed in **24 months Excluding Monsoon**.

The programme for completion of work shall be a part of the Contract Document in the form of Bar Chart / Gantt chart. The Contractor is supposed to carry out the work and keep the progress as per Bar Chart/GANTT Chart. The Contractor shall complete the work as per the Schedule given in the Contract and special condition the programme submitted by the Contractor.

## **6.10 Contract Execution**

All required documents for execution of the contract shall be submitted within 30 days from the date of issue of letter of acceptance. If the documents are not submitted within the stipulated time a penalty of **Rs 5000/- per day** will be applicable to the contractor. All contract documents need to be duly affixed with stamp duty properly signed along with evidence/proof of payment of security/contract deposit/ within 30 days from the date of letter of acceptance received by him.

**6.11** If the amount of the Contract Deposit to be paid above is not paid within **30 days** from the date of issue of Letter of Acceptance, the Tender / Contractor already accepted may be considered as cancelled and legal steps be taken against the contractor for recovery of the amounts.

**6.12** The amount of Security Deposit retained by the BMC shall be released after expiry of period up to which the contractor has agreed to maintain the work in good order is over. In the event of the contractor failing or neglecting to complete the rectification work within the period up to which the

contractor has agreed to maintain the work in good order, the amount of security deposit retained by BMC shall be adjusted towards the excess cost incurred by the Department on rectification work.

**6.13 Action when whole of security deposit is forfeited:**

In any case in which under any Clause of this contract, the contractor shall have rendered himself liable to pay compensation amounting to the whole of this security deposit whether paid in one sum or deducted by instalments or in the case of abandonment of the work owing to serious illness or death of the contractor or any other cause, the Engineer on behalf of the Municipal Commissioner shall have power to adopt any of the following process, as he may deem best suited to the interest of BMC -

- (a) To rescind the contract (for which recession notice in writing to the contractor under the head of Executive Engineer shall be conclusive evidence) and in that case, the security deposit of the contract shall stand forfeited and be absolutely at the disposal of BMC.
- (b) To carry out the work or any part of the work departmentally debiting the contractor with the cost of the work, expenditure incurred on tools and plant, and charges on additional supervisory staff including the cost of work-charged establishment employed for getting the un-executed part of the work completed and crediting him with the value of the work done departmentally in all respects in the same manner and at the same rates as if it had been carried out by the contractor under the terms of his contract. The certificate of the Executive Engineer as to the costs and other allied expenses so incurred and as to the value of the work so done departmentally shall be final and conclusive against the contractor.
- (c) To order that the work of the contractor be measured up and to take such part thereof as shall be un-executed out of his hands, and to give it to another contractor to complete, in which case all expenses incurred on advertisement for fixing a new contracting agency, additional supervisory staff including the cost of work charged establishment and the cost of the work executed by the new contract agency will be debited to the contractor and the value of the work done or executed through the new contractor shall be credited to the contractor in all respects and in the same manner and at the same rates as if it had been carried out by the contractor under the terms of his contract. The certificate of the Executive Engineer as to all the cost of the work and other expenses incurred as aforesaid for or in getting the un-executed work done by the new contractor and as to the value of the work so done shall be final and conclusive against the contractor.

In case the contract shall be rescinded under Clause (a) above, the contractor shall not be entitled to recover or be paid any sum for any work there for actually performed by him under this



contract unless and until the Executive Engineer shall have certified in writing the performance of such work and the amount payable to him in respect thereof and he shall only be entitled to be paid the amount so certified. In the event of either of the courses referred to in Clause (b) or (c) being adopted and the cost of the work executed departmentally or through a new contractor and other allied expenses exceeding the value of such work credited to the contractors amount of excess shall be deducted from any money due to the contractor, by BMC under the contract or otherwise, howsoever, or from his security deposit or the sale proceeds thereof provided, however, the contractor shall have no claim against BMC even if the certified value of the work done departmentally or through a new contractor exceeds the certified cost of such work and allied expenses, provided always that whichever of the three courses mentioned in clauses (a), (b) or (c) is adopted by the Executive Engineer, the contractor shall have no claim to compensation for any loss sustained by him by reason of his having purchase or procured any materials or entered in to any engagements or made any advance on account of or with a view to the execution of the work or the performance of the contract.

**6.14 Contract may be rescinded, and security deposit forfeited for bribing a public officer or if contractor becomes insolvent.**

If the contractor assigns or sublets his contracts or attempt so to do, or become insolvent or commence any proceeding to get himself adjudicated and insolvent or make any composition with his creditors, or attempt so to do or if bribe, gratuity, gift, loan, perquisite, reward or advantage, pecuniary or otherwise, shall either directly or indirectly be given promised or offered by the contractor or any of his servants or agents through any public officer, or person in the employ of BMC/Govt. in any way relating to his office or employment, or if any such officer or person shall become in any way directly or indirectly interested in the contract the Engineer In-charge may thereupon, by notice in writing rescind the contract and the Security Deposit of the Contractor shall thereupon stand forfeited and be absolutely at the disposal of BMC and the same consequences shall ensue as if the contract had been rescinded under above clause J hereof; and in addition the contractor shall not be entitled to recover or be paid for any work therefore actually performed under the contract.

## 6.15 Submission of Tenders

### PACKET – A

The Packet 'A' shall contain scanned certified copies of the following documents

Scrutiny of this packet will be done strictly with reference to only the scanned copies of Documents uploaded online in packet 'A'

- a) Valid Registration Certificate.
- b) Valid Bank Solvency Certificate of Minimum Solvency amount as governed by Registration Rules in force for respective Class of Contractor for Civil and M&E works.
- c) A document in support of registration under "The Central Goods and Services Tax (GST) Act 2017".
- d) Certified copies of valid 'PAN' documents and photographs of the individuals, owners, Karta of Hindu undivided Family, firms, private limited companies, registered co-operative societies, partners of partnership firms and at least two Directors, if number of Directors are more than two in case of Private Limited Companies, as the case may be. However, in case of Public Limited companies, Semi Government Undertakings, Government Undertakings, no 'PAN' documents will be insisted.
- e) Latest Partnership Deed in case of Partnership firm duly registered with Chief Accountant (Treasury) of BMC.
- f) The Registered power of attorney shall be submitted in the name of person who is submitting the bid.
- g) Scan copy of online paid EMD receipt.
- h) The bidders shall categorically provide their Email-ID in packet 'A'.

#### **NOTE:**

- **If the tenderer(s) withdraw tender offer during the tender validity period, his entire E.M.D shall be forfeited.**
- **The tenderer shall pay entire amount of EMD/Bid Security as specified in the bid amounting, through online payment gateways of GoM on URL <https://mahatenders.gov.in> . Any bid not accompanied by an acceptable Bid Security shall be rejected as non-responsive.**
- **If it is found that the tenderer has not submitted required curable documents in Packet "A" then, the shortfalls will be communicated to the tenderer through e-mail only and compliance required to be made within a time period of three working days otherwise they will be treated as non-responsive.**

**PACKET – B**

**The Packet ‘B’ shall contain scanned certified copies of the following documents –**

- a) The list of similar type of works as stated in para ‘A’ (Clause No. 2.1) of Post qualification successfully completed during the last Seven (07) years in prescribed proforma, in the role of prime contractor. Information furnished in the prescribed Proforma (**Proforma – I**) shall be supported by the certificate duly self-attested. Documents stating that it has successfully completed during the last Seven (07) years at least one contract of similar works as stated in para ‘A’ of Post qualification.
- b) **Annual financial turnover for preceding three financial years as certified by Chartered Accountant preceding the Financial Year in which bids are invited. Copies of Applicants duly audited balance sheet and profit and loss account for the preceding three financial years preceding the Financial Year in which bids are invited. (Proforma – II).**
- c) List of similar works as per Proforma.(**Proforma – III**).
- d) Documents stating that, it has access to or has available liquid assets, unencumbered assets, lines of credit and other financial means (independent of any contractual advance payment) sufficient to meet the construction cash flow requirements for the subject contract in the event of stoppage, start-up, or other delay in payment, of the minimum **15%** of the cost of the work tendered for, net of the tenderer's commitment of other contracts (Certificate from Bankers / C.A./Financial Institution shall be accepted as a evidence).
- e) The bidder shall give undertaking on Rs 500/-stamp paper that it is his/their sole responsibility to arrange the required machineries either owned/on lease or hire basis, at site before start of the work **(as per Proforma – V/C & VIII)**.
  - i) **Regular and Routine works:** The successful bidder shall make the arrangements of the required equipment on the day of commencement or with respect to the progress of the work in phases, as per the instructions of site in charge. The successful bidder and, to that effect he will ensure commitment on an undertaking on Rs.500 stamp paper to be submitted along with the Bid in Packet B. However, this condition in no way shall dilute the respective condition in Registration Rules of BMC.
  - ii) ~~**New and Original Works:** The bidder should, undertake their own studies and furnish with their bid, a detailed construction planning and methodology supported with assessment study of requirements of equipment/plants & machineries to allow the employer to review their proposal.~~

~~The bidder shall ensure his commitment to make the arrangements of the required equipment on the day of commencement or with respect to the progress of the work in phases, as per the instructions of site in charge on an undertaking on Rs.500 stamp paper to be submitted along with the Bid in Packet B. However, this condition in no way shall dilute the respective condition in Registration Rules of BMC.~~

- f. The list of the 'Technical Personnel's with their qualification, working in the tenderer's establishment as per **Proforma IV**.
- g. Details of works in hand and for which bid already submitted (**Proforma VI-A & VI-B**) (original), along with copies of work orders & attested copies of percentage of works completed or part thereof.
- h. Statement showing assessed available Bid Capacity.
- i. The undertakings on Rs.500/- **stamp paper** as per the Proforma annexed in Annexure **B** (Pre-Contract Integrity pact), **C** (Indemnity bond), **E** (Best price) and Annexure **I** (Irrevocable Undertaking).
- j. Undertaking on Rs.500/- stamp paper stating that tenderer is conversant to all site situation and difficulty & has inspected the site personally and accordingly bid is submitted.
- k. Annexure- **G** and Annexure- **H**
- l. Tenderer shall submit the undertaking stating that he will submit license certificate from the office of Labour Commissioner as stated in clause no 6.32, after issue of work order and before commencing the work, if the work is allotted to him.
- m. Details of litigation history in which tenderer is involved (Proforma IX) for last five years from the date of submission of bid as per directions given in the circular u/no. MGC/F/6565 dated 25.09.2018. at pg.no. 255-256**
- n. Details of certificate issuing Authorities in (**Proforma X**).
- o. Pre bid meeting minutes, signed copy of Addendum/ corrigendum if any.
- p. The tenderers shall upload work plan as per the following outline:
  - 1) GANTT chart/ PERT/ CPM chart showing the completion of work within prescribed time period, considering major activities.
  - 2) Organizational set up envisaged by the contractors.
  - 3) Plant & equipment proposed to be deployed for this work.
  - 4) Site Offices and Laboratories proposed to be set up.
  - 5) A note on how the whole work will be carried out (work plan including methodology).
  - 6) Quality management plan.
  - 7) All the activities included in the Scope of Work shall be covered in the work plan.
- q. **Annexure** for Grievance Redressal Mechanism attached at **page. 274-276.**

~~r. The tenderers have to submit undertaking on Rs. 500/- stamp papers with Manufacturer mentioning particular work name for uninterrupted supply of DI pipes and DI fittings as annexed at page 289-290.~~

**Note:**

- i. Bidders shall submit the undertaking for equipment capability and other undertaking as such on a single Rs.500/- stamp paper.**
- ii.** The Electrical / Mechanical work shall be got carried out by the civil contractors through the contractors registered with BMC in Electrical Category. Information about the registered contractors shall be obtained from the office of the Ch.E. (M&E)/ E.E. (Monitoring & Registration Cell). Attested scanned copy of the valid registration certificate in Electrical Category shall be uploaded with the tender along with the undertaking from the registered Electrical Contractor stating his willingness to carry out the tender work.
- iii.** The successful bidder shall submit valid registration certificate under E.S.I.C., Act 1948, if the tenderer has more than 20 employees/persons on his establishment (in case of production without use of energy) to BMC as and when demanded. In case of less employees/persons mentioned above then the successful bidder has to submit an undertaking to that effect on Rs. 500 stamp paper as per circular u/no. CA/FRD/I/65 of 30.03.2013.
- iv.** The successful bidder shall submit valid registration certificate under E.P.F. & M.P., Act 1952, if tenderer has more than 20 employees/persons on his establishment, to BMC as and when demanded. In case if the successful bidder has less employees/persons mentioned above then the successful bidder has to submit an undertaking to that effect on Rs. 500 stamp paper as per circular u/no. CA/FRD/I/44 of 04.01.2013.
- v.** The successful bidder shall submit the **signed form of the tender**, specification of works if any, **Annexure “A”** and the schedule of rates.
- vi. If it is found that the tenderer has not submitted required curable documents in Packet “B” then, the shortfalls will be communicated to the tenderer through e-mail only and compliance required to be made within a time period of three working days otherwise they will be treated as non-responsive.**
- vii.If the bidder is found non responsive after scrutiny of packet ‘A’/’B’ in such circumstances, the bidder will be made non-responsive and financial packet ‘C’ of non-responsive bidder will not be opened. However, there will not be any forfeiture of EMD.**

**PACKET – C**

- a. Online tender filled in percentage either plus or minus (Excess or less). There is no separate provision to quote % in physical form for packet 'C', tenderers will fill data in 'Financial' folder during the submission of the bid.

**As per circular u/no. CA/Finance/Project/City/28 dt. 10.11.2017, the condition for submission of Special Annexure-I is deleted.**

**Note: 1) In case of rebate/premium of 15% and above as quoted by the tenderer, the rate analysis of major items shall be submitted by L1 and L2 bidder after demand notification by e-mail to bidders by concerned E.E.W.W.(Const.). The format for rate analysis is annexed at Annexure D.**

**2) Rate analysis in prescribed format shall be submitted online to the Engineer in charge within 3 working days from the date of communication on email, failing which EMD will be forfeited, and the bid will be rejected, and the next Successful /Responsive bidder will be considered thereafter, negotiation will be done with the said successive/responsive bidder with respect to his quoted rate.**

**6.16 BID SECURITY OR EMD**

1. The Bidder shall furnish, as part of the Bid, Bid Security/EMD, in the amount specified in the Bid Data Sheet. This bid security shall be in favor of the authority mentioned in the Bid Data Sheet and shall be valid till the validity of the bid.
2. The tenderer shall pay entire amount of EMD/Bid Security as specified in the bid amounting, through online payment gateways of GOM on URL <https://mahatenders.gov.in> . The bidder shall upload scan copy of online paid EMD along with the bid submission in Packet A as per the directions given in the circular u/no. CA/Finance/Project/19 dated 04.03.2024 at **pg. 290-292.**
3. Any bid not accompanied by an acceptable Bid Security and not secured as indicated in sub-clause mentioned above, shall be rejected by the Employer as non-responsive.
4. The Bid Security/ EMD of the successful bidder will be discharged when the bidder has signed the agreement and furnished the required security Deposits.
5. Except successful bidder all other unsuccessful bidder's 100% EMD paid online will be re-funded automatically.

6. ASD of L-2 and other higher bidders (L-3, L-4, etc.) shall be refunded immediately after opening of financial bid.

**The Bid Security may be forfeited:**

- a. If the Bidder withdraws the Bid after bid opening (opening of technical qualification part of the bid during the period of Bid validity);
- b. In the case of a successful Bidder, if the Bidder fails within the specified time limit to:
- i. sign the Agreement; and/or
  - ii. Furnish the required Security Deposits.
- c. In case of non-workable rate analysis and misleading information submitted by the bidder, EMD shall be forfeited and bid will be rejected.**

1. The cases wherein if the curable shortfalls are not complied by a contractor, will be informed to Registration and Monitoring Cell. Such non-submission of documents will be considered as 'Intentional Avoidance' and if three or more cases in 12 months are reported, shall be viewed seriously and disciplinary action against the defaulters such as banning/de-registration, etc. shall be taken by the registration cell with due approval of the concerned AMC.
2. **Maximum 5 shortfalls of curable defects in packet A & packet B shall be allowed** and in case, curable defects are not complied by bidder, within given time period, the bidder shall be treated as '**Non-Responsive**' & such cases will be informed to **Registration and Monitoring Cell**. Such non-submission of documents will be considered as 'Intentional Avoidance' and if three or more cases in 12 months are reported, shall be viewed seriously and disciplinary action against the defaulters such as banning/de-registration, etc. shall be taken by the Registration Cell with due approval of the concerned AMC as per the directions given in the circular u/no. CA/Finance/Project/19 dated 04.03.2024 at pg. no.286 to 288.

**i) Curable Defect shall mean shortfalls in submission such as:**

**a. Non-submission of following documents,**

- I. Valid Registration Certificate**
- II. Valid Bank Solvency**
- III. Sales Tax Registration Certificate (VAT) / Central Goods and Services Tax (GST) registration certificate.**
- IV. Certified Copies of PAN documents and photographs of individuals, owners, etc.**

V. Partnership Deed and any other documents.

VI. Undertakings as mentioned in the tender document.

VII. Wrong calculations of Bid Capacity

ii) **Non-curable Defect shall mean**

a. **In-adequate submission of EMD/ASD amount,**

b. **In-adequacy and non-submission of technical and financial capacity with respect to Eligibility criteria as stipulated in the tender.**

c. **No proper submission of experience certificates and other relevant documents, etc.**

#### **6.17 BID VALIDITY**

a) **Bids shall remain valid for a period of not less than one eighty (180) days after the deadline date for bid submission specified in Bid Data Sheet. A bid valid for a shorter period shall be rejected by the Employer as non-responsive.**

b) In exceptional circumstances, prior to expiry of the original time limit, the Employer may request that the bidders may extend the period of validity for a specified additional period. The request and the bidders' responses shall be made in writing or by cable. A bidder may refuse the request without forfeiting his Bid Security. A bidder agreeing to the request will not be required or permitted to modify his bid, but will be required to extend the validity of his bid security for a period of the extension.

#### **6.18 DEFECT LIABILITY PERIOD**

i) The Contractor is expected to carry out the construction work in Workmen like manner so as to meet the requirement and specification for the project. It is expected that the Workmanship and materials will be reasonably fit for the purpose for which they are required.

j) Defects or defective work is where standard and quality of workmanship and materials as specified in the contract is deficient. Defect is defined as a failure of the completed project to satisfy the express or implied quality or quantity obligations of the construction contract. Defective construction works are as the works which fail short of complying with the express descriptions or requirements of the contract, especially any drawings or specifications with any implied terms and conditions as to its quality, workmanship, durability, aesthetic, performance or design. Defects in construction projects are attributable to various reasons.

k) Some of the defects are structural defects results in cracks or collapse of faulty defective plumbing, inadequate or faulty drainage system, inadequate or faulty ventilation, cooling or heating systems, inadequate fire systems etc. The defects could be various on accounts of different reasons for variety of the projects.



- l) The Engineering In charge/Project Officer shall issue the practical completion certificate for the project. During the Defect Liability Period which commences on completion of the work, the Engineering In charge shall inform or the contractor is expected to be informed of any defective works by the Employer's representative of the defects and make good at contractor's cost with an intention of giving opportunity to the contractor of making good the defects appeared during that period. It is the contractor's obligation under the contract to rectify the defects that appear during Defect Liability Period and the contractor shall within a reasonable time after receipt of such instructions comply with the same at his own cost. The Engineering In charge/Project Officer shall issue a certificate to that effect and completion of making good defects shall be deemed for all the purpose of this contract to have taken place on the day named in such defect liability certificate.
- m) If defective work or workmanship or design have been knowingly covered-up or concealed so as to constitute fraud, commencement of the Defect Liability Period may be delayed. The decided period may be delayed until **discover** actually occurs on at least the defect could have been discovered with reasonable diligence, whichever is earlier.
- n) The DLP shall be as below:

Dept.	Type of works	DLP
A) HE Dept.	1. For laying of CI/DI/MS/MDPE WM upto and including 300mm dia. and allied works as specified	1 year
	2. For work of laying of water main of size more than 300mm diameter and allied works as specified	3 years
	3. Leakage & contamination & allied works including reinstatement works	1 year
	4. Renewal of service connections	1 year
	5. Removal of bunch of connection	1 year
	6. Repair/ construction of valve chambers	1 year
	7. For separate independent tender for road/ trench works like: Asphalt mix Paver block C. C. road	3 years 3 years 5 years
B). Reinstatement work	8. DLP of Trenching Reinstatement work of various activities (as per RI tender floated by Road Department for reinstatement of trenches taken by various external and internal utilities in Greater Mumbai Z-1 to Z-VII)  B) Carriageway:	

Dept.	Type of works	DLP
	1. For Asphalt Work	3 Years
	2. Paver Blocks	3 Years
	3. Mastic Works	3 Years
	4. UTWT/TWT Works	3 Years
	5. CC Passage/CC Side strip	3 Years
	6. CC Road	3 Years
	<b>Footpath :</b>	
	<del>Improvement of footpath in gray or any specified color with short blasted paver block.</del>	<del>3-year</del>
	<del>In plain cement concrete (M 40) In stamp / stencil concrete (M 40) In CC with marble chip finish (M 40)</del>	<del>5-years</del>

❖ The above is illustrative. In case of any type of work not covered in above or any change in DLP, the concerned Ch. Eng. shall stipulate DLP with approval of concerned DMC/AMC.

❖ In case of composite works i.e. having combinations of construction activities of different disciplines, the DLPs shall be approved by AMC.

- o) Also, in case of defect, the Engineer shall give notice to the Contractor of any Defects before the end of the Defects Liability Period, which begins at. The Defects Liability Period shall be extended for as long as Defects remain to be corrected. Every time notice of Defect/Defects is given, the Contractor shall correct the notified Defect/Defects within the duration of time specified by the Engineer's notice. The Engineer may issue notice to the Contractor to carry out removal of defects or deficiencies, if any, noticed in his inspection, or brought to his notice. The Contractor shall remove the defects and deficiencies within the period specified in the notice and submit to the Engineer a compliance report.
- p) It is the Completion Stage when the contractor has completed all of the works and fixed all of the defects that were on the list of issue by Engineer-in-charge. When this happens, the engineer must issue a 'Certificate of Completion'. On the issue of 'Certificate of Completion', the 'Defect Liability Period' starts. The contractor also must issue a 'Certificate statement' as an acknowledgment to the engineer not later than 14 days after the 'Certificate of Completion' has been issued. During the 'Defect Liability Period', the contractor has to obey all written instructions from the engineer to carryout repairs and fix any defects which appear in the Permanent Works. If the contractor does not ,due to his own faults finish the repair works or fix the defects by the end of 'Defect Liability Period', the 'Defect Liability Period' will continue until all works instructed by engineer is done.

q) In case of any lapse in maintenance, the penalties shall be recovered and if necessary the work shall be got done at the risk and cost of the contractor after the prescribed period. The said cost shall be recovered from the Contract Deposit /Retention money or any other deposits, dues with the B.M.C. The contractor shall be liable to pay the excess cost if incurred, punitive damages and face penal action in the case of insufficiency of the aforesaid amount.

**6.19 SECURITY DEPOSIT AND PERFORMANCE GUARANTEE**

**A. Security Deposit**

The security deposit shall mean and comprise of

- I) Contract Deposit and
- II) Retention Money.

- i) **Contract Deposit – The successful tender, here after referred to as the contractor shall pay an amount equal to two percent (2%) of the contract sum shall be paid within thirty days from the date of issue of letter of acceptance. The said contract deposit shall be paid in the form of Demand draft (D.D) / Bank Guarantee.**
- ii) **Retention Money – The retention money equal to (5%) five percent of the Contract Sum, which will be recovered from the contracts or every bill i.e. interim / running / final bill. The clause of retention money will not be applicable M.&E. Department.**

**B. Additional Security Deposit**

The **additional security deposit** will be applicable when a rebate of more than of 12 % at the rate of with no maximum limit. The ASD is calculated as follows:

<b>Rebate quoted by Contractor</b>	<b>ASD Applicable</b>
For premium, at par and rebate 0 to 12%	<b>No ASD</b>
For rebate of 12.01% and above	At 2.00% of Estimated Cost for each % rebate & part thereof, in D.D. only.

Additional security deposit =  $(2X/100) \times$  office estimated cost,

Where X= percentage rebate quoted above 12%

**The bidders shall submit the ASD as applicable in the form of Demand Draft, which is to be submitted during office hours minimum one day before opening of packet ‘C’ to respective Head Clerk (Expenditure) of the Engineer in-charge of the HE Division in sealed envelope. If A.S.D. is not applicable then the bidders shall submit sealed envelope mentioning on their letter head ‘ASD is not applicable’.**

**If the bidders fails to submit the sealed envelope as mentioned above at least one day before**

opening of Packet ‘C’ within office hours then the EMD of the respective bidders will be forfeited and the company with their Directors/ Partners and other companies with the said Directors / Partner will be further debarred from any tendering process for the period of at least 2 years.

### **C. Performance Guarantee**

The successful tender, here after referred to as the contractor shall pay in the form of “Performance Guarantee” at different rates for different slabs as stated below:

Offer	PG applicable %
For premium, at par and rebate 0 to 12%	PG= 0.92% x contract sum <b>applicable for rebate of 12%</b>
For rebate of 12.01% and above	P.G. = {0.92% x contract sum applicable for rebate of 12%} +(X) x contract sum where X= percentage rebate quoted more than 12%

**Note: Contract sum shall mean amount after application of rebate/premium as quoted by the contractor with physical contingencies only and excluding price variation.**

The PG shall be paid in one the following forms.

- I) Cash (In case guarantee amount is less than Rs.10,000/- )
- II) Demand Draft (In case guarantee amount is less than Rs.1,00,000/-)
- III) Government securities
- IV) Fixed Deposit Receipts (FDR) of a Schedule Bank.
- V) An electronically issued irrevocable bank guarantee bond of any Schedule bank or f in the prescribed form given in Annexure.

Performance Guarantee is applicable over and above the clause of Security Deposit. Performance Guarantee will have to be paid & shall be valid till the defect liability period or finalization of final bill whichever is later. Performance Guarantee shall be submitted separately for different DLP’s of the work as mentioned in **Annexure A**. Amount of P.G. will be work out on the basis of proportionate cost of the work as per the DLP of that particular work.

**This deposit will be allowed in the form of I to V as mentioned above and shall be paid within 15 days after receipt of Letter of Acceptance.**

**Note:** Following exceptions shall be adopted for ‘Demolition Tenders’:

- i. Irrespective of the offer (Rebate/ at par/ premium), ASD shall be differed and only PG of 10% of contract sum be taken from the successful bidder on award of contract only.
- ii. BMC departments shall ensure to incorporate specific condition regarding above in bid document and e-tender notice.

### **D. Refund of Security Deposit**

#### **I. Refund of Contract Deposit**

The Contract Deposit shall be released within 30 days after completion of 3<sup>rd</sup> year of DLP (in case of 5 years DLP) and after issue of 'Defect Liability Certificate' (in case of 1 or 2 or 3 years DLP) subject to no recoveries are pending against the said work, provided that the Engineer is satisfied that there is no demand outstanding against the Contractor. No claim shall be made against the Balance Contract Deposit after the issue of Defects Liability Certificate.

## **II. Refund of Retention Money**

The Retention Money will be refunded after completion of defect liability period and after issue of "Defect Liability Certificate" (in case of 1 or 3 or 5 years DLP) provided that the Engineer is satisfied that there is no demand outstanding against the Contractor. In the event of different Defects Liability Periods have been specified or become applicable to different sections or parts of the Permanent Works, the said money will be released within 30 days on expiration of such Defects Liability Periods. In the event the Engineer issues a Taking-over Certificate for a section or part of the Permanent Works, only such proposition thereof as the Engineer determines (having regard to the relative value of such section or part of the Works) shall be considered by the Engineer for payment to the Contractor.

## **III. Refund of Additional Security Deposit**

One-half (50%) of the additional security deposited (ASD) shall be released after completion of 50% financial progress of the work.

The balance ASD shall be released within 30 days of issue of "Certificate of Completion" with respect to the whole of the work. In the event the Engineer issues a Taking-over Certificate for a section or part of the permanent works, only such proposition thereof as the Engineer determines (having regard to the relative value of such section or part of the works) shall be considered by the Engineer for Refund of ASD to the contractor.

## **IV. Refund of Performance Guarantee**

The Deposit on account of performance guarantee shall be released within 30 days of completion of Defects Liability Certificate subject finalization of final bill whichever is later and no recoveries are pending against the said work, provided that the Engineer is satisfied that there is no demand outstanding against the Contractor.

❖ Summary of time of Refund of deposit is tabulated as follows:

a) ~~Time of Refund for works having 5 years DLP~~

<del>Deposits refunded after 50% of financial progress</del>	<del>Deposits refunded after completion</del>	<del>After 3 yrs of DLP</del>	<del>After Completion of DLP</del>
<del>50% ASD</del>	<del>50% ASD</del>	<del>€D</del>	<del>RM+PG</del>

**b) Time of Refund for works having 1 or 2 or 3 years DLP**

Deposits refunded after 50% of financial progress	Deposits refunded after completion	After Completion of DLP
50% ASD	50% ASD	CD+ RM+PG

**\*Note:**

a) It shall be clearly mentioned that the BG shall be applicable for individual work/contract and clubbing of various contracts of the said contractor will not be allowed. In case of obtaining Bank Guarantee, it is necessary to mention that the same shall be valid further 6 months from the completion of defect liability period/ warranty period.

b) It shall be the responsibility of the bidder to keep the submitted B.G. "VALID" for the stipulated time period in the tender & in case of its expiry it will attract penalization.

c) Bank Guarantee should be issued by way of General Undertaking and Guarantee issued on behalf of the Contractor by any of the Nationalized or Scheduled banks or branches of foreign banks operating under Reserve Bank of India regulations located in Mumbai up to Virar & Kalyan. List of approved Banks is appended at the end of Instructions to Bidders (ITB). The Bank Guarantee issued by branches of approved Banks beyond Kalyan and Virar can be accepted only if the said Bank Guarantee is countersigned by the Manager of a Regional Branch of the same bank within the Mumbai City Limit categorically endorsing thereon that the said Bank Guarantee is binding on the endorsing Branch of the Bank or the Bank itself within Mumbai Limits and is liable to be enforced against the said Branch of the Bank or the bank itself in case of default by the Contractors furnishing the Bank Guarantee. The Bank Guarantee shall be renewed as and when required and/or directed from time to time until the Contractor has executed and completed the works and remedied any defects therein.

**E. Legal + Stationary Charges: (As per applicable circular)**

Successful tender shall pay the Legal Charges + Stationary charges as per Circular/26206 dtd. 31.08.2023 of Legal department as amended as below. (Applicable G.S.T. will be recovered over these charges)

Contract Cost in Rs.		Legal+ Stationery Charges from 01.09.2023 upto
upto	50,000/-	Nil
from	50,001/- to 1,00,00,000/-	At the rate of 0.10% of Contract Cost ( with respect to rounding off such amount to next hundredth multiple) plus GST at the rate of 18 % (Minimum: Rs. 1000/- plus GST and Maximum: Rs. 10000/- plus GST)
from	1,00,00,001/- to 10,00,00,000/-	Rs. 10,000/- for Contract Cost upto Rs. 1,00,00,000/- plus At the rate of 0.05 % of Contract Cost amount greater than Rs. 1,00,00,000/- ( with respect to rounding off such amount to next hundredth multiple) plus GST at the rate of 18 %
from	10,00,00,001/- & above	Rs. 55,000/- for Contract Cost upto Rs. 10,00,00,000/- plus at the rate of 0.01 % of Contract Cost amount greater than Rs. 10,00,00,000/- ( with respect to rounding off such amount to next hundredth multiple) plus GST at the rate of 18 %

The tenderers are requested to note that stationary charges as given in the table above will be recovered from the successful tenderer for supply of requisite prescribed forms for preparing certificate bills in respect of the work.

**F. Stamp Duty: (As per applicable circular)**

It shall be incumbent on the successful tenderer to pay stamp duty on the contract.

i. As per the provision made in Article 63, Schedule I of Bombay Stamp Act 1958, stamp duty is payable for “works contract” that is to say, a contract for works and labour or services involving transfer of property in goods (whether as goods or in some other form) in its execution and includes a sub-contract, as under :

(a)	Where the amount or value set forth in such contract does not exceed rupees ten lakh.	Five Hundred rupees stamp duty
(b)	Where it exceeds rupees ten lakhs	Five Hundred Rupees plus 0.10% of the amount above rupees Rs.10 Lakhs subject to maximum of R.25 Lakhs
(c)	Bank Guarantee: As per article 54 read with 40(b) of stamp duty act, stamp duty of 0.5% will	

be applicable to the all bank guarantee submitted also which are required to be renewed after expiry of time period.
--

- ii. The successful bidder within 30 days from the date of the work order for executing the contract work under reference shall enter into a contract agreement with the B.M.C by submitting the necessary / required documents to the satisfaction of the concerned Executive Engineer & Account Officer. The contract agreement shall be adjudicated for payment of stamp duty by the successful bidder and accordingly the successful bidder shall pay the stamp duty on the contract agreement within such time so as to ensure that the contract agreement is executed within the stipulated period as aforesaid. The cost worked out after adding the physical & cost contingencies shall be considered for computing the stamp duty charges to be paid for the contract agreement.
- iii. Further shortfall if any, in amount of stamp duty paid as against prescribed amount for the documents executed in Mumbai City & Mumbai Suburban District be recovered from the concerned work contractors and to deposit the deficit or unpaid Stamp Duty and penalty by two separate Demand Draft or Pay Order in favour of “Superintendent of Stamp, Mumbai” within 15 days from intimation thereof.
- iv. All legal charges and incidental expenses in this respect shall be borne and paid by the successful tenderer.

## 6.20 IMPORTANT DIRECTIONS

1. All the information uploaded shall be supported by the corroborative documents in absence of which the information uploaded will be considered as baseless and not accepted for qualification criteria. All the documents shall be uploaded with proper pagination. The page No. shall be properly mentioned in the relevant places.

The information shall be uploaded in the sequence as asked for with proper indexing etc. The Bidder shall be fully responsible for the correctness of the information uploaded by him.

2. Applicants/Bidders shall refer [portal.mcgm.gov.in/tenders](http://portal.mcgm.gov.in/tenders) for “The Manual of Bid-Submission for Percentage Rate/Item Rate Tender Document.” The detail guidelines for creation and submission of bid are available in the referred document.

Any queries or request for additional information concerning this TENDER shall be submitted by e-mail to [eeconstcity.he@mcgm.gov.in](mailto:eeconstcity.he@mcgm.gov.in) The subject shall clearly bear the following identification/ title: **"Queries/Request for Additional Information: Tender for (HE-C-CT-CCRD-06) Laying/Replacement of various dia. water mains due to proposed improvement of roads in cement concrete in C ward & D ward of city section (2024-2026).** Any changes in mail ID will be intimated on the portal.



3. In case of **Equal Percentage** of lowest bidders (L1), the allotment of work shall be done by giving 48 hrs (**2 working days**) from the day of opening of packet C **on same BID-Document number for re-quoting** and such development needs to be done by IT department. **Till such development is made; 'Sealed Bids' shall be called from the bidders quoting the same rates i.e. L1.**

In case of equal percentage of lowest bidders is obtained even after re-quoting, then the successful bidder will be decided by lottery system by concerned Ch.Eng./H.E.

*The bidder shall need to submit the additional ASD if applicable within 7 days after receipt of notification issued by concerned Chief Engineer. Also, the Performance Guarantee shall be paid in 15 days after receipt of Letter of Acceptance.*

#### **6.21 GENERAL DIRECTIONS TO TENDERERS:**

- 1 Firms with common proprietor / partner are connected with one another either financially or as master and servant or with proprietor / partner closely related to each other such as husband, wife, father / mother and minor son / daughter and brother / sister and minor brother / sister, shall not tender separately under different name for the same contract.
- 2 If it is found that firms as described in clause 6.21.1 have tendered separately under different names for the same contract all such tenders shall stand rejected and tender deposit of each such firm / establishments shall be forfeited. In addition, such firms / establishments shall be liable, at the discretion of the Municipal Commissioner, for further penal action including blacklisting.
- 3 If it is found that closely related persons as in clause 6.21.1 have submitted separate tenders under different names of firms, establishment but with common address for such establishment / firms and / or if such establishment firms though they have different address, are managed or governed by the same person / persons jointly or severally such tender shall be liable for action as in clause 6.21.2 including similar action against firms / establishment concerned.
- 4 If after award of contract, it is found that the accepted tenderer violates any of the clauses, 6.21.1, 6.21.2, 6.21.3 the contract shall be liable for cancellation at any time during its currency in addition to penal action against the contractors as well as related firms / establishments.
- 5 Tenderers should note in addition to the official address, they should furnish private residential address, mobile nos., email ids of the partners. Any fault in this respect may justify the rejection of Tender.
- 6 In the event of tender being accepted, full amounts of contract deposit must be paid and contract must be signed by all the partners of the firm and if one or more partners be not available for the purpose,

signatory must produce a Power of Attorney must be registered in the office of C.A (Finance) / C.A (Treasury) /C.A (WSSD).

7 In the case of a Joint Stock Company, the contract must be sealed with the seal of the company in the presence of and signed by the two Directors or by a person duly authorized to sign the contract for the Company by a power of attorney, such power being sealed and signed as aforesaid. All such power of attorney must be registered in the Municipal Office.

**8 Tenderers must distinctly understand:**

- a) That they will be strictly required to conform to the conditions of this contract as contained in each of its clauses and that the plea of "custom prevailing" will not on any account be admitted as an excuse on their part for infringement of any of the conditions.
- b) That no alternation or interpolation will be allowed to be made in any of the terms and conditions of this contract or in the Specification of in the Schedule, and that if any such alteration or interpolation be made by a Tenderer, his tender will, at the option of the Municipal Commissioner, either be rejected or to be treated as if no such alteration or interpolation has been made.
- c) That the full contract deposit must be paid within the time specified and the contract must be executed within the stipulated time frame by the successful tenderer.
- d) That a postponement of the payment of the full contract deposit or the execution of the contract will not be permitted by reason of the Corporation having in possession other deposits on account of other tenders or contracts, which deposit may be or become returnable to the tenderers and which they may wish to transfer as a deposit under this contract. Such transfers will not under any circumstances be permitted.

**6.22 Tenderers shall note that if the conditions of G.C.C. are in variance with the conditions contained in the tender document the conditions of the tender document shall prevail.**

**6.23 SITE INSPECTION**

Prior to submitting and uploading e-tender for the work the tenderer should visit and examine at the site of works and its surroundings at his own expense and obtain and ascertain for himself, on his own responsibility & risk all information, technical data etc. that may be necessary for preparing his bid and entering into a contract including, inter-alia, the actual conditions regarding the nature and conditions of site, availability of materials, labour, probable sites for Chowky/stores etc. and the extent of lead and lift required for the execution of the work over the entire duration of the contract, after taking into consideration local conditions, traffic restrictions, obstructions in work, if any allow all such extra expenses that are likely to be incurred due to any such conditions, restrictions, obstructions etc. in the quoted contract price for the work.

They shall obtain further clarification, if any, on any specific issue from the Office of the Executive Engineer Water Works (Const.) City, Hydraulic Engineer's Department, B.M.C. Engineering Hub Building, First Floor, Dr. E Moses Road, Worli, Mumbai – 400018. before submitting the tender. **Tenderers/Contractors should note and study the condition related to site constraints and its impact.**

#### **6.24 MODIFICATIONS IN TENDER DOCUMENT**

If B.M.C. considers it is necessary to carry out any modifications, in the tender documents and extend the closing date of the tender the same shall be made by an addendum. Copy of addendum will be uploaded on e-Tendering website <https://mahatenders.gov.in>. Each addendum shall be signed by the tenderer(s) and scanned copy of the same should be uploaded in Packet 'B'. The tenderer(s) shall not add or amend the text of any documents contained in tender document.

#### **6.25 TAXES AND DUTIES ON MATERIAL**

The tenderer shall quote inclusive of all taxes other than GST (Excluding GST), Levies, Duties, Cess etc as applicable at the time of bid submission. GST as applicable shall be paid separately on submission of bills/invoice.

Input Tax Credit of GST as available with the bidder will not be claimed separately by BMC. However, while quoting the rates benefit of Input Tax Credit or Exemptions shall be passed on to the BMC by way of equivalent reduction in quoted price.

**6.26** As per circular CA/Finance/Proj/city/17, dtd:-06.09.2017 “Chapter XXI-Miscellaneous, section 171(1) of GST Act, 2017 governs the ‘**Anti Profiting Measure**’ (AMP). As per the provision of this section, ‘Any reduction in rate of tax on any supply of goods or services or the benefit of input tax credit shall be passed on to the recipient by way of commensurate reduction in prices.’ Accordingly, the contractor should pass on the complete benefit accruing to him on account of reduced tax rate or additional input tax credit, to BMC. Further, all the provisions of GST Act will be applicable to the tender.

#### **6.27 SOLVENCY CERTIFICATE**

Tenderer(s) shall upload a scanned copy of latest solvency certificate for required amount from a bank of B.M.C approved list attached issued *maximum 12 (Twelve) months prior to due date of tender*. Latest solvency certificate shall be submitted in physical format if the tender is awarded to bidder.

#### **6.28 ERRORS AND DISCREPANCIES IN TENDER**

If tender contains errors in the Bill of Quantities such as computing mistakes, incorrect transfer etc. the Engineer will inform the tenderer(s) of such errors or discrepancies and rectify the errors or discrepancies and will re-total the amounts of Bill of Quantities. The foregoing procedure may be applied at any time prior to award of contract and the Engineer is not liable for any error or discrepancy which was not discovered during scrutiny of the tender.

**6.29 EVALUATION OF TENDER**

In comparing tenders, the corporation shall consider such factors as the efficiency and reliability of instrument and methods proposed, compliance with the specifications, quality and the tenderer's capacity to perform vis-à-vis the time of completion.

**6.30 AWARD OF CONTRACT**

Notification of award by way of work order prior to the tender validity period will be issued in writing to successful tenderer. The contract will be awarded to the best responsive tenderer(s) offering the lowest evaluated tender in conformity with the tender document. Corporation reserves right to accept/reject any or all tenders and to annul the tendering process at any time prior to award of contract.

Prior to the expiry of the Tender validity, the Corporation will notify the successful tenderer(s) by a letter that his tender has been accepted, if required. This letter herein after and in condition of contract called "The Letter of the Acceptance". Notification of Award will constitute the information of contract.

**6.31 DISPUTE**

In case of any claim, dispute or difference arising in respect of the contract such claim, dispute or difference shall be dealt with as per *G.C.C clause no. 13, as amended up to date.*

**6.32 Contract Labour (Regulation and Abolition Act 1970):**

The tenderer(s) should specifically note that the successful tenderer shall have to strictly comply with the entire statutory requirement under the provision of the Contract Labour (Regulation and Abolition) Rules 1970 and with the Maharashtra State Contract Labour (Regulation and Abolition) Rules 1971 and indemnify the Corporation against any claim(s) whatsoever.

**6.33** As per the Contract Labour (Regulation & Abolition) Act 1970, every contractor should obtain a license certificate from the office of Labour Commissioner situated at Commerce Center, Tardeo, near A.C market, Mumbai – 400 034.

- 6.34 An amount of 1% of the contract cost shall be deposited with the government of Maharashtra as per circular u/no BCA/2007/CN/788/Kamgar 7A dated 16.10.2009.
- 6.35 The tenderer shall submit the copy of Registration issued under Employees provident fund and Miscellaneous Provisions Act 1952.
- 6.36 The tenderer shall also submit the copy of registration certificate issued under Employees State Insurance Corporation (E.S.I.C Act 1948).
- 6.37 Tenderers are requested to take cognizance of Child Labour Act and take precaution not to employ Child Labour on site. *If Child Labour is found to be employed on the work, a penalty of Rs.5000/- on the spot will be imposed on the defaulting contractors and further action as deemed fit will be taken.*
- 6.38 The contract period shall be as mentioned in the tender notice. The period required for mobilization, procurement of material, traffic permission, other required permissions, erection of site office etc. complete shall be reckoned from the date of issue of work order.
- 6.39 **The project works, laying of water main work shall not be carried out during the monsoon period without prior sanction from competent authority.**
- 6.40 The rates for unforeseen fair and extra items for the works, which are available in the Unified Schedule of Rates of B.M.C, applicable to the tender, will be paid as per G.C.C. in force as Amended up to date by B.M.C.
- 6.41 The tender shall have to start & simultaneously carry out the works included in the tender at multiple locations or as directed by the engineer.
- 6.42 *As per circular no. CA/FRD-1/57 dated 13.03.2013 no amendments in the original scope of work will be made without specific prior approval of concerned A.M.C. /M.C. No permission will be granted in any circumstances, to execute any additional work in another ward, by using the savings in BOQ, without sanction of competent authority. Tenderer should strictly note this clause.*
- 6.43 The proposed subject tender work ,the water mains shall be laid by diverting, re-aligning, and Supporting etc any/all existing utilities as directed and in consultation with respective authorities such as B.E.S.T, Traffic Police, M.T.N.L, B.S.E.S,M.S.E.B, Tata Electric Co, Tata Power, Mahanagar Gas, Railway Authority, Forest Authority, Salt Dept., P.W.D, MBPT, Tata Power, M.M.R.D.A, M.S.R.D.C etc. All precautionary/preventive and safety measures shall be taken to avoid any mishaps/accidents with utilities, labours and public. Any damage to utilities and

consequences thereof shall be made good by the tenderer at his own risk and cost as directed by the authority/B.M.C.

**6.44** The subject tender water work is proposed on most busy road in Mumbai. There will be remote chances to get full closure of road. Intending tenderers have to carry out the work in phase wise manner by allowing moving heavy vehicular traffic nearby and abutting to existing concrete road/asphalt road, Bridge foundation & substructure, infrastructure of existing utility and infrastructure if any and safeguarding of the same shall be entirely tenderer's responsibility. All precautionary/preventive and safety measures shall be taken to avoid any caving underneath the pavement, side collapse & mishaps/accidents thereof. No extra claim will be entertained on this account. Any damage & consequences thereof shall be made good by the tenderer at his own risk and cost as directed by the authority/B.M.C.

**6.45** The tenderer should note that he has to provide adequate barricading, during the various activities concern with the completion of the work in all respect in view of the above mention site conditions while carrying out the work as per the design and drawing of the BMC.

**6.46** **BARRICADING**

*Bidder shall note that, "Barricading shall be provided free of cost as per circular vide u/no. MGC/F/6342 dated 05.05.2018 & as per Annexure I, II & III of standard drawings & specifications with slogans & department wise color codes to the excavated trenches as per site condition." No payment shall be made for barricading. The copy of circular in this regard is as below:*

*Note: As the latest circular u/no. साप्रचि/८८/मप, दिनांक: २८.०४.२०२२ tenderer shall be noted that the "Municipal Corporation of Greater Mumbai" should be replaced with "Brihanmumbai Municipal Corporation" on the barricades.*

## MUNICIPAL CORPORATION OF GREATER MUMBAI

## CIRCULAR

U/No.MGC/F/6342 dated 5.5.2018

**Sub.:** Revised guidelines regarding barricades being used during the execution of various infrastructure development projects by MCGM in Mumbai.

Various infrastructure development projects are being executed by MCGM for the betterment of citizens of Mumbai. During the course of execution of the projects, it is necessary to provide strong and secured barricading as a safety measure to avoid any mishaps as well as to avoid nuisance to vehicular and pedestrian traffic. Nowadays, the following types of barricades are being used exclusively in MCGM as per the convenience of various departments at different sites.

1. Water/sand fillable PVC Metro barricades.
2. RW 7.45 (G.I. sheets of 22 gauge fixed on 3 inch dia. Wooden bullies buried in existing road sufficiently)
3. RW 7.36 (G.I. sheets of 22 gauge fixed on MS Angle post buried in half the depth in drums of 20 litres capacity in 1:3:6 concrete)
4. Structural steel barricade for major trenches having depth more than 2.00 meters.

Thus from the above, it can be seen that there is no uniformity in provision of barricades as they are of different size and shape. Further it is also observed that the continuity is not maintained in providing the barricading keeping gaps in between thus endangering the safety of vehicular as well as pedestrian traffic. Also the barricades are not being cleaned, thus further adding to shabbiness. Further Mumbai being the financial capital of India, people from all over the world visit the city daily and to maintain good image of city the following decisions are taken.

- A) Only two type of barricades having department wise colour coding are proposed to be used depending upon the nature of work i.e. Minor and Major.
- i) **Minor works:** Barricading made out of 1.5 mm thick MS plate fixed on M.S. angle post/ frame of 65 mm X 65 mm X 6 mm having height of 1.5 m supported on as shown in Annex-I.
  - ii) **Major works:** Structural steel barricade made out of 1.50 mm thick M.S. Plate ISMB 250, ISLC 250X50mm and ISA 50mmX50mmX6 mm having of size 2.5 m X 2 m as shown in Annex-II.
- B) The department wise colour coding for the barricading shall be as under:-
- i) H.E. & W.S.P. department – **Blue**
  - ii) Roads, Traffic, Bridges and Coastal Roads department– **Yellow**
  - iii) S.P. & S.O department – **Green**
  - iv) S.W.D., Building Maintenance department & for ward works – **Red**
- C) The basic principle behind installing secured and continuous barricading is to ensure the safety of vehicular as well as pedestrian traffic and residents in the nearby vicinity of the project. Due to non-installation of appropriate barricades on sites if any mishap occurs leading to injury or loss of life, then the contractor and contractor's Engineer in-charge will be liable for the consequent action.
- D) During the course of execution of project, if it is noticed that the contractor has not provided barricading then a penalty of Rs.1000/- per meter per day will be imposed upon the contractor and will be deducted from the due Bill. This penalty shall be a part of penalty as per tender condition.
- E) Details of the work shall be prominently displayed on the central panel of the barricades along-with the Social Slogans as given in Annexure III and the Cycle of the same shall be maintained.
- F) The contractor shall provide and install the barricading alongwith the slogans printed as per the Annexure III, at his own cost and no payment will be made for this, however the contractor shall quote the bid accordingly by considering the cost of barricading.



The condition shall be included in the tender as given below. “  
Barricading shall be provided free of cost as per Circular vide U/No.MGC/F/6342 dated 5.5.2018 and as per Annexure I, II and III of Standard drawings and specifications with slogans and department wise colour codes.” The copy of circular will be attached to the tender as a part of tender document.

This circular will be applicable for the new tenders proposed to be invited from 01.06.2018 and also the corrigendum shall be attached to tenders which are uploaded. However, for the projects wherein the tenders are already invited, the barricading shall be provided strictly as per tender condition. All the details (Annexure I, II & III of Standard drawings and specifications with slogans and department wise colour codes, sketches and department wise colour coding) are uploaded on MCGM portal.

This circular shall come in force with immediate effect.

sd/- 20.4.2018  
(Shri V.P . Chithore)  
**Dir.(ES&P)**

sd/- 20.4.2018  
(Shri R. B. Bambale)  
**D.M.C.(S.E.)**

sd/- 21.4.2018  
(Shri Vijay Singhal)  
**A.M.C.(E.S.)**

sd/- 21.4.2018  
(Dr. Shri Sanjay Mukherjee)  
**A.M.C.(P.)**

sd/- 5.5.2018  
(Shri Ajoy Mehta)  
**M. C.**

sd/- 16.5.2018  
(Shri V.P . Chithore)  
**Dir.(ES&P)**

sd/- 16.5.2018  
(Shri P. R. Kadam)  
**D.M.C.(S.E.)**

A) Only two types of barricades having department wise colour coding are proposed to be used depending upon the nature of work i.e. Minor and Major as directed by Engineer In Charge.

- i. Minor works: Barricading made out of 1.5 mm thick MS plate fixed on M.S. angle post/ frame of 65 mm X 65 mm X 6 mm having height of 1.5 m supported on as shown in **Annexure-I**.

## ANNEXURE I

### A) Minor work

Providing, fabricating and installing the barricading made out of 1.5 m high M.S. Angle post of 65 mm X 65 mm X 6 mm with 1.5 mm thick M.S. Sheet of size 1.55 m X 1.2 m welded to the M.S. angle post/ frames and fixed to 75mm X 75mm X 6 mm angle base as shown in sketch for minor works , displaying of the social slogan as per the Annex - III, daily cleaning of the same to get better appearance and interlocking arrangement to ensure continuity in provision and to avoid gap in between etc complete and as directed by Engineer in-charge.

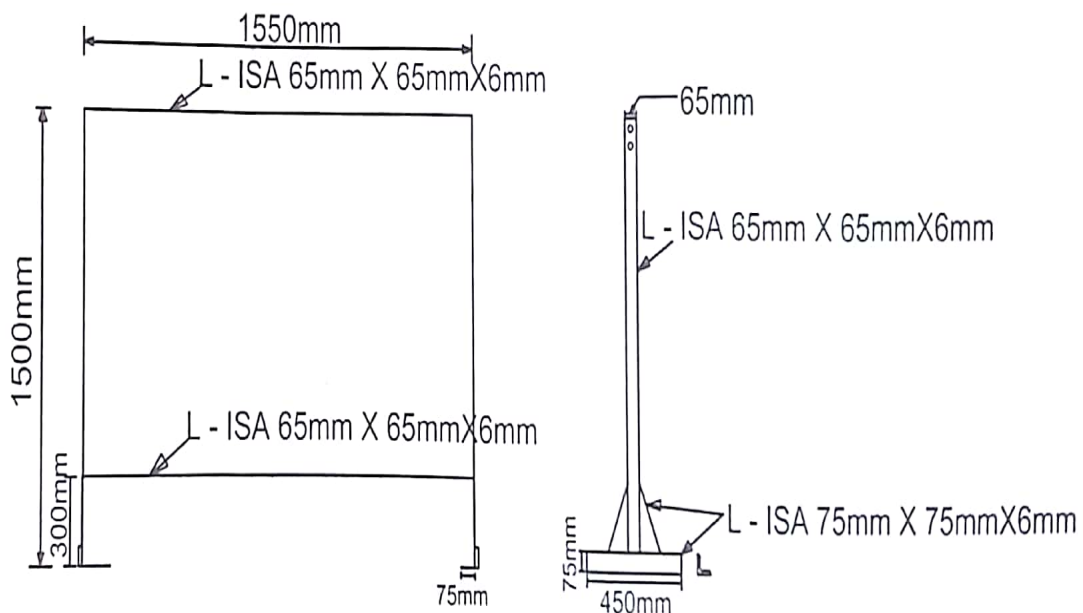

- ii. Major works: Structural steel barricade made out of 1.50 mm thick M.S. Plate ISMB 250, ISLC 250X50mm and ISA 50mmX50mmX6 mm having of size 2.5 m X 2 m as shown in **Annexure-II**.

## ANNEXURE II

### B) Major works:

Providing, fabricating and installing the structural steel barricading made out of 1.5 mm thick M.S. plate of size 2500 mm X 2000 mm, ISMC 250 X 50 channels, M.S. Angles ISA 50 X 50 X 6mm and ISMB 250 as per IS 1161-1 RHS/SHS rolled angle plates of TATA Steel, Lloyd Steel, SAIL, ESSAR steel approved in straight profile of all sizes, shapes and for all works including stiffeners, bolts and nuts, fillet / butt welding, splicing, machine grinding, of all member joints wherever required to give neat appearance, and daily cleaning the barricading along with displaying of the Depthwise slogans as given in Annexure -III etc with interlocking arrangement to avoid gap in between and as directed by Engineer in-charge.

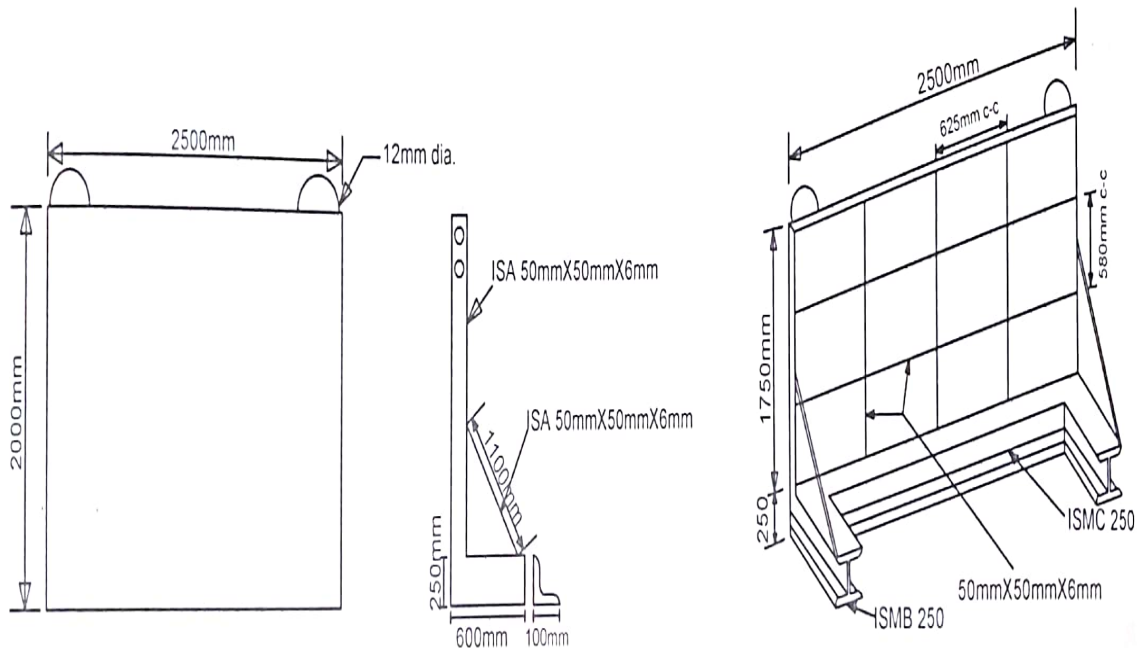

- B)** The department wise colour coding for the barricading shall be as under:-
- a. H.E. & W.S.P. department – Blue
  - b. Roads, Traffic, Bridges and Coastal Roads department– Yellow
  - c. S.P. & S.O department – Green
  - d. S.W.D., Building Maintenance department & forward works –Red
- C)** The basic principle behind installing secured and continuous barricading is to ensure the safety of vehicular as well as pedestrian traffic and residents in the nearby vicinity of the project. Due to non-installation of appropriate barricades on sites if any mishap occurs leading to injury or loss of life, then the contractor and contractor's Engineer in-charge will be liable for the consequent action.
- D)** During the course of execution of project, if it is noticed that the contractor has not provided barricading then a penalty of Rs.1000/- per meter per day will be imposed upon the contractor and will be deducted from the due Bill. This penalty shall be a part of penalty as per tender condition.
- E)** Details of the work shall be prominently displayed on the central panel of the barricades along-with the Social Slogans as given in Annexure III and the Cycle of the same shall be maintained.
- F)** The contractor shall provide and install the barricading along with the slogans printed as per the **Annexure III**, at his own cost and no payment will be made for this, however the contractor shall quote the bid accordingly by considering the cost of barricading.

ANNEXURE III

- 1) **HYDRAULIC ENGINEER'S DEPARTMENT/ WATER SUPPLY PROJECTS**
  - i) Inconvenience regretted
  - ii) Ensuring Mumbai's water supply
  - iii) Save water Save life
- 2) **ROAD, TRAFFIC / BRIDGES DEPARTMENT**
  - i) Inconvenience regretted
  - ii) Working towards a better tomorrow
  - iii) My Mumbai, Green Mumbai
- 3) **SEWERAGE PROJECTS DEPARTMENT/ SEWERAGE OPERATIONS DEPARTMENT**
  - i) Inconvenience regretted
  - ii) Reduce Reuse Recycle
  - iii) Clean Mumbai , healthy Mumbai
- 4) **STORM WATER DRAIN DEPARTMENT/ WARD WORKS**
  - i) Inconvenience regretted
  - ii) Working towards a better tomorrow
  - iii) Swatch Bharat

Specifications with Slogans & Department wise colour codes are as below:-



Specifications with Slogan & Colour Code for Major Work (No.01)

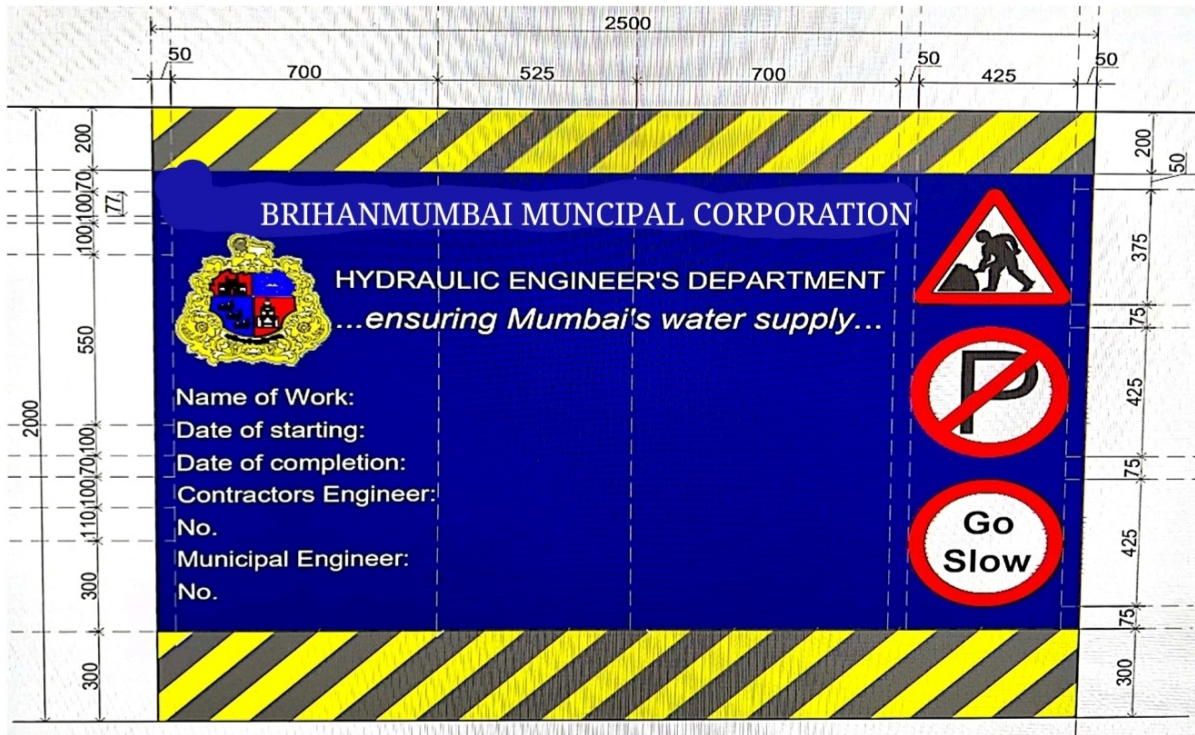

Specifications with Slogan & Colour Code for Major Work (No.02)

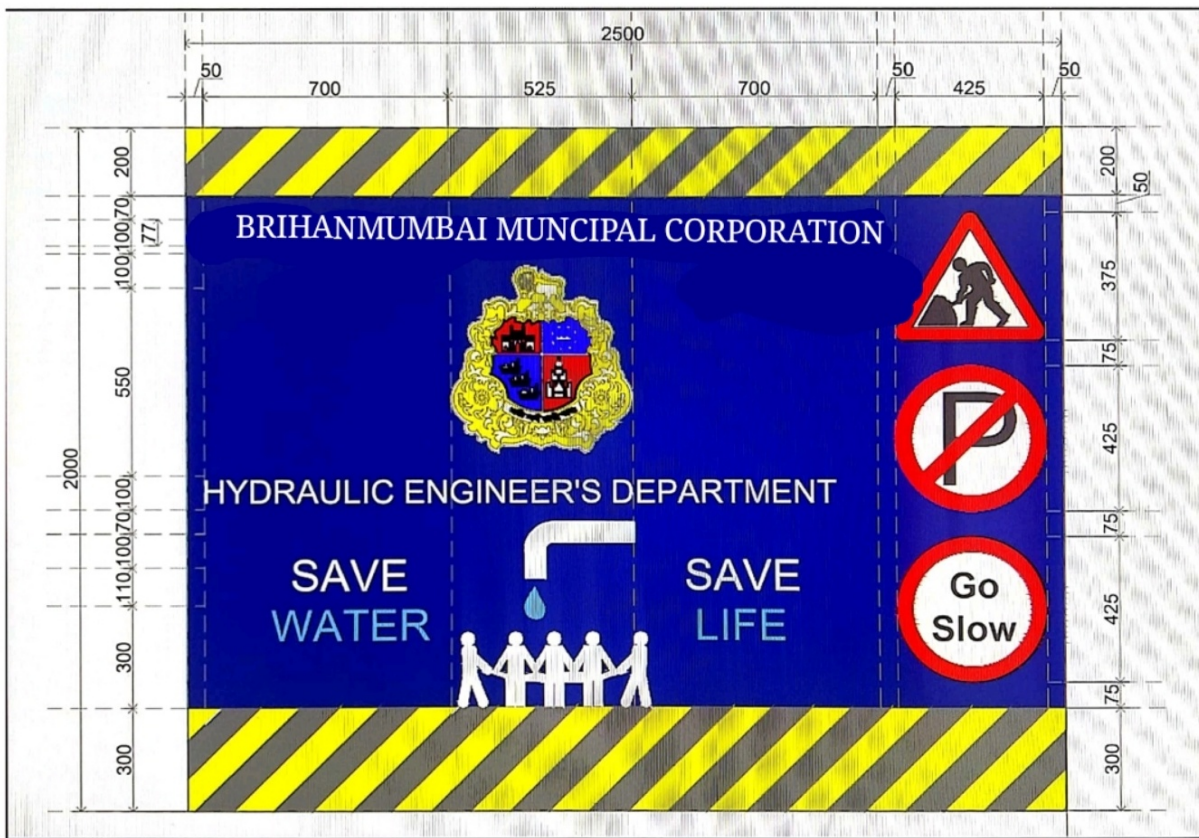

Specifications with Slogan & Colour Code for Major Work (No.03)



Specifications with Slogan & Colour Code for Major Work (No.04)

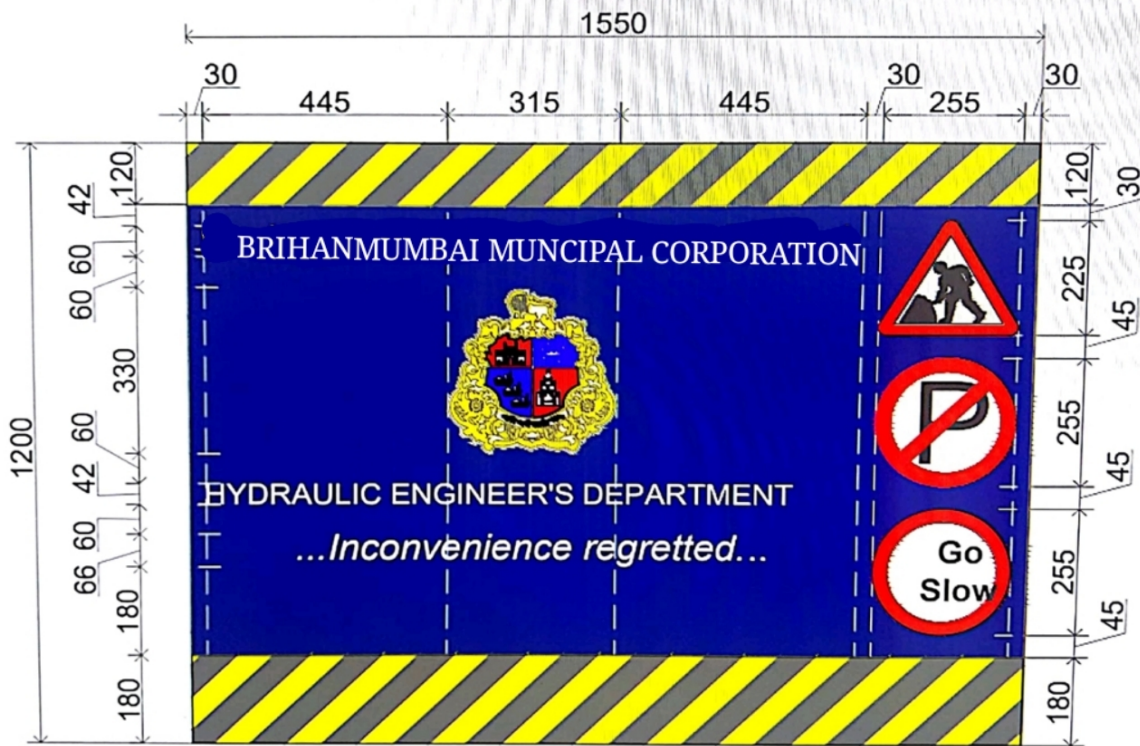

Specifications with Slogan & Colour Code for Minor Work (No.01)

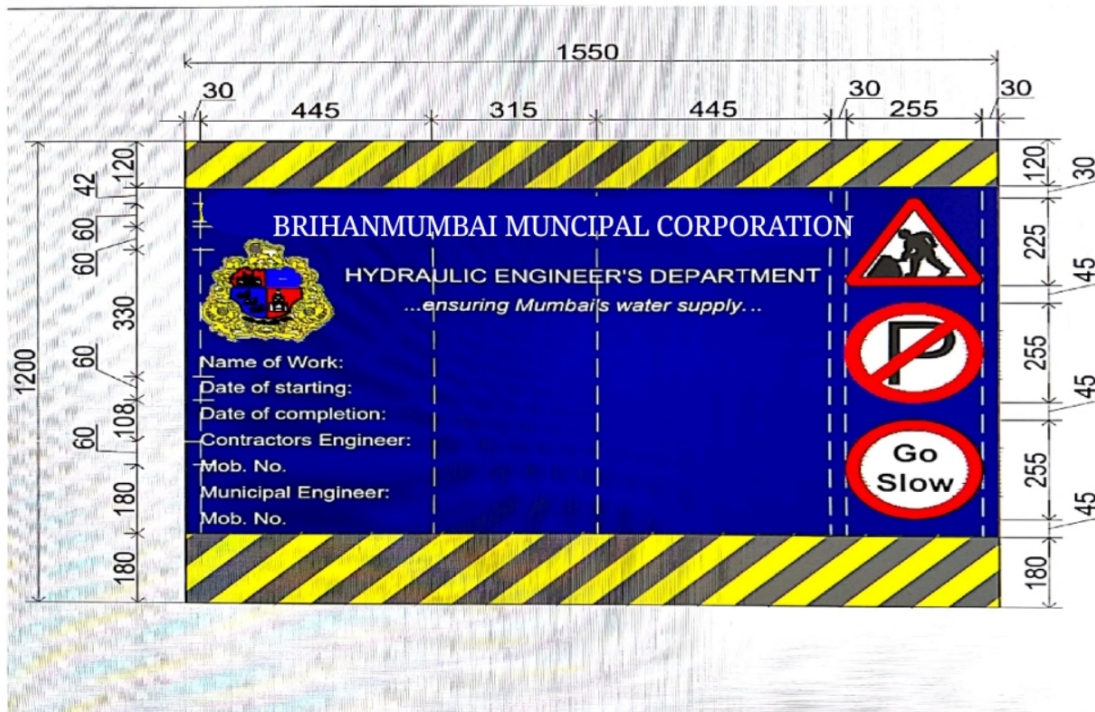

Specifications with Slogan & Colour Code for Minor Work (No.02)

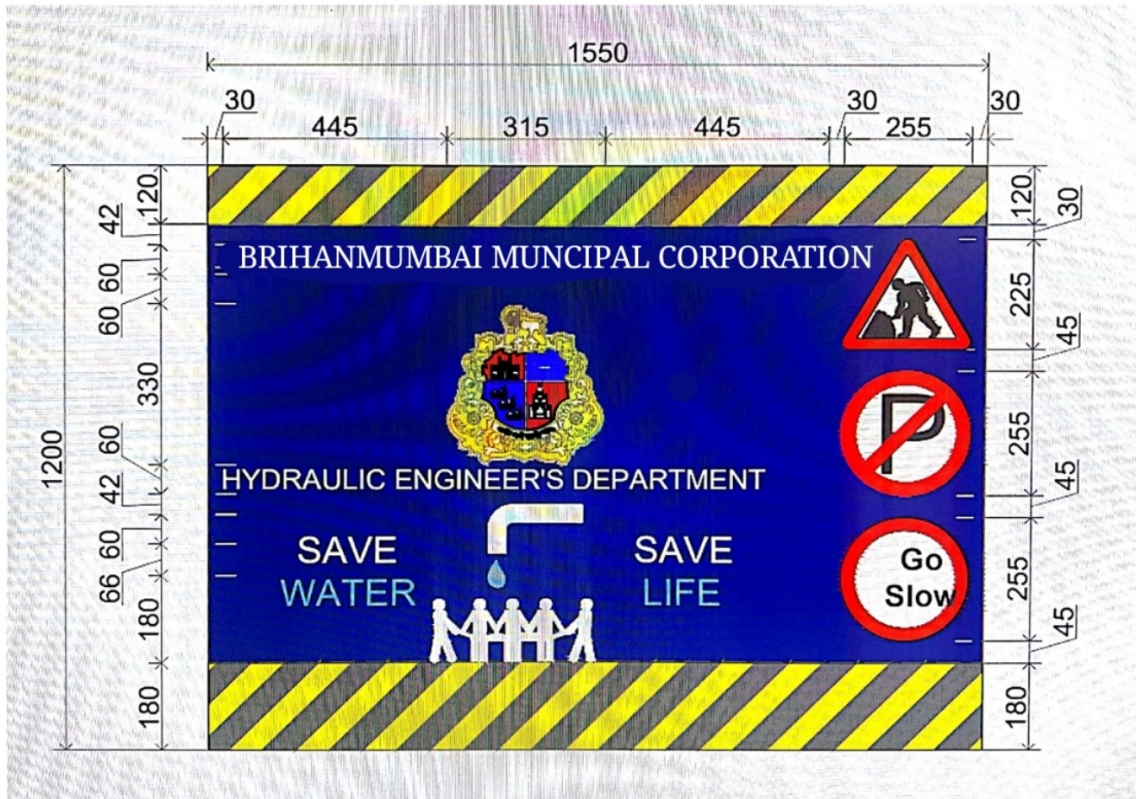

Specifications with Slogan & Colour Code for Minor Work (No.03)

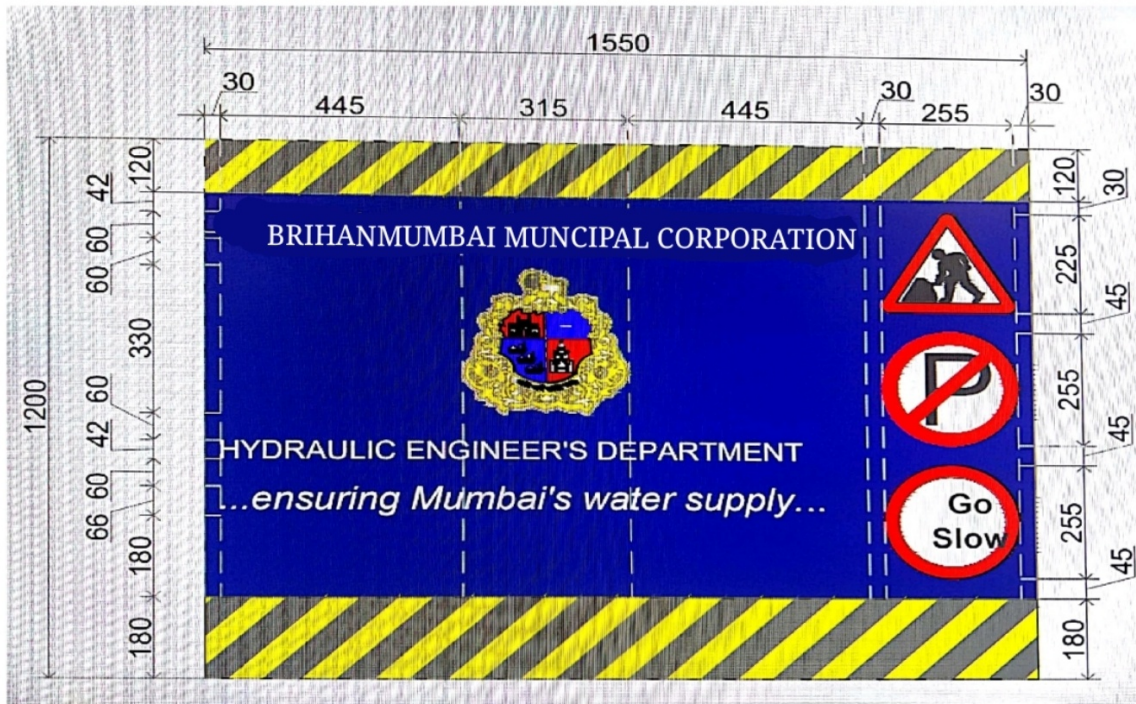

Specifications with Slogan & Colour Code for Minor Work (No.04)



- 6.47** Quantities of all items provided in the BOQ may not be required to be executed depending upon the site conditions. The tenderer shall not be entitled for any compensation on this account. Before starting the work, tenderer shall consult with the site in charge and shall take actual measurements on the site for procurement of material.
- 6.48** The tenderer should note that while executing the jobs allotted to them, the payment will be made as per the items included in the BOQ & as per the relevant items included in the various unified schedules of Rates of the B.M.C effective at the time of work and if any item or activity doesn't cover in the BOQ, the payment will be made as per the G.C.C or as amended from time to time by B.M.C.
- 6.49** The Tenderer shall procure necessary material required for the work with ISI mark wherever applicable from the manufacturer(s), with ISI certificates and or according to B.M.C specifications.
- 6.50** All material required for the work can be stacked near the site of work in such a manner so as not to cause any inconvenience to the pedestrian and vehicular traffic. If no space is available on site then tenderer shall make his own arrangement for stacking of material etc. No extra payment will be made on this account.
- The tenderers shall have to make their own provisions for site office / labourers huts / site godown either on his / her own place or rented / leased place. No permission shall be granted vide circular u/no ChE/487/Rds(Tr&Br)/SR dated 18.09.2012 for erecting site office / labourers huts / site godowns on road carriageway / footpath.
- 6.51** The tenderer shall obtain traffic permission from Traffic Police Department. For erection of site office, cement godown, store etc. wherever required. The tenderer shall obtain necessary permission from concerned competent authority on payment of necessary charges as demanded by the concerned authorities as per the prevailing rules. The cement godown, watchman's cabin etc. shall be provided as directed and shall be removed by the Tenderer on completion of the work at their cost wherever required. It is also binding on Tenderer to fulfill requirements of environmental authorities. The work shall be started only after construction of site office, cement godown, store etc. (after completing all formalities) and after getting necessary traffic. Permission, road opening permission if applicable etc. The work is required to be executed at one / more places and hence the contractor will be directed by the engineer to start the work at more than one place. BAR / C.P.M / P.E.R.T / Milestone chart shall be submitted considering all these factors.

- 6.52** The tenderers should simultaneously work at one / multiple places as directed by Engineer to complete the work within contract period. BAR / C.P.M / P.E.R.T / Milestone chart shall be submitted considering all these factors.
- 6.53** Tenderers shall obtain permission from traffic police department and shall provide various boards and proper barricading of trenches wherever necessary on site to have smooth traffic as per the requirement of traffic police department and shall have proper coordination with competent concerned authority/ward staff, A.E.W.W and A.E.W.W (Maint.) etc. If required & insisted by traffic police department traffic warden shall be appointed on site.
- 6.54** Tenderer shall have to obtain all the permissions of the concerned authorities required for carrying out the work. Only recommendatory letters will be issued by the B.M.C.
- 6.55** Within one month of completion of work, the tenderer shall submit at his cost seven copies of Ammonia prints of completion drawings of laying work if any along with soft copy showing all the details checked and duly signed by Engineer & tenderer. The payment of final bill shall be made to the appointed Contractors after receipt of above sets failing which necessary action as per G.C.C / circulars in force on the date of work order till the entire contract period will be initiated.
- 6.56** Item of cutting C.I. pipe is also applicable for Ductile Iron Pipe and no fair rate will be admissible.
- 6.57** The contractors should provide suitably required number of M.S plates on trenches of suitable thickness and size for smooth movement of vehicular traffic as per the requirement of traffic department. Contractor should note that no payment will be made to the contractor for providing, removing and refixing M.S plates on trench etc.
- 6.58** While excavation of trenches, temporary arrangement like placing of M.S plate over/ trenches in front of the entrances of the properties shall be done to allow vehicles/ public entries to the properties. No extra payment will be made for this.
- 6.59** All mild steel specials required for execution of work shall be fabricated from pipes on site. No extra cost will be paid for fabrication of M.S. specials except payment for welding and cutting under respective item of bill of quantities. Also payment for laying of M.S specials in trenches will be made with average length for bends (mean of internal outer length). In case of valve

chambers, the required M.S cover plates & M.S sections will be considered for payment on weight basis & it is inclusive of cutting, welding, fabrication, etc, required to complete the work.

- 6.60** Contractors should note that the work of laying of water main and work of cross connections shall be done simultaneously within the time period. As soon as laying work is started main cross connection shall be carried out and water main shall be flushed as directed.
- 6.61** **Tenderer should note that the supply of material, supply of C.I. specials, M.S specials if included in the Bill of Quantities shall be made available anywhere in the city or suburbs or at the departmental work chowky as directed. The rates of these supply items include transport, loading, unloading etc. complete. (Note: the suitable rebate will be considered as applicable.)**
- 6.62** Tenderer shall note that H.E's schedule item for Butterfly valve is inclusive of providing and fixing adopter. No extra payment will be made on this account.
- 6.63** The contractor will be directed by the Engineer to execute the additional emergency work of excavation, laying of water mains, cross connections, construction of S.V. Chambers, concrete blocks, digging trial pits & other related works to H.E. Dept. etc. to any extent. The quantum of the work of any item may get reduced or increased to any extent. However, the payment of the work shall be made as per terms and conditions of contract.
- 6.64** Wherever mechanical joints will be used on the water main it will be necessary to fill the gap between the outer edge of the pipe and special / collar/socket with spun yarn as usual. The costs of fixing mechanical joints are inclusive of said work. No extra amount will be paid on this account.
- 6.65** The sluice valves, B.F. valves, air valves, fire hydrants etc. to be provided on proposed water main shall be as per relevant I.S/M.C.G.M specifications and shall be got tested in Municipal Workshop or as directed by the Engineer.
- 6.66** In case the controlled concrete to be provided at one place/or on particular day, is of small quantity i.e. less than 10 Cu.m, M10 may be considered as equivalent to 1:3:6, M15 as 1:2:4, M20 as 1:1.5:3. The concrete sample/ cubes for M10, M15, M20 shall be tested for every 100 Cu.m quantity irrespective of individual quantity is less than 10Cu.m.

- 6.67 The contractors shall bring the correct size of metal/material required for construction of water bound layers. The contractors will not be allowed to break stones for preparation of material for water bound layers on site.
- 6.68 The rate of supplying, loading, transporting on site, unloading and lowering in trenches of all kinds of pipes up to 450 mm dia. is inclusive of cleaning, flushing and testing of water mains up to 10 kg /cm<sup>2</sup> pressure as directed by the engineer.
- 6.69 Latest circulars / guidelines should be followed for providing fencing, barricading & lighting.
- 6.70 Please refer circular No. HE/Cir/13 dated 25.10.05 for specification of M.S, D.I & P.E pipes or amended till date.
- 6.71 All the sluice valves to be provided shall be GLANDLESS VALVE & preferably with clock wise opening. False Key (i.e. Chavi) required to operate Butterfly valve should be provided with vertical pipe rod and handle as directed by the Engineer. No additional payment for the same will be paid to the tenderer.
- 6.72 Materials required for fabrication of M.S. pipes, bends and specials etc. mild steel plates of required size and thickness shall be procured at contractor's cost conforming to IS 2062:2006 (or latest revision)-FE-410. The M.S. pipes shall be fabricated as per IS 3589 (i.e. the fabricated company shall have ISI certificate for fabrication of respective dia. of MS pipes). Spirally welded pipes will not be allowed. Every 10th welding joint of mild steel pipe water main shall be tested in metallurgical laboratory for its strength
- 6.73 ~~The M.S. Pipes of dia. 1200 mm & above shall be manufactured from plates confirming to IS 2062:2006 (or latest revision) FE 410 Cu-WA (Copper bearing quality) with copper content as per product analysis between 0.17 to 0.38 percent~~ & the M.S. Pipes of dia. below 1200 mm shall be manufactured from plates confirming to IS 2062:2006 (or latest revision) FE-410
- 6.74 The tenderer shall note that the payment towards procurement of M.S. plates for fabricating M.S. pipes / specials will be made as per tender item only. **No extra charges / payment** for using M.S. pipes fabricated from Fe 410 Cu-WA (copper bearing quality) with copper content between 0.17% to 0.38 % as per specifications will be entertained / considered on any account
- 6.75 The M.S. Pipes shall be manufactured from plates confirming to IS 2062:2006 (or latest revision)- FE -410. The M.S. pipes shall be fabricated as per IS 3589(i.e. the fabricated company shall have ISI certificate for fabrication of respective dia. of MS pipes). Spirally welded pipes will

not be allowed. Every 10th welding joint of mild steel pipe water main shall be tested in metallurgical laboratory for its strength.

- 6.76** All the pipe material should be procured from reputed manufacturers such as JINDAL SAIL, ESSAR, ISPAT etc. The contractor shall submit the original test certificate from the manufacturer for the grade of the material and yield strength.
- 6.77** All the excavated material belongs to the B.M.C. and therefore shall be the property of BMC. It will be mandatory on the part of tenderer to use this material in the execution of works under contract, if the quality of material available is as per the specification. The tenderer should note that if Municipal Dumping Ground is available then contractor has to dump the surplus excavated material to Municipal Dumping Ground at his own cost as directed by the engineer. In case of non-availability of Municipal dumping ground, the intending tenderer should note that the tenderer has to make his own provision/arrangements of plot in BMC limit or outside BMC limit at his own cost for dumping/disposal of surplus excavated material by obtaining the permission from owner of dumping site and NOC of concerned authority for debris management plant etc. **No payment will be made for removal of earth of any work.**

As and when royalties becomes payable to Government Authority on excavated material as per statutory requirements, the payment shall be made by the tenderer. The tenderer shall pay necessary royalties and submit documentary evidences of such payments to the Engineer for his information and records. The intending tenderer should note that, no transportation and other charges will be paid to the contractors and he has to quote their offering considering all factors.

**As per direction given in the circular under no, Dy. Ch. Eng. / SWM / 3957 / OP /dtd. 28.09.2018 contractor has to dispose of C & D waste generated either by (i) Debris on call Scheme if generation of C & D waste is less than 300 MT for entire project, or (ii) contractor shall transport to designated unloading site approved by BMC SWM department by following due procedure if C & D waste is more than 300 MT for entire project. Attached at pg. no. 277.**

- 6.78** ~~B.M.C staff may visit the factory before and/or during fabrication of M.S pipes as directed. The contractor shall make arrangement for the factory visit at his own cost.~~
- 6.79** The payment for internal cement mortar lining work to water main shall be paid on the basis of diameter specified in the bill of quantities and not for actual diameter of pipe within the tolerance limit. No extra claim for payment towards variation in actual pipe diameter within tolerance limit will be considered/ entertained.

- 6.80 The completion reports for various activities along with its drawing shall be submitted to the B.M.C. immediately after execution of the work.
- 6.81 All the materials required to use for execution of the work to be got tested as directed by the Engineer before use.
- 6.82 Noise level shall be maintained as per circular under no. CE/ PD/ 7788/ I dated 05.11.08.
- 6.83 The tender is proposed exclusively for Dy. H.E (Const) division of Hydraulic Engineer's department.
- 6.84 The contractor has to provide vernier caliper, micro meter and digital instrument for measuring thickness of pipe/ferrule etc.
- 6.85 The tenderer shall note that the tie bars if required to be provided by drilling holes to the existing cement concrete as directed the said work shall be done as directed by the engineer without any extra/additional cost to BMC.
- 6.86 The tenderer shall remove the water, filled for hydraulic testing of the newly laid water main/ water main stretch if required after satisfactory testing at his own cost without claiming any extra /additional cost towards dewatering to BMC.No payment will be made for any kind of dewatering
- 6.87 There is a paucity of space for stacking of pipes. The pipes may have to be delivered and unloaded near the site at locations far away from place of laying the pipes. However, no payment will be made for double handling or transport beyond 500 meters from place of laying. No payment for re-transportation, loading, unloading etc. of pipes or specials received at site for activity beyond 500 meters will be made under any circumstances. The successful bidder will have to manage transportation of pipes and specials etc. to site bearing this constraint in mind.
- 6.88 After completion of work, contractor has to submit detail location of work with three reference point and also of water main laid.
- 6.89 **The contract period is exclusive of monsoon.** Normally excavations are not permitted in the month of May and Tenderer shall complete refilling and reinstatement of all trenches, and the site shall be cleared in all respect including removal of surplus material on or before 15th May of every year or as directed by Engineer. During the monsoon period, i.e. from closure of excavation if any urgent work is directed, then actual working period of that working period of that work will be considered as working days.

- 6.90** Tenderer at his cost, (i.e. including cost of testing, transportation, loading, unloading of material etc complete) shall test pipes, specials, valves, cement and all other material, as directed by the Engineer. No extra payment will be made on this Account.
- 6.91** Surplus Excavated earth / concrete material / Asphalt cakes / debris on site shall be removed speedily from the site by the contractor as directed by Engineer in charge.
- 6.92** The tenderer shall arrange for and test water main at required pressure as directed at his cost, failing which, same will be carried out by the B.M.C at the risk and cost of the tenderer. After testing of water main, same shall be handed over to competent authority of B.M.C. / A.E.W.W of respective wards / A.E.W.W (Maint) by the tenderer as directed.
- 6.93** The rate of supply, loading transporting on site, unloading & lowering in trenches of all kinds of pipes up to 450mm dia. is inclusive of cleaning, flushing & testing of W.M up to required pressure as directed by the Engineer.
- 6.94** If a part of completed line is required for commissioning, the same shall be handed over to the Corporation after specified testing of water main by tenderer at his cost. No extra payment, for carrying the material by head load to work site, shall be considered under any circumstances.
- 6.95** ~~The tenderer(s) shall note that only 95% payment of payable amount will be released for the completed work and balance 5% shall be released after completing the following works:~~
- ~~a) Testing of pipeline along with fittings satisfactorily.~~
  - ~~b) Reinstatement of trenches.~~
  - ~~e) Returning of reclaimed materials to the Municipal Store / Ward as specified.~~
  - ~~d) Cleaning the site.~~
- 6.96** No core cut sample will be allowed in case of asphalt mix.
- 6.97** Tenderer, at their cost shall submit seven sets of “As laid” drawings of water main showing actual alignment with three-point location along with the soft copy within 30 days upon submission of final bill.
- 6.98** ~~The work may be subjected to third party audit for quality assurance. The representative of the quality assurance agency appointed for third party audit will supervise the work on day to day basis or as directed by Engineer. Tenderer should make necessary sitting arrangement for representative of this agency. The quality assurance agency will issue instructions through the site in charge of B.M.C. during execution of the work. All the observations, instructions made by the quality assurance agency & confirmed by B.M.C. staff will be binding on the contractor & they should be complied accordingly by the contractor.~~

- 6.99** Program of work: If at any stage the previously approved program is required to be modified, the tenderer shall do so immediately as directed by the Engineer. If it is necessary to close some phase of the work and start a new phase as directed, the tenderer shall do so without claiming any extra payment. The program shall be reviewed periodically and rescheduled as directed.
- 6.100** Measurement of excavation shall be as per the items in the Bill of Quantities. If the actual excavations are more than the specified, excess excavation shall not be payable. However, if the actual excavations are less than the specified but accepted by the Engineer, the same shall be paid at actual.
- 6.101** The cross connection works etc. are required to be planned in view of the water supply hours in a particular area. Extra payment shall not be considered for works carried out during early, late or night hours. The work of cross connection at the tapping point shall be undertaken immediately after starting the work. Subsequently the work of cross connection at down streamside shall be completed. In any case the cross-connection works shall be completed within one month of start of laying of pipes. If tenderer fail to carry out the work within the non-supply hours, the same will be carried out by the B.M.C at the risk and cost of the tenderer and recoveries shall be effected from the dues payable to the tenderer.
- 6.102** The contractors will have to work during night time also and no extra claims will be entertained. The bidder shall note while working during night hours the machineries used shall comply with the noise levels as mentioned in circular No CE/PD/7788/I/dated 05.11.2008.
- 6.103** ~~There is a paucity of space for stacking of pipes. The pipes may have to be delivered and unloaded near the site at locations far away from place of laying the pipes. However no payment will be made for double handling or transport beyond 500 meters from place of laying.~~
- 6.104** ~~No payment for re-transportation, loading, unloading etc. of pipes or specials received at site for activity beyond 500 meters will be made under any circumstances. The successful bidder will have to manage transportation of pipes and specials etc. to site bearing this constraint in mind.~~
- 6.105** As regards payment for providing & fabricating M.S pipes, no payment will be made to contractor against the supply of M.S pipes. The payment for supply of M.S Pipes shall be made only after completing laying& welding work of M.S pipes. **However, supply of M.S fabricated pipes shall be in proportionate to the planned work of pipe laying as shown in the Bar Chart / C.P.M /P.E.R.T. Supply of M.S pipe beyond the quantity mentioned in the Bar Chart / C.P.M /P.E.R.T will not be entertained for payment towards the supply. However, if the work is ahead of the schedule the payment will be made accordingly. The Bidder / Contractor**



**should note this specifically. The tenderer should note this specifically while submitting the bids & plan the work accordingly.**

**6.106** No extra payment will be made for cofferdam, dewatering of any source of water including dewatering of body water from water mains, barricading, removal of silt, removing of earth etc.

**6.107** Details of recovery of existing sluice valve replaced by the contractors in the tender work are:

- a) For 150mm dia. S.V., recovery will be made at the rate of Rs. 2481.56 per number.
- b) For 250mm dia. S.V., recovery will be made at the rate of Rs. 6221.38 per number.
- c) For 300mm dia. S.V., recovery will be made at the rate of Rs. 8388.38 per number.

**6.108** ~~Item of SOR 2013, CS MW 1 b Brick work with common burnt clay F.P.S. (non modular) bricks of class designation 7.5 in foundation and plinth in: Cement mortar 1:4 (1 cement : 4 coarse sand) is included in this tender. However, many of the times common burnt clay F.P.S. (non modular) bricks of class designation 7.5 as specified in schedule of rate are not available in market and due to the emergency of the work of construction of sluice valve chamber, the same work is carried out using regular brick (for example K.B.K. Bricks) in such cases rebate of rupees 1100/- per Cu.m will be taken towards use of regular brick.~~

**6.109 Site Office & its allied conditions:**

On the receipt of the work order, the contractors will have to erect ready-made AC site chowky at least one number or more as directed by the Engineer in form of Porta cabin/ Container cabin or semi permanent or permanent structure with appropriate insulation from heat, and one or more Godown, before commencement of the work, without any extra cost. The contractors will obtain necessary permission from concerned Asstt. Commissioner of ward/s or competent B.M.C authority for suitable location for the site office/chowky, godown, place for stacking machineries & material etc. The contractors will provide following facilities, equipments, chowky, etc

- i.* Successful tenderer, therefore, will have to furnish information as regards the name and complete address of his bank, its branch and the bank A/C No, and Vendor Regn. form etc. along with tender document. They will have also to submit fresh information when there is any change in this regard.
- ii.* The Porta cabin of area preferably about 30 sq.m. with air conditioner with at least two windows for proper ventilation.
- iii.* It should have toilet facility with necessary plumbing arrangements. After completion of the work, the chowky and toilet should be completely removed within 7 days.
- iv.* The Chowky should be equipped with electric supply, fans, sufficiently big tables, chairs, cupboard with locking arrangement and water filter (of approved brands) etc.

- v. The successful tenderer will have to make his own arrangement at his cost for the electric power supply required for the work either by taking connection from M.T.N.L / RELIANCE/M.S.E.B/B.E.S.T/TATA or arrange his own generators.
- vi. Tenderer, at their cost shall provide and maintain a telephone at the Engineer's site office.
- vii. The contractors are directed to make suitable arrangement in site office to prepare and maintain site record/registers so as to enable to upload the same in SAP.
- viii. The site staff of execution department shall invariably prepare and certify and maintain records during execution of the work for all the P.O. items of the works executed on the site before processing of bills and the record must be produced as and when required by higher authority.
- ix. Contractor shall provide 10 megapixel digital camera for taking photographs of work during execution & also later, if required.
- x. Site godown & separate cabin/Site Laboratory adjacent to site office for contractor's staff / any other consultant / Quality control auditors if appointed by B.M.C as per requirement.
- xi. The contractors will be given 12 mm dia. or 20 mm dia. (or as decided by the H.E) metered water connection for drinking purpose only if necessary. Extra water required for construction purposes will have to be brought by the contractors at his cost and no extra claims on this behalf will be entertained. The contractors have to obtain necessary permission for such connections from respective A.E.W.W of wards /Competent Authority and shall pay the necessary connection charges.

**Note: A)**

***i) If chowky / Site office with necessary requirements is not provided within 30 days from the date of issue of work order, a penalty of Rs 10000/- per day will be imposed.***

***ii) If there is further delay more than 30 days, a penalty of Rs 20000/- per day (i.e. starting from 31st day from the date of issue of work order) will be forfeited from paid A.S.D, OR will be recovered from 1st R.A. Bill.***

***iii) If there is further delay more than 45 days, a penalty of Rs 50000/- per day (i.e. starting from 46 the day from the date of issue of work order) will be forfeited from paid A.S.D, OR will be recovered from 1st R.A. Bill.***

***B) If any of the items except at A of the notes mentioned above is not provided, Additional penalty of Rs. 1000/- per day/item, will be imposed.***

The bidders have to consider the costs of all items mentioned above and quote their % accordingly.

**6.110 ~~Vehicles/Transportation arrangement for Engineers and Employers Staff:~~** ~~The subject work may need to be carried out at various junctions/locations at the same time. Due to this the contractor has to make transportation arrangement for engineers & his staff round the clock 24 x7 till completion of work for smooth working & supervision of the subject work. The transportation arrangement shall be provided from the date of starting of the work. No payment will be made for the same.~~

**6.111 SITE LABORATORY: (Required/ Not required)**

(Space for site laboratory will not be provided by B.M.C.)

Contractors shall set or provide a laboratory at or around the site of size about 30 sq.m before commencement of work at their cost for performing various tests and at least the following machines and equipments shall be provided therein:

- 1) Roadometers, Torches, measuring tapes of lengths @ 3 R.m, 15 R.m, 30 R.m, & 50 R.m of approved make.
- 2) Kadappah stone platform of size 2.5 R.m x 0.9 R.m approx.
- 3) First Aid box.
- 4) Compressive testing machine (for concrete cube tests), of minimum 150 tonne capacity electrically operated and duly calibrated every 6 months. Testing machine should be maintained properly. In case of failure, the same shall be repaired or replaced within 2 days.
- 5) Set of sieves.
- 6) Sieve Shaker.
- 7) Laboratory weighing balance of minimum 20 Kg capacity, with set of standard weights, from 1gm. to 5kg. & Electronic weigh balance with least count of 1 gm. with electric operated.
- 8) Aggregate drying equipments M.S Tray of 0.6 M x 0.45 M and kerosene stove or electric hot plate.
- 9) Equipment for testing of silt content in sand.
- 10) 12 Nos of cube moulds.
- 11) Slump cone.
- 12) Infra Red thermometer calibrated upto 250 degree Celsius (for checking asphalt/bitumen temperature).
- 13) Camber Board
- 14) Electronic thermometer calibrated at least upto 300 degree Celsius and glass thermometer calibrated upto 200 degree Celsius.
- 15) Field density bottle along with cutting tray, chisel, hammer and standard sand.
- 16) Bitumen Extraction machine / Bitumen core cutting machine.
- 17) Curing tank with adequate capacities.
- 18) Density gauge to check the field density of bituminous & sub base layers & soil strata.
- 19) Flakiness and elongation index Gauges.
- 20) 3m straight edge.
- 21) Any other machines / equipments as may be directed by the Engineer.

The laboratory shall be established *within 30 days from the date of work order*. On failure to do

so, a *penalty of Rs 5000/- per day* shall be imposed. All materials used prior to establishment of lab are to be tested in B.M.C. Material Testing laboratory (M.T.L) / other B.M.C. approved labs.

*All the test records shall be maintained in the site office & made available as & when required. The Engineer of the Contractor will conduct field density test periodically under the supervision of B.M.C. staff/any other consultant if appointed by B.M.C. & maintain the relevant in records.*

#### **6.112 Instruments to be provided:**

The Contractor shall provide at his own cost for the exclusive use of the staff of the Engineer all survey equipment's & measuring instruments of approved make & of every kind necessary for execution of the work as and when directed by the Engineer, including:

- a) Automatic Surveyor's level (01No) with horizontal 360 degrees circle, tripod with carrying case, all to the approval of The Engineers representative. The instrument shall be calibrated as & when instructed by the Engineers representative. The same shall be kept available at all times at the site chowky.
- b) Two (2) Levelling staff 4.5 m long each in 3 sections & with attached bubbles graduated in meters & Tenths & Hundredth of a meter all to the approval of the Engineer.
- c) 12 Nos of cube moulds and Curing tank with adequate capacities
- d) Two (2) Surveyors Steel Bands of which one shall be 100 Mt. long & approximately 20 mm Wide & 1 shall be at least 30 Mt. long & 12 mm wide each fully divided.
- e) Two (2) thermometers for taking temperatures of Asphalt mixes.
- f) Any other instruments required for work as directed by Engineer.  
Roadometers, Torches, measuring tapes of lengths @ 3 R.m, 15 R.m, 30 R.m, & 50 R.m of approved make.
- g) First Aid box

#### **6.113 Testing of Materials:**

All requests for testing of samples must be made in writing in duplicate, specifying therein the following information (separate memo should be sent for cement, concrete, steel, soil, asphalt etc.). This includes testing suggested by third party quality assurance agency through the site in-charge at tenderer's cost in Govt. approved laboratories.

- a) Name of the Work, Work Code No. if any.
- b) Type of material and tests desired (i.e. grade of cement, date of Consignment).
- c) Identification mark on the sample should be mentioned on the forwarding memo (in Case of concrete beams and cubes identification marks, grade of concrete, date of casting, specimen No. should be engraved on concrete. If these details are marked by paint, samples will not be accepted. In case of re-

inforcement bars, details shall be displayed on label pasted on bars and label must be signed by the officer, who has taken the samples).

- a) Name and full postal address of the officer to whom the results must be sent.
  - b) Date of sampling (i.e. date of laying asphalt mix, Sr. No. of load casting concrete or taking cement samples).
  - c) Name of the contractor carrying out the work.
  - d) Any other information which is specified by the user department.
1. Samples must also bear the identification mark and signature of site in-charge taking the sample. In case of samples of asphalt mixes sent in polythene bags a legible duplicate tag should be stapled from outside.
  2. Quantity of sample must be adequate as shown in the schedule, available with H.E.'s office.
  3. Full testing fees as per schedule in force shall be paid in advance between 10.30 a.m and 1.00 p.m. on working days except Saturday, and between 10.30 a.m. and 12.00 noon on Saturday. These fees shall be borne by the tenderer(s).
  4. For issuing additional copies or duplicate copies Rs20/- or fees as prevailing rates will be charge for each copy. Request for additional/duplicate copy may be made in writing by site in charge or higher officers of the user department.
  5. Cement sample should be forwarded in sealed airtight container with one lid on top not less than 10 cm. in diameter.
  6. Moulds of concrete cubes/beams taken on hire shall be returned in clean, oiled condition with all nuts and accessories in proper position.
  7. Sample for tensile testing of reinforcing bars shall be straight for entire length without bends. The ends of the bars shall be hacksaw cut and not chisel cut. One sample of each diameter bar shall be sent for first test and for retest two bars shall be sent. The length of the bars shall be 50 cm. for diameter upto 25 mm and 60 cm for dia equal to and greater than 25 mm.
  8. Samples of bitumen, cut back, emulsions shall be forwarded in wide mouthed metal containers with label pasted on the lid.
  9. Samples that are sent for testing natural moisture content shall be forwarded in wax coated packing or sealed airtight polythene bags.
  10. Undisturbed samples sent in sampling tube shall be wax coated on both Open ends.

11. **Penalty:** The tenderers shall arrange to deliver A.M sample for testing to Municipal Testing Laboratory within 4 (four) days from the date of laying of asphalt mix on site. In case of delay, additional testing charges as penalty would be recovered from the contractor at following rates.

*A) From 5<sup>th</sup> day to 7<sup>th</sup> day: Rs10000 / - per sample from date of laying  
asphalt mix on site.*

*B) From 8<sup>th</sup> day to 14<sup>th</sup> day: Rs 20000 / - per sample from date of laying  
asphalt mix on site.*

The above charges i.e. A & B shall be paid by the contractors at the time of submitting samples in Municipal Testing Laboratory. If the samples of A.M are not sent for testing within 14 days payment for the corresponding quantity of those samples shall not be made.

**6.114 SPECIAL DIRECTIONS TO e-TENDERERS:**

1. The subject work is underground & unforeseen, unplanned, unidentified nature may need to be carried out at various locations at the same time & also at adverse site conditions. The work is required to be carried within the restricted width and movement of very vehicular traffic is also required to be allowed abutting to the excavated trench. The contractor shall take utmost care/ necessary precautions/ preventive measures while carrying out the work so that vehicular traffic/pedestrians traffic shall ply safely and smoothly during the execution of work to avoid any mishap. If any mishap is happened during the execution of work the consequences of the same inclusive of legal and financial will be entirely contractor's liability and same shall be taken into account while bidding for the tender.
2. The subsoil strata may be silty/marine clay or silty clay with gravel and sand rocky strata is also likely to be encountered at some stretches of water main laying works.
3. The tenderer shall take suitable measures to protect the sides of the excavated trench at his own cost till water main laying work including allied works are completed and trench is finally reinstated.
4. The tenderer shall note that the work of laying of various dia. D.I.W.M., Cross-Connections & its allied works are to be started simultaneously at multiple locations in respective ward as directed.
5. The reinstatement of each stretch has to be started and completed immediately once the water main is hydraulically tested. If reinstatement is required to be carried out before hydraulic testing for any reasons whatsoever, the same will be allowed on submission of undertaking by the bidder regarding satisfactory hydraulic testing of the laid water main. In case of failure in hydraulic testing of the laid water main, the same will have to be rectified by the bidder including reinstatement at his own risk & cost.

6. Tenderer shall note that if the reinstatement work is delayed the tenderer has to take necessary steps to bring the excavated trench portion of the particular stretch in motor able and safe conditions at his cost and no extra payment for the above-mentioned works will be entertained & appropriate penalty will also be imposed.
7. As per circular issued by Hydraulic Engineer U/No. HE/336/SR dated 29.04.2024, it is mandatory to use Diamond cutter for cutting of existing CC Road pavement. Tenderer shall note that cutting of existing cement concrete road pavement by using diamond saw machine will be paid as per tender item no. **HE-8-27-a** only. Diamond core cutter with the depth of 30 / 35 cm shall be used for uniform cutting of existing C.C pavements by the tenderer so as to avoid damage to the pavements adjacent to cutting area. If the adjacent cement concrete pavement is damaged by the contractor, the same shall be get rectified by the tenderer as directed at his own cost. No separate charges towards supplying water & electricity for the said work will be entertained / considered on any account.
8. If required, the successful tenderer has to carryout sub soil investigation and total station survey before/during the subject work and should submit the report to BMC. The tenderer should note that no any payment will be made for sub soil investigation test and total station survey.
9. **In case of non-satisfactory / failed results of 28 days concrete compressive strength, if 28 days concrete cube compressive strength test sample strength at MTL/NABL accredited labs are not satisfactorily/failed; in such circumstances re-assessment of strength of concrete shall invariably to be done only at Municipal Testing Laboratory(MTL) by joint witness by the officer not below the rank of Assistant Engineer of the project and the representative of the contractor for assurance and acceptance of the strength of concrete work.**

**6.115 SPECIAL CONDITIONS OF CONTRACT**

1. The work is required to be executed at one / multiple locations or as directed by Engineer-in-charge. The contractors will have to obtain permission accordingly from the Traffic Police department/Railway Authority /BMC ward office well in advance either for closing down the road partially/fully or for diversion of traffic for execution of the work, the contractors should therefore consider this factor while quoting.
2. The contractor shall have to obtain all the permissions of the concerned authorities of B.M.C. / other than B.M.C required for carrying out the work. Only recommendatory letters will be issued by B.M.C.
3. Quantities of all items provided in the B.O.Q. may not be required to be executed depending upon the site conditions. For procurement of materials before starting the work, contractor shall take actual

measurements on the site as per tendered work, contract period & get himself acquainted with existing site conditions. The tenderer shall not be entitled for any compensation on this account such as excess procurement of pipes, valves...etc

4. The contractor shall procure all material required for the work from manufacturers with I.S.I certificates and according to B.M.C specifications/approved list wherever applicable.
5. Corporation may appoint a consultant for quality audit, during execution period. The contractor will extend all help in carrying out any survey; test etc. as directed and adverse decision there of including rectification shall be carried out by the contractors at their cost.
6. All material required for the work can be stacked near the site of work in such manner so as not to cause any inconvenience to the pedestrian and vehicular traffic. If no space is available on site then tenderer shall make his own arrangement for stacking of material etc. No extra payment will be made on this account.
7. The contractor should note that during the execution of the work the excavated material will have to be removed immediately after completion of the work as per direction of the Engineer, failing which the same will be got removed at their risk and cost. The site shall be cleared by removal of surplus material within 24 hours after refilling the excavated trench.
8. The Contractor should note that Running Bill/ Final Bill of project works shall be accompanied with GIS Mapping Certificate as per Circular no. CA (F)/EXP/FI/22 dated 30.09.2019. **(Pg.264)** If any Running Bill / Final Bills not accompanied with GIS Mapping Certificate, the same will not be accepted for payment. Also, GIS Mapping conditions under no. EE/WDIP/SR/51/DT. 15.06.2023 & EE/WDIP/SR/53/DT. 22.06.2023 **(Pg.277-280)** is applicable for this tender.
9. Tenderer shall note that in respect of the Grievance Redressal Committee (GRC) policy circular u/n DY.ChE/CPD/2025 dt. 01.09.2021 and Ch.E(Vig)/436/B dt. 18.05.2023 shall be applicable.**(Pg.274-276)**
10. **The tenderer shall note that work of laying water main and road improvement work under taken by road is in progress simultaneously then item included in BOQ in respect of reinstatement work will not be operated and no claim regarding the non-execution of said item shall be entertained. Bidder shall take this aspect in consideration and put their offer accordingly.**



**6.116 Concrete Works:**

1. All concrete works shall be carried out by Ready Mix Concrete / unless otherwise specified in respective items.
2. Testing for compressive strength of concrete works shall be carried out as per the Quality Assurance Manual, or as directed by engineer in-charge. Twelve cubes (150 mm x 150 mm x 150 mm) shall be cast & tested for compressive strength for 7, 14 & 28 days at the site laboratory. For concrete of grade M 35 or higher, corresponding three flexural beams (700 mm x 150 mm x 150 mm) for flexural strength of 28 days shall also be cast & tested, for every day's work at the laboratory attached to the R.M.C. plant. In case of failure in compressive strength for 28 days, the remaining three cubes shall be sent to the municipal laboratory or any other laboratory approved by Ch.E (Rds & Tr.), as directed by engineer in-charge for re-testing.
3. Besides, once in a month, compressive strength for 7, 14 & 28 days & flexural strength for 28 days (for concrete of grade M 35 or higher) shall be carried out at municipal laboratory or approved laboratory as directed by engineer in-charge.
4. The temperature of Pavement Quality concrete shall be maintained as per IRC: 15:2002. Concrete having temperature at the time of pouring more than 30°C will not be allowed.
5. The tenderer should note that channels (form work) of specific sizes (150mm, 280 mm or 300 mm or 350 mm) may have to be manufactured as per the design of concrete pavement slab for which no extra payment will be made and tenderer has to quote his % rate accordingly.
6. The contractors shall make necessary arrangement for adequate lighting during night-time & as per the conditions insisted by Traffic police department N.O.C for the work. No extra claims will be entertained for the same.
7. List of approved Paver block manufacturers/ Asphalt Plants/ R.M.C. Plants etc. have been incorporated in this document. However, B.M.C. reserves right to modify these lists. (The updated list of approved paver blocks manufacturers at “the time of execution of works” shall be obtained from the Dy. Chief Engineer (Roads) City / E.S’s office.
8. All the asphalt works required to be done under the captioned contract shall be got executed with the specified asphalt mixes manufactured in B.M.C. approved asphalt plants only.
9. All the Paver blocks/ Kerb stones/ Water tables/ Frame & covers required for the works to be carried out under the captioned contract shall be procured from the specified manufacturers registered with B.M.C. only and also the interlocking paver blocks shall have BIS registration.

10. The RMC works required to be done under the captioned contract shall be got executed with pre-qualified / approved RMC plant by B.M.C.

**6.117 Traffic Management:**

1. The contractor shall have to provide adequate number of wardens as per requirement of Traffic Police Deptt. at the contractor's cost.
2. Traffic signs – Temporary traffic and construction signs are to be provided during construction and maintenance operations for traffic diversion and pedestrian safety as per Traffic Diversion Plan.
3. The contractor shall display the boards stating information of the name of the work, date of starting, date of completion, name of the Deptt. and contact telephone no's of Contractor's Engineer.
4. While constructing/improving footpath, provision for sloping ramp of at least 1m width or as directed, shall be made at every carriage entrance, junctions, bus stops etc., for convenience of physically challenged persons.
5. The full time services of the Personnel Team of the contractor is mandatory during the entire period of the project.
6. Diameter of the S.W.D pipe & sizes of manholes provided in the bill of quantities of the tenders are tentative & are likely to change at the time of execution according to the site conditions. Contractor's shall have to carry out such extra items in S.W.D works as per S.W.D schedule rates of B.M.C prevailing at the time of execution of work or as per G.C.C adjusted by rebate/ premium quoted by the contractors and no fair rate will be admissible for the same.
7. The photographs of work sites & works as and when directed by Engineer are to be taken. A new Digital Camera of Min 10 Mega Pixels shall be provided in the site office for the said purpose. The Photographs should be arranged in the Album/ Register showing the relevant activities executed on site. The register should be duly signed by site-in-charge and contractor fortnightly. All photographs may require to be uploaded as & when directed to do so.

**6.118 Price Variation:**

Please refer “price variation” clause no. 79 & 80 of Section 9 GCC.

- a) ~~As the time period of the project is **12 months (excluding monsoon)**, hence any variation in the rates of labour and materials shall not be considered for reimbursement to the contractor. The bidder shall note this aspect and submit their bid accordingly.~~
- b) The bidder shall note that as the time period of project is **24 months (Excluding Monsoon)**, hence the cost contingencies/ price variation for labour & materials shall be considered and will be paid as per indices issued by competent authority considering the relevant clauses of G.C.C. in force & amendments thereof by the BMC from time to time. However, maximum limit for reimbursement is **10 % of the contract cost** including extra items/excess quantities but excluding water/ sewerage and supervision charges & physical and cost contingencies. The bidder shall note this aspect and submit their bid accordingly.

**6.119** Every running bill submitted by the contractor for payment shall be with the detailed measurements recorded for each item.

**6.120** Contract Labour (Abolition and Regulation) Act 1970: The Tenderer(s) should specifically note that the successful tenderer shall have to strictly comply with all the statutory requirement under the provision of the Contract Labor (Abolition and Regulation) Act 1970 and with the Maharashtra State Contract Labor (Abolition and Regulation) Rules 1970 and indemnify the Corporation against any claim(s) whatsoever.

**6.121 Royalty Payment on excavated material as per statutory requirement:**

The contractor shall pay necessary royalties as and when royalties becomes payable to the government authority on excavated material as per statutory requirements. The payment towards royalty charges shall be made by the contractor& it will not be reimbursed by B.M.C. The evidences of such payment shall be submitted for record purpose.

**6.122** If the contractor carries out excavation for any tender / additional work allotted & fails to reinstate the same within the stipulated time limit, as per the program and or before 15<sup>th</sup> of May OR any other date specified by the B.M.C authority, the reinstatement will be got carried out at contractor’s risk and cost through other agency in addition to further penal action.

**6.123** The noise level shall be maintained within the permissible limit in Silence zone area during the construction activities by the Contractors, as per the notification dated 14.2.2000, issued by the Ministry of Environment & Forests.

**6.124** The contractor shall maintain copy of the following registers as applicable during execution of work and it is mandatory to provide Laptops / Desktops to the Site Engineers for the same. The List of Registers / Records / Files etc to be maintained is as under:

<b>Sr.No</b>	<b>Name of Register / Records / Files</b>
01	Daily Progress Register
02	Excavation Register ( Soil, C.C, Road carriageways, Rock ... etc )
03	Correspondence File
04	External & Internal utility remarks File
05	Permission File (Ward / Traffic / Chowky / C.C.Road ... etc)
06	Permission File (Other utility letters viz S.P, S.W.D, S.O, B.E.ST, TATA, M.G.L, M.T.N.L, Railway, Mb.P.T, M.S.R.D.C, M.M.R.D.A ... etc)
07	O/C File
08	Drawing File
09	Instruction Book / Register
10	Level Book if required
11	Mix Design Approval File if required
12	Test Report File (Cement, Sand, Brick, Metal No 1, Metal No 2, Metal No 3, Rock ... etc)
13	Test Report File (Sluice Valve (S.V), Butterfly Valve (B.F.V), Air Valve ... etc)
14	Test Report File (Paver block, G.S.B, W.M.M, D.L.C, M40 RMC ... etc)
15	Test Report File (Asphalt Macadam, Asphalt Concrete ... etc)
16	Test Report File (Pipes, Welding ... etc)
17	Pipe Laying Register
18	Form Work / Shuttering Register if required
19	Encasement Register if required
20	Cement Variation Register if required
21	Cement Register
22	Sub base & W.B.M Register if required
23	Asphalt Macadam, Asphalt Concrete Qty Register if required
24	Asphalt Macadam / Concrete Challan File if required
25	G.S.B, W.M.M Register if required

26	<i>D.L.C Register if required</i>
27	<i>Duct Pipe / Lateral Register if required</i>
28	<i>Steel Register if required</i>
29	<i>M10, M15, M20 C.C Qty, Cube, Variation Registers</i>
30	<i>M10, M15, M20, M35 / M40 RMC Qty, Cube, Variation Registers</i>
31	<i>R.M.C. Challan File if required</i>
32	<i>Pour Card Register if required</i>
33	<i>Joint Cutting Register if required</i>
34	<i>Precast Item Register (Paver blocks, Kerb stone, Dividers etc) if required</i>
35	<i>Precast Item Challan Register if required</i>
36	<i>R.T.I. Correspondence File if required</i>
37	<i>Vigilance Reply File</i>
38	<i>Railway Correspondence File if required</i>
39	<i>Isolation Memo File</i>
40	<i>Hydraulic Testing File</i>
41	<i>Handing Over File</i>
42	<i>Photograph File / Album / Register</i>
43	<i>Penalty Register</i>
45	<i>Sand Metal Register if required</i>
46	<i>M8 Register if required</i>
47	<i>Any other registers required as per description of items for any activity / material / quantity for which payment is made or as instructed by B.M.C staff.</i>

**6.125 IMPORTANT POINTS TO BE NOTED BY THE TENDERER:**

1. The successful tenderer/ Contractor have to co-ordinate between the third party quality assurance agency, if any, and the B.M.C. staff for the quality execution of work.
2. All materials required to be used for execution of the job shall be got tested as directed by third party quality auditor, if any, through the site in-charge before use.
3. The contractor shall prepare all the relevant site records/registers & duly update the same in consultation with the site in-charge. Also, Contractor has to submit the scanned copy of all site records/relevant documents.
4. The jobs allotted to the contractor for execution is to be executed to the satisfaction of the third-party quality assurance agency if any and the B.M.C. The contractor to note this point and plan the execution of work carefully.

5. The completion reports for various activities along with its drawing are required to be submitted to the BMC immediately after execution of the job.
6. It is suggested to the contractor that the contractor may make necessary arrangement for testing of the water main.
7. The overall quantum of the work may vary to any extent and if the scope of the work is reduced to any extent, the contractor shall not claim any compensation and no payment will be made towards claim/ compensation. If the quantum of the work get exceed tender amount, the contractor has to execute the work for additional amount at the same quoted percentage. This point shall be considered while quoting the tender.
8. **For extra/excess prior administrative approval of the competent approving authority mentioned in the circular u/no. CA(F)/Project/31 Dt. 26.10.2020 is mandatory for execution of extra/excess work. However, if quantities of excess items executed in the work is less than 5% prior/post facto approval of the competent authority shall be obtained.**

**However, prior administrative sanctioning authorities for excess/extra/saving are as per following table: -**

Nature of work	Permissible limit of Extra/Excess/Saving and approving authority		
General work/Underground works/Unforeseen works	<b>DMC(Infra)/DMC(E)/DMC(SE)/Dir(es &amp; p)/Jt.M.C.</b>  (i)Cumulative amount of Extra/Excess/Saving in any individual item upto Rs.25 Lakh and  (ii) Total cumulative amount of Extra/Excess/Saving on all items upto 5% of the total contract cost, but not exceeding Rs. 1 crore	<b>Concerned A.M.C.</b>  (i)Cumulative amount of Extra/Excess/Saving in any individual item upto Rs.1 crore and  (ii) Total cumulative amount of Extra/Excess/Saving on all items upto 15% of the total contract cost, but not exceeding Rs. 10 crore	<b>Municipal Commissioner</b>  (i)Cumulative amount of Extra/Excess/Saving in any individual item above Rs.1 crore and/OR  (ii)Total cumulative amount of Extra/Excess/Saving on all items above 15% of the total contract cost, And/OR  Cumulative amount of Extra/Excess/Saving in on all items exceeding Rs. 10 Crores

Nature of work	Permissible limit of Fair Item and approving authority		
For all nature of work	<b>DMC(Infra)/DMC(E)/DMC(SE)/Dir(es &amp; p)/Jt.M.C.</b>  Total cumulative amount of Fair on all items upto 2% of the total contract cost, but not exceeding Rs. 20 Lakh	<b>Concerned A.M.C.</b>  Total cumulative amount of Fair on all items upto 5% of the total contract cost, but not exceeding Rs.1crore	<b>Municipal Commissioner</b>  Total cumulative amount of Fair on all items above 5% of the total contract cost.  <b>And /OR</b> Cumulative amount of Fair on all items exceeding

		(Other than the proposals in the purview of DMC/Jt.MC)	Rs. 1 Crore.
--	--	--	--------------

For extra/fair items if any prior administrative approval shall be obtained from the AMC(P) & maximum limit is 5% of total contract cost.

Contractors are informed that the circular under reference is issued for the propose of having financial discipline on the work hence whenever the quantity executed to the extent of 80% of BOQ quantity will be intimated to Site In Charge before executing the work on site & or submission of R.A. bill for the said work. The extra/excess beyond the BOQ quantity are likely to be operative, the contractor need to take prior approval of competent authority. Any amendment in circular mentioned above during the time period of this tender will be applicable. The foreclosure of work due to above circular & reason will not be the cause of claiming compensation of this work.

**6.126 Special Notes:**

- 1) The pipe fabrication factory must have facility of automatic welding machine and hydraulic testing set up.
- 2) The spiral welding is not allowed for M.S pipes.
- 3) The contractor has to make arrangement for factory visit if instructed by Engineer in Charge Municipal staff at his own cost.
- 4) The contractor has to lay as far as possible the water mains at fixed level by diverting the utilities if required. Also preferably bends to be used while laying w.m. should be less than of 45 degree.

For extra item, if required to execute, any unforeseen work as per site conditions, HE's Schedule of rates will be mainly considered for the payment of work with proper sanction from DMC (SE). However, if the items are not available in HE's schedule those item will be paid as per the items of other BMC Schedule of rates & as stipulated in the relevant clause of G.C.C. If the items are not available in any of the B.M.C. schedules, then fair rate will be prepared as per prevailing market rate with 15% contractors profit inclusive of overheads and duly got verified by Account Office. For fair rate approval from DMC (SE) shall be obtained before execution of work or afterward as the case may be.

Contractors will be asked to refill the trenches with excavated earth with proper compaction as specified in clause PL 52 of Technical Specifications and reinstatement of Road surface to its original road surface. The width of road surface to be reinstated will be restricted to the trench width plus 15 cm on either side or as directed. The contractor has to maintain the reinstated trench and reinstated road surface till the defect liability period of the contract period is over at his cost. Any settlement of reinstated trench and/or reinstated road surface is observed during this period shall be redone within 7

days by contractor's at his cost failing which it will attract penalty equivalent to the cost of reinstatement (at quoted rate) of the portion per week or part thereof or as per the policy guidelines for re-instatement of trenches and the same will be recovered from the contractor's bill. However, during monsoon period if any pothole / settled trench is observed, it shall be binding on Contractors to attend it within 24 / 48 hours as the case may be and as directed by the Engineer.

**6.127 SITE INSPECTION:**

Before submitting the tender, the Tenderers / Contractors shall inspect and acquaint himself about the site of construction with its site constraints. They shall also collect such information as they may deem necessary for the proper execution of the works. They shall obtain further clarification, if any, on any specific issue from the office of E.E.W.W (Const) City, 1<sup>st</sup> floor, BMC Engineering HUB Building, Dr. E Moses Road, Worli, Mumbai-400018 before submitting the tender. Tenderers / Contractors should note and study the condition related to site constraints and its impact.

**6.128 SITE CONSTRAINTS:**

The Tenderers / bidders should note following points carefully before quoting:

- 1) For execution of proposed subject work along with its various allied work within contractual period the bidders has to carry out the work at number of locations as directed. Department will apply for necessary permissions to traffic department / Tree Authority / concerned B.M.C ward & any other agency as may be required. However, necessary follow ups shall have to be made by the contractor to get the permissions so as to start & complete the work within stipulated time period. Getting aforesaid permissions will be entirely contractor's responsibility for which the required help will be provided by B.M.C. Also, the directions of authority concerned with regards to traffic diversions / for any other purpose will be binding on the contractor..***
- 2) While carrying out the work, contractor has to ensure safety of existing utilities of B.S.N.L, B.E.S.T, TATA, SCADA, M.G.L, optical fibre cables, Sewer lines, S.W.D & Water Mains of Hydraulic Engineer's Department etc. contractor has to take care of all his Machineries and transport vehicles while executing the work without disturbing traffic flow on remaining carriageway of road. If any damage occurs to any immediately and no extra payment will be made to the contractors.**
- 3) Existing Cross Drainage work/HT cables /High voltage/oil filled TATA cables/ Drains etc may required to be crossed by way of diversions or by deepening the pipeline as directed. Utmost care should be taken while carrying out such works to avoid the damage to the existing utilities. If any damage occurs to any of the utility, same will have to be repaired /reinstated by the contractor at his cost immediately and no extra payment will be made to the contractor.**



- 4) It is to be ensured by the contractor that all valve chamber covers shall flush with the top of the existing road.
- 5) Due to paucity of space and to ensure better & consistent quality, it is necessary to provide Ready Mix Concrete (R.M.C) for the concreting works required for the project or as the case may be.
- 6) The warranty period of valves will however commence from the physical completion of entire work under the contract.
- 7) *The bidder shall note that he will have to arrange for security and safety of Municipal and his own staff working at the site & materials stacked at / near to sites during the whole contract period and the cost of same shall be deemed to have been covered under items of the contract. The bidders/Contractors should note that, no claim whatsoever arising out of the ignorance of site conditions etc. submitted later on, will be entertained on any account.*
- 8) As stated in scope of the tender, this tender covers the work of providing and laying of various dia. water mains & its allied civil works. The work of interconnections / cross Connections of various dia. water mains shall have to be done in restricted time limit as the existing water mains are live ones and it is to be carried out only after isolation for very restricted time period is permitted by Hydraulic Engineer.

**6.129 ASSISTANCE FOR THE ENGINEER'S STAFF:**

The Contractor shall provide all necessary assistance to the Engineer's Representative and his staff in carrying out their duties of checking, setting out, inspecting and measuring the works. The Contractor shall provide surveyor, staff men, office attendants and labourers as may be needed from time to time by the Engineer.

The Contractor shall provide for Engineer and his staff protective clothing, safety helmets, rubber boots of suitable sizes, hand lamps, and the likes as may reasonably be required by them. These articles shall remain the property of the Contractor. No separate payment shall be made on this account.

**6.130 SAFETY MEASURES AND SERVICES:**

The Contractor shall be responsible for the safety of all workmen and other persons entering the works and shall take all measures necessary to ensure their safety to the approval of the Engineer's Representative. The guidelines are as under:

- a) Display of proper safety and emergency regulations; fire, gas and electric shock precautions, provisions of stretchers and first aid boxes together with rescue facilities for each place of working.
- b) Provision of efficient safety helmets for all personnel including the Engineer's Representative and each of his staff and any authorized visitors.
- c) Safe control of water, including provision of ample standby generating and pumping plant;
- d) Provision and maintenance of suitable lighting to provide adequate illumination of works with appropriate spares and standby equipment;
- e) Provision and maintenance of safe, sound mechanical equipment each item of plant having an up-to-date test certificate;
- f) Provision and maintenance of safe, sound ropes, slings, pulleys and other lifting tackle, each appliance having an up-to-date test certificate where appropriate;
- g) Provision of notice board 1.25 m x 1.5 min size, written in bold letter in English, Marathi and Hindi, to be erected on existing footpaths and points of access likely to be used by the public, which shall warn the public.

**6.131 IDLE CHARGES:**

No idle charges will be entertained on any of the grounds.

**6.132 PENALTY CLAUSE:**

- a) The Engineer not below the rank of Assistant Engineer is entitled to impose a penalty of Rs. 5000/- per day/lapse, in accordance to the gravity of default communicated in writing. Penalty amount will be recovered from contractors running bill. This penalty is over and above penalty mentioned under G.C.C.

If it is observed that, the contractor carrying out the work fails to comply with the instructions given by the authorities of the Dy.HE (Const)/H.E/D.M.C (SE) /A.M.C/M.C.'s level during execution of work twice, the work may be terminated and will be carried out at the risk and cost of the contractor and penal action will be taken against them. This decision will not be arbitrable at all.

The abovementioned condition will be in addition to the relevant condition in the General Condition of contract regarding cancellation of contract in full or partly final decision of disputes, difference of claims raised by the contractor or relating to any matter out of contract.

Penalty shall be levied & recovered from contractors running bills as stated below. This penalty is over and above penalty mentioned under G.C.C / other Terms & conditions mentioned in this tender.

<i>Sr.No</i>	<i>Reasons</i>	<i>Amount of Penalty</i>
1	<i>Work not as per specification/defective work</i>	<i>20% of cost of defective work. The defective work is to be redone/rectified.</i>
2	<i>Lapse in execution of work as discussed &amp; finalized during the quarterly review meeting of the work at site.</i>	<i>Minimum Rs 10000 / - per day &amp; then Rs 5000 / - per day</i>
3	<i>Not following / disobedience of orders issued by site incharge or other visiting officers of the B.M.C.</i>	<i>Rs 5000 / -per day</i>

In case of failure of asphalt mix sample testing in Municipal Testing Laboratory in various tests the following penalties will be imposed.

<i>Sr. No</i>	<i>Particulars</i>	<i>Penalty</i>
1	<i>Gradation Failure in asphalt macadam(AM), asphalt concrete(AC), seal coat(SC)</i>	<i>Rs. 5000 / -</i>
2	<i>Gradation failure in mastic asphalt (MA)</i>	<i>Rs. 5000 / -</i>
3	<i>Failure on more than three(3) gradations in AM,AC,MA</i>	<i>50% of the cost of the work done representing the sample</i>
4	<i>Failure in flow value, bulk density, void ratio, marshal stability</i>	<i>Rs1000 / -</i>
5	<i>Excess bitumen content beyond specified limits</i>	<i>Rs.150 / - per M.T for the work representing the sample.</i>
6	<i>Less percentage of bitumen content in asphalt mix/es.</i>	<i>50% of the cost of work representing the sample.</i>
7	<i>For other materials failure</i>	<i>Rs 5000 / - per material per failure</i>

### **Other penalties**

In addition to any penal action under the General Conditions of Individual contracts, a registered contractor will be liable under the registration rule to one or more of the following penalties:

- a) Warning / Fine
- b) Demotion
- c) Deregistration

#### **a) Warning / Fine**

A contractor will be liable to a warning and /or penalty for:

1. Non-compliance of any provision of the rules.

2. Failure to comply with any clause or direction under these rules or comply with any conditions of tenders / contracts.
3. Inadequate progress / performance under the contract.

For the first default of any type mentioned above a warning will be issued. For each subsequent default of the types in (1) & (2) above the minimum penalty will be fine of **Rs 2500/-** while that for a default of the type (3) the minimum penalty will be **Rs 5000/-** for contracts of upto Rs 25 Lakhs and **Rs 10000/-** for contracts of above Rs 25 lakhs. Higher Amount of penalty may be levied by the competent authority for reasons to be recorded.

**b) Demotion**

A contractor will be liable to be demoted to a lower class of registration on any of the following grounds:

1. Specific failure or default in execution of individual works in respect of physical progress for quality of such works.
2. Inadequate performance as revealed by quarterly performance report.
3. Deterioration in financial or technical ability /capacity.
4. Repeated failure to fill in tender documents fully and correctly or delay in execution of formal contract documents.

**c) Deregistration:**

A contractor will be liable to be deregistered on any of the following grounds.

- 1 Attempt to defraud the Corporation.
- 2 Attempt to bribe any employee / officer of Corporation.
- 3 Attempt to secure a contract through unfair means or by bringing to bear outside influence.
- 4 Attempt to secure unauthorized copies of Municipal Records, any documents in relation to any tender / contract or any other official matter.
- 5 Furnishing or tampered with Municipal record and documents.
- 6 Furnishing false and / or misleading information to registration and / or any tender / contract.
- 7 Threatening, Misbehaving with or physical attack on any Municipal Employees / officer.
- 8 Attempt to instigate or collude with other contractors with a view to securing undue advantage.

**6.133 Condition for updating of works on BMC GIS**

- 1) Contractor has to capture digital photographs and Geo coordinates (i.e. Latitude and Longitude) of each work (during execution of the work) In the following manner:

- a) Contractor shall use latest GPS equipment in DGPS mode (RTK/PPK) for capturing Latitude/Longitude coordinates of Water Network Assets, which are compatible to the MCGM's existing DGPS Setup to get desired data quality.
- b) The GPS coordinates shall be captured strictly in the presence of the concerned MCGM Site in charge. The photographs of the process of capturing the Geo coordinates with the help of latest DGPS Machine shall be taken and submitted as part of records to the concerned EEWW(Const).
- c) The contractor shall capture the coordinates of water network assets and post process the DGPS Rover data in back office and generate "shape file" format using the 10 point character for attribute table as attached which is mandatory for uploading on One MCGM. Reference coordinates for shape file shall be WGS 1984 UTM 43N.
- d) For water mains, contractor shall capture Geo coordinate in the following manner:
- i) At start point, at every turning point and end point.
  - ii) Every bend shall be captured at both the ends to confirm the direction of water main.
  - iii) For straight alignment of water main, Geo coordinates shall be taken at every 50m interval.
  - iv) The coordinates of all Cross-connection points, Sluice valves, Valve chamber, BFVs, Air valves, Hydrants, Reducer, End cap, Manhole chamber, shall also be captured.
- e) In congested area where network is not available or poor, submission on Google Earth can be accepted for WDIP work only and not for laying work.
- 2) The contractor shall enter the field attribute data in the asset format attached and submit along with shape file for GIS Mapping Certificate.
- 3) a) Wherever necessary the contractor shall carry out TSS survey of Road where laying of water main work is to be executed. For TSS, use nearest MCGM's GCP monuments (total 24 monuments are available across Greater Mumbai) for reference.
- b) For TSS survey. The contractor shall use UTM 43N using local datum (THD values from the nearest pillar) as directed by MCGM. Three-point location data should be given with field attribute data as per Asset formats attached along with the shape file and submit to the department. All water related features i.e. Pipe lines, valve chamber, hydrant, air valve etc. shall be marked on TSS with reference to urban vicinity features such as land mark, bus top, electrical poles, sewer main holes etc.

- 4) Tenderer shall also submit a certified hard copy of the surveyed data on Google earth map. It is also mandatory to submit detailed schematic sketch signed by concerned construction staff for assets such as cross connection, water main, diversion, reducer and service connection.
- 5) The attribute data of the H.E.'s assets shall be filled up in the prescribed formats as attached by Concern Contractor's representative and the site in charge, which shall be endorsed by concerned Executive Engineer.
- 6) The completion drawings shall be prepared using HE's existing GIS data/One MCGM portal available with Executive Engineer (Construction).
- 7) After completion of work, the geo spatial data in "shape file", along with attribute data in prescribed formats as attached, shall be submitted to EE(WDIP) for updating in H.E.'s GIS database within two month, failing which a penalty of Rs. 500 per day will be recovered from the contractor.
- 8) It is required to capture the geo spatial data on exposed main while carrying out the work for better accuracy in order to update HE's GIS data.
- 9) Tenderer shall note that, 5% amount of the total work done will be withheld for GIS work. The 5% deposit withheld will be released only after GIS Mapping Certificate is received from MWDIP department. This 5 % Retention shall be in addition to the amount retained as retention money and amount withheld as per vigilance circular. Running bill/final bill shall be accompanied with GIS Mapping Certificate as per circular CA(F)/EXP/F1/22 Dated 30.09.2019.
- 10) The contractor shall note that no separate payment will be made for capturing GPS coordinates, carrying out TSS survey wherever required, and submission of photographs, CD of Auto CAD &shape files etc.
- 6.134** Any update in GIS conditions / circulars will be applicable for this work even after the completion of bidding process and during execution. The Contractor should note that Running Bill/Final Bill of project works shall be accompanied with GIS Mapping Certificate as per Circular no. CA(F)/EXP/FI/22 dated 30.09.2019. If any Running Bill / Final Bills not accompanied with GIS Mapping Certificate, the same will not be accepted for payment.
- 6.135** Tenderer shall note that no extra payment shall be made for local transportation of MS pipes and MS specials at site and rates are inclusive of transportation and lowering in trenches.
- 6.136** The Tenderer shall take note of the GST circular issued u/n.CA/F/Project/28 dt. 28.03.2023 (Pg.271-273). Any modifications to this effect will be applicable to this bid. However it shall be noted that rates are as per USOR 2023 exclusive of G.S.T. and applicable G.S.T. will be paid over and above the rates quoted by bidders.

- 6.137** The appointed agency has to take measures and implementation of Mumbai's Air pollution mitigation plan issued under no. MGC/A/1386, dtd. 13.03.2023. **(pg. no.281.)**
- 6.138** The appointed agency has to follow the circular issued under no. HE/01/Cir. Dt. 11.05.2022 (pg. no. **282**) regarding certification of work executed.
- 6.139** The bidders shall note the circular u/n. CA/Finance/Project/19/dt.04.03.2024. **(Pg.290-292).**
- 6.140** The intending tenderer shall note that, the items in the Bill of Quantities related to the reinstatement of trenches are provisional only and same may be given to other agency for execution either partially or fully or may not be executed at any point of time through other BMC department as per the decision of the Municipal Commissioner/Engineer in charge during the tendering procedure or during the contract period. Intending tenderer have to carry out the work in coordination with road department and have to co-operate with other agency/department for this road work during execution. The tenderer shall note this & cannot claim for non-execution.
- 6.141** The execution of reinstatement items mentioned in the BOQ may not be required to be operated during execution and contractor shall not claim regarding non execution of these items.
- 6.142** Though the time period for the work is calculated by considering certain work fronts to be started at a time, contractor may have to start more work fronts simultaneously as per the progress of road department.
- 6.143** Any update in GIS conditions/circular will be applicable for this work even after the completion of bidding process and during execution.
- 6.144** Proposal regarding the reinstatement work of trenches through H.E. contractor and use of sand metal for that R.I. work is approved by Hon'ble AMC(P) u/no. AMC/P/2577 dated 08.08.2024. The quantities required for R.I. work is considered accordingly. However, in case of trenches taken in DLP Roads/Project Roads R.I. will be done by Roads Department and quantities considered for reinstatement items may not be utilized and related amount will be considered for saving. Any claim from contractor in this regard, will not be entertained and considering at all. The contractor should quote accordingly.
- 6.145** While executing the item of Sand Metal (R3-RW-10-24), Contractor appointed any Engineer should be present on each site. Laying of sand metal should be done preferably during working hours (Day time). It is mandatory to maintain Timestamp Photograph while laying of Sand Metal in presence of Contractor's appointed Engineer for each task with measurements. Bidder should note that, if photographs as mentioned above is not found maintained for each task no payment for the said item will be made.

**Concerned Site Engineer to ensure execution of Sand Metal on site and see that photograph of each task as mentioned above and challans are properly maintained in record before making payment for the same. Concerned A.E./E.E. May check laying of Sand Metal by taking random trail pits and photographs of trail pits should be maintained in record.**

**If it is observed that the reinstatement of trench is done without Sand Metal, penalty of equivalent amount will be imposed on the contractor and the entire trench will be removed and redone. If repeated lapse observed action as per tender condition & G.C.C will be proposed which please may be noted.**



# **SECTION 7**

# **SCOPE OF WORK**



## SCOPE OF WORK

**This particular tender comes under the category of “Regular, Routine and Maintenance works/  
Original and New construction works/ For Other Special works”.**

**The scope of work consists of: -**

Following works are included for - **(HE-C-CT-CCRD-06) Laying/Replacement of various dia. water mains due to proposed improvement of roads in cement concrete in C ward & D ward of city section (2024-2026).**

**C-ward:**

Sr. No.	Sr. No.	Ward	Name of Road/Location	Dia of water main mm	Length of water main Mtrs	Remarks Mtrs	E.E.W.W.(P&R) approved/Pending
			Name of Road				
1	C-1	C	VP Road	150	90	TOC/IC	Advance copy received from AEWW' C' ward
2	C-2	C	Chandanwadi Road	150 & 250	580	TOC/IC	
3	C-3	C	Durgadevi Street	150	620	TOC/IC	
4	C-4	C	RS Sapre Marg	100 & 150	340	TOC/IC	
5	C-5	C	1st Panjarapole Lane	150	300	TOC/IC	
6	C-6	C	2nd Duncon Cross Lane	150	240	TOC/IC	
7	C-7	C	Vijaywadi Road	150	280	TOC/IC	
8	C-8	C	Tadwadi Road	150	250	TOC/IC	
9	C-9	C	Sitaram Poddar Marg	250 & 300	620	TOC/IC	
10	C-10	C	Bhandari Street	150	780	TOC/IC	
11	C-11	C	Ratansi Champsi Marg	150	160	TOC/IC	
12	C-12	C	H Cross Road	150	135	TOC/IC	
13	C-13	C	Nakoda Street	150	100	TOC/IC	
14	C-14	C	Ropa Lane	150	160	TOC/IC	
15	C-15	C	Bhaskar Lane	150	160	TOC/IC	
16	C-16	C	N S Road	250 & 350	1080	TOC/IC	
17	C-17	C	Popatwadi Road	150	180	TOC/IC	
18	C-18	C	2nd Fanaswadi	150	272	TOC/IC	
19	C-19	C	Bapu Khote (Side Strip)	150	800	TOC/IC	
20	C-20	C	C P Tank (Side Strip)	150	600	TOC/IC	
21	C-21	C	M K Road (Side Strip)	250	200	TOC/IC	
22	C-22	C	Patthe Bapurao Marg (Side Strip)	150 & 250 & 300	765	TOC/IC	
23	C-23	C	Bara Imam Road	150	1100	TOC/IC	
24	C-24	C	Cavel Street	150 & 300	600	TOC/IC	
25	C-25	C	Kitchen Garden Lane	150	130	TOC/IC	
26	C-26	C	Shrikant Palekar Marg	150 & 250	600	TOC/IC	
27	C-27	C	New Kazi Street	250	600	TOC/IC	
28	C-28	C	Gujjar Street	150	340	TOC/IC	

29	C-29	C	Baniyan Street	150 & 250	380	TOC/IC	Advance copy received from AEWW' C' ward
30	C-30	C	Mirza Street	150 & 250	280	TOC/IC	
31	C-31	C	Vitthal Das Road	150 & 250	330	TOC/IC	
32	C-32	C	JSS Road	150 & 250	2200	TOC/IC	
33	C-33	C	Dhanji Street	150	380	TOC/IC	
34	C-34	C	Dharmsi Lane	150	200	TOC/IC	
35	C-35	C	3rd Agyari Lane	150	180	TOC/IC	
36	C-36	C	3rd Cavel Street	150	200	TOC/IC	
37	C-37	C	Bapu Khote Cross Lane	150	80	TOC/IC	
38	C-38	C	Maulana Shaukat Ali Road	150	590	TOC/IC	
39	C-39	C	SVP Road (Side Strip)	150	1600	TOC/IC	

**D-ward:**

Sr. No.	Sr. No.	Ward	Name of Road/Location	Dia of water main	Length of water main	Remarks	E.E.W.W.(P&R) approved/ Pending
			Name of Road	mm	Mtrs	Mtrs	
1	D-1	D	Padmaja path	150	300	TOC/IC	Advance copy received from AEWW'D' ward
2	D-2	D	Pathe bapurao marg (lower level sankalp sid-dhi)	150	160	TOC/IC	
3	D-3	D	Dr bharucha path	150	80	TOC/IC	
4	D-4	D	Hinduja collage lane	80	80	TOC/IC	
5	D-5	D	Pav wala street	150	360	TOC/IC	
6	D-6	D	Ardesir dadi street	150	300	TOC/IC	
7	D-7	D	Jalbhai path	150	240	TOC/IC	
8	D-8	D	Chunam lane	150	90	TOC/IC	
9	D-9	D	Dr PG solanki path	250	170	TOC/IC	
10	D-10	D	Dinanath mangesh road	-	-	RSC/IC	
11	D-11	D	Gilder cross lane	-	-	RSC/IC	
12	D-12	D	Jairaj bhai lane	-	-	RSC/IC	
13	D-13	D	Mount unique road	-	-	RSC/IC	
14	D-14	D	Shamrao vitthal marg	-	-	RSC/IC	
15	D-15	D	Rungtha cross lane	-	-	RSC/IC	
16	D-16	D	Shankar seth raod	-	-	RSC/IC	
17	D-17	D	Bhaushaheb hire cross road	-	-	RSC/IC	
18	D-18	D	Darabsha lane	-	-	RSC/IC	
19	D-19	D	Krantiveer rajguru road	-	-	RSC/IC	
20	D-20	D	Khetwadi 10th lane	-	-	RSC/IC	
21	D-21	D	Papanswadi	-	-	RSC/IC	
22	D-22	D	Bai dinabai street	-	-	RSC/IC	
23	D-23	D	Moti bai path	-	-	RSC/IC	
24	D-24	D	Ladypochkhan wala path	-	-	RSC/IC	

25	D-25	D	Trimbak parshoram marg	-	-	RSC/IC
26	D-26	D	Wadia path	-	-	RSC/IC
27	D-27	D	Dadiseth road	-	-	RSC/IC
28	D-28	D	Sir ratan tata path	-	-	RSC/IC
29	D-29	D	Awabai kasinath path	-	-	RSC/IC
30	D-30	D	Runghta lane	-	-	RSC/IC
31	D-31	D	Gilder lane	-	-	RSC/IC
32	D-32	D	Vaccha gandhi road	-	-	RSC/IC
33	D-33	D	Nath madhav lane	250	-	RSC/MSV/IC
34	D-34	D	Dr wilson path	-	-	RSC/IC
35	D-35	D	Deshbhakt AB kholhatkar marg	-	-	RSC/IC
36	D-36	D	LD ruparel X lane 2	-	-	RSC/IC
37	D-37	D	Dadiseth 2nd X lane	-	-	RSC/IC
38	D-38	D	Tribhuvan road	-	-	RSC/IC
39	D-39	D	Walkeshwar road	250	-	RSC/MSV/IC
40	D-40	D	Raghavji road	-	-	RSC/IC
41	D-41	D	Tejpal road	-	-	RSC/IC
42	D-42	D	PG solanki path	-	-	RSC/IC
43	D-43	D	Dadiseth 1st X lane	-	-	RSC/IC
44	D-44	D	Smt Khadiza Tayyebji marg no 2	-	-	RSC/IC
45	D-45	D	Bhai magandas marg	-	-	RSC/IC
46	D-46	D	JSS road	250 & 300	-	RSC/MSV/IC
47	D-47	D	Mathew road	-	-	RSC/IC
48	D-48	D	Manavmandir road	-	-	RSC/IC
49	D-49	D	Babulnath road	-	-	RSC/IC
50	D-50	D	Peddar road	-	-	RSC/IC
51	D-51	D	Bomanji petit road	-	-	RSC/IC
52	D-52	D	Sadashiv X lane	-	-	RSC/IC
53	D-53	D	Krishna sanghi path	-	-	RSC/IC
54	D-54	D	Proctor Road	-	-	RSC/IC
55	D-55	D	Wadilal petel road	-	-	RSC/IC
56	D-56	D	BG kheir road	-	-	RSC/IC
57	D-57	D	Bhaushaheb hire marg	-	-	RSC/IC
58	D-58	D	Waste field compound lane	-	-	RSC/IC
59	D-59	D	Dr rajabali patel marg	-	-	RSC/IC
60	D-60	D	Navroji gamadia lane	-	-	RSC/IC
61	D-61	D	ML dhanukar lane no 1	-	-	RSC/IC
62	D-62	D	ML dhanukar lane no 4	-	-	RSC/IC
63	D-63	D	ML dhanukar lane no 6	-	-	RSC/IC
64	D-64	D	Gamadia colony road	-	-	RSC/IC
65	D-65	D	Shimla house road	-	-	RSC/IC
66	D-66	D	LD ruparel X lane 1	-	-	RSC/IC
67	D-67	D	AG bell marg	-	-	RSC/IC

Advance copy  
received from  
AEWW'D'ward

68	D-68	D	Morvi lane	-	-	RSC/IC
69	D-69	D	Tata road no 1	-	-	RSC/IC
70	D-70	D	Dr bhajekar marg	-	-	RSC/IC
71	D-71	D	Ardeshir dadistreet	-	-	RSC/IC
72	D-72	D	Banganga road	-	-	RSC/IC
73	D-73	D	Pathe bapurao marg	-	-	RSC/IC
74	D-74	D	Mangalwadi road	-	-	RSC/IC
75	D-75	D	Bhanji bhai rathod marg	150	-	RSC/MSV/IC
76	D-76	D	Kalamaharshi hal-dainkar low level	-	-	RSC/IC
77	D-77	D	Badam galli	-	-	RSC/IC
78	D-78	D	Mugbhat lane	-	-	RSC/IC
79	D-79	D	Jagannath street	-	-	RSC/IC
80	D-80	D	Ardeshir dubas lane	-	-	RSC/IC
81	D-81	D	Mahila pathe agyari lane	-	-	RSC/IC
82	D-82	D	BB Nakashe road	-	-	RSC/IC
83	D-83	D	Walkeshwar road (Teen batti to raj bhavan )	-	-	RSC/IC
84	D-84	D	Dr Atmaram rangnekar road	-	-	RSC/IC
85	D-85	D	Parshiwada 2nd lane	-	-	RSC/IC
86	D-86	D	Parshiwada 1nd lane	-	-	RSC/IC
87	D-87	D	Baburao more marg	-	-	RSC/IC
88	D-88	D	Md. Tahir ansari marg	-	-	RSC/IC
89	D-89	D	Sane guruji marg	-	-	RSC/IC
90	D-90	D	Dadashaheb vichare marg	-	-	RSC/IC
91	D-91	D	NS pathkar road	-	-	RSC/IC
92	D-92	D	Keshavrao khade marg	-	-	RSC/IC
93	D-93	D	Khetwadi back road	-	-	RSC/IC
94	D-94	D	lamington road	-	-	RSC/IC
95	D-95	D	R thakkar road	-	-	RSC/IC
96	D-96	D	Sitaram gadigaonkar marg	-	-	RSC/IC
97	D-97	D	Tardeo road	-	-	RSC/IC
98	D-98	D	Javaji dadaji road	-	-	RSC/IC
99	D-99	D	RS nimkar marg	-	-	RSC/IC
100	D-100	D	Balaram Street	-	-	RSC/IC
101	D-101	D	Setlewad lane	-	-	RSC/IC
102	D-102	D	Khetwadi 12th lane	-	-	RSC/IC
103	D-103	D	Labornam marg	-	-	RSC/IC
104	D-104	D	Parshuram pupala marg	-	-	RSC/IC

Advance copy  
received from  
AEWW'D'ward

105	D-105	D	Dr deshमुख galli	-	-	RSC/IC	Advance copy received from AEWW'D'ward
106	D-106	D	Vivek singh lane	-	-	RSC/IC	

Provision for RSC work in C ward is also made in BoQ.

Sr.no	Size of water main	Proposed Length	Provisional Length for Unforeseen work (15%)	Total Length
1	80 mm	670	101	110
2	100 mm	610	92	696
3	150 mm	13282	1993	9498
4	250 mm	5025	754	11017
5	300 mm	1385	208	3750
	<b>Total</b>	<b>20972</b>	<b>3148</b>	<b>24120</b>

Along with its allied works (i.e. Laying, encasement, cross connection work, Hydraulic Testing, discarding of old mains, commissioning of newly laid main, & Reinstatement work ... etc.)” and any other works as per the site requirement suggested/proposed by AEWW of respective Ward /AEWW(Maint) of respective ward / EEWW(P&R) or as directed by Engineer.

**Note: - Intending tenders shall carefully read the tender conditions 6.114 (i.e. Special Directions to E-Tenderers) & 6.115 (Special Conditions of Contract) before submitting their bid.**

**This page is intentionally kept Blank**



**This page is intentionally kept Blank**

**This page is intentionally kept Blank**

**This page is intentionally kept Blank**

**This page is intentionally kept Blank**

**SECTION 8**

**BILL OF QUANTITIES**



## Brihanmumbai Municipal Corporation

Hydraulic Engineer's Department

### Abstract Sheet

**Name of Work:- (HE-C-CT-CCRD-06) Laying/Replacement of various dia. water mains due to proposed improvement of roads in cement concrete in C ward & D ward, and other wards of city section (2024-2026).**

Sr. No.	Item No.& Description	Quantity	Unit	Rate	Total amount
1	<b>R3-CS-EW-3</b>				
	Excavation for foundation, substructures, basements, tanks, sumps, walls, chambers, manholes, trenches, poles, pits & general building works in soft/ disintegrated rock, sand stone, stiff clay, gravel, cobblestone, hard laterite, water bound macadam, wet mix macadam, asphalt mix carpet of any type, pitching, soling, paths and hardcore, lime concrete, plain cement concrete, stone masonry and all types of brick/ block masonry below ground level, rock boulders, etc.				
		15571.00	Cum	644	10027724
2	<b>R3-CS-EW-1</b>				
	Excavation for foundations, substructures, basements, tanks, sumps, walls, chambers, manholes, trenches, poles, pits & general building works in all types of soils, vegetable earth, soft murum, running sand, shingle, turf clay, loam, peat, ash, shale, slag, chalk, garbage, muddy/ marshy/ slushy soil, marine clay, reclaimed land etc				
		34857.00	Cum	387	13489659
3	<b>R3-CS-EW-2-a</b>				
	Exc in soil for 1.5 to 3 mtr.depth etc. as per item.				
		7073.00	Cum	91	643643
4	<b>R3-RW-10-49</b>				

	<b>Excavation in reinforced OR pavement grade concrete M-20 &amp; above by using modern machinery (poclain with rock breaker, etc.) including with stacking of excavated material within 150 m radius etc. complete upto any depth as specified &amp; as directed, by the Engineer. Extra over to use sleep form paver to l</b>				
		932.00	Cum	1663	1549916
5	<b>R3-HE-8-27-a</b>				
	<b>Cutting of exsisting cement concrete road upto specified depth by using Diamond Saw machine etc. complete in all respects and as directed by Engineer In Charge. Note : The charges for supplying water and electricity are exclusive of the rate worked out.</b>				
	a) Upto 350 mm depth of cutting				
		3128.00	Rmt	1308	4091424
6	<b>R3-HE-1-3</b>				
	<b>Supplying, lowering, laying and jointing in trenches C.I. Class 'LA' , S/S pipes conforming to IS:1536 with CI / MS specials of following diameter including chamfering cut edges of pipes for specials and fixing with Styrene Butadiene Rubber (SBR) gas-kets conforming to IS:5382 &amp; IS:12820 in proper position, grade and alignment etc complete in all respect and as directed by Engineer in Charge etc.</b>				
	a) 80 mm				
		387.00	Mtr	1268	490716
7	<b>R3-HE-1-6</b>				



	<b>Providing &amp; Supplying, loading, transporting on site, unloading, lowering in trenches, assembling and jointing Ductile Iron pipes ( K-9) including chamfering cut edges of pipes and specials and fixing with Styrene Butadiene Rubber (SBR) Ring Gaskets for following diameters (Tyton joint pipes). The pipe shall confirm IS : 8329 &amp; SBR Ring Gasket shall confirm IS : 5382 &amp; IS : 12820. The rate is inclusive of cleaning, flushing &amp; testing of water mains upto 6 kg/sq.cm etc complete in all respect and as directed by Engineer in Charge (Pipe shall be coated with cement mortar lining from inside and zinc coating followed by bitumen coating from outside as specified).</b>				
	a) 80 mm dia.				
		771.00	Mtr	1083	834993
	b) 100 mm dia.				
		702.00	Mtr	1260	884520
	c) 150 mm dia				
		15275.00	Mtr	1812	27678300
	d) 250 mm dia				
		5779.00	Mtr	2665	15401035
	e) 300 mm dia.				
		1593.00	Mtr	3923	6249339
<b>8</b>	<b>R3-HE-6-1A</b>				
	<b>Providing and fixing CI Mechanical joint collars suitable for CI/DI pipes, (dimensionally described in Table - 13 of IS : 13382/1992) inclusive of sealing rubber gasket of SBR (dimensionally described in IS :12820/1989 ), follower gland of CI and MS nut bolts zinc coated or otherwise protected from rusting etc complete as directed by Engineer in Charge</b>				
	a) 80 mm dia.	73.00	Each	1105	80665
	b) 100 mm dia.	73.00	Each	1207	88111
	c) 150 mm dia.	532.00	Each	1999	1063468
	e) 250 mm dia.	171.00	Each	3156	539676
	f) 300 mm dia.	36.00	Each	4181	150516
<b>9</b>	<b>R3-HE-6-3</b>				

	<b>Providing and fixing CI Mechanical joint Double Socket any degree bends, (dimensionally described in IS :13382 /1992) inclusive of Sealing Rubber Gasket of SBR (dimensionally described in IS : 12820), Cast Iron Follower Gland and Mild Steel Nut Bolts zinc coated or otherwise protected from rusting and suitable for CI/DI pipes etc complete as directed by Engineer in Charge</b>				
	a) 80 mm dia.	18.00	Each	2370	42660
	b) 100 mm dia.	18.00	Each	2851	51318
	c) 150mm dia.	409.00	Each	5124	2095716
	e) 250 mm dia.	156.00	Each	10448	1629888
	f) 300 mm dia.	44.00	Each	15055	662420
10	<b>R3-HE-1-9</b>				
	<b>Cutting of cast iron and CI/DI pipes of all classes with cutting tools, cutting machine and chamfering the edges etc complete in all respect and as directed by Engineer in Charge and for following diameters.</b>				
	a) 80 mm dia	180.00	Each	499	89820
	b) 100mm dia	1208.00	Each	607	733256
	c) 150mm dia	1226.00	Each	694	850844
	d) 250 mm dia	467.00	Each	844	394148
	e) 300 mm dia.	134.00	Each	1070	143380
11	<b>R3-HE-2-19</b>				

	<p><b>Providing &amp; Supplying, loading, transporting on site, unloading, lowering in trenches, assembling and jointing mild steel pipes to site of work fabricated in any ISI/ ISO certified company, from mild steel plates of approved quality and thickness, confirming to IS 3589 . The M.S plates shall be procured only from Jindal,TATA met-talics,SAIL, ESSAR or Ispat Steel. The test certificates and Challans from the manu-facturer of plates shall be submitted to the corporation. The item includes marking, cutting, rolling bending, welding using automatic submerged arc type welding ma-chine, factory testing of pipes, loading at fabrication yard/ factory transportation to site of work/ any municipal store using truck/ trailer, unloading and stacking near place of work etc complete as specified and as directed by Engineer in Charge. . Each pipe shall be about 5 to 7.5 mtr. long, fab-ricated as per IS:3589 and suitable for 10 kg/cm2 working pressure( spirally welded pipes fabricated from strips are not ac-ceptable). "No separate payment will be made for local transport at Site."</b></p>				
	a) 80 mm dia.	79.00	Mtr	1071	84609
	b) 100 mm dia.	72.00	Mtr	1314	94608
	c) 150 mm dia.	1529.00	Mtr	1925	2943325
	d) 250 mm dia.	579.00	Mtr	3110	1800690
	e) 300 mm dia.	160.00	Mtr	3667	586720
12	<b>R3-HE-2-2</b>				
	<p><b>Supplying mild steel specials of required length and degree to site of work / any municipal store fabricated in any ISI/ ISO certified company, from mild steel plates of approved quality and thickness, confirming to IS 3589 . The M.S. plates shall bare cor-responding ISI mark. The item includes marking, cutting, fit up, rolling bending, welding using automatic submerged arc type welding machine, factory testing of pipes, loading at fabrication yard/ factory transportation to site of work/ any municipi-pal store using truck/ trailer, unloading and stacking near place of work etc com-plete as specified and as directed by Engi-neer in Charge.Fabrication work to be car-ried out as per IS:3589 and suitable for 10 kg/cm2 working pressure.</b></p>				

	a) 80mm dia .	6.00	Mtr	944	5664
	b) 100mm dia.	5.00	Mtr	1164	5820
	c) 150 mm dia.	87.00	Mtr	1710	148770
	d) 250 mm dia.	34.00	Mtr	2810	95540
	e) 300 mm dia.	11.00	Mtr	3360	36960
13	<b>R3-HE-2-12</b>				
	<b>Field welding in all position with required number of runs, for M.S. pipes internally and/or externally including gauzing wherever necessary, fixing appurtenances and other accessories in connection of pipe laying work as per specification etc complete as specified and as directed by Engineer in Charge.</b>				
	c) 6 mm thk				
		2921.00	Mtr	1388	4054348
14	<b>R3-HE-2-13</b>				
	<b>Field welding in all position with required number of runs, for M.S. pipes internally and/or externally including gauzing wherever necessary, fixing appurtenances and other accessories in connection of pipe laying work as per specification etc complete as specified and as directed by Engineer in Charge.</b>				
	Lap Jointing with convex fillet weld				
	b) Leg length 6 mm				
		293.00	Rs/Rmt	654	191622
15	<b>R3-HE-2-14</b>				
	<b>Gas cutting (either square cut or V cut) pipes, plates etc. complete as specified and as directed by Engineer in Charge. of following thickness</b>				
	b) above 5mm upto 10 mm				
		3214.00	Mtr	368	1182752
16	<b>R3-HE-3-6</b>				

	<b>Supplying, Loading, transporting on site, unloading, ISI mark Glandless, Double Flanged sluice valves of PN 1.0 conforming to IS - 14846 in Grey Cast Iron IS: 210-1978 FG-260 without Bevel gear arrangement along with its complete appurtenances (i.e. including two nos. of tail pieces) &amp; nuts, bolts, washers, packings etc., stacking the same as directed on site, hoisting, lowering and positioning the same in true plumb and level with tapers, saddles, flanges, etc. on live mains on CI / DI or MS water mains and for PE pipes along with Long Neck PE and flange for following diameters. Note : Sluice valves and all other materials supplied shall be as per the acceptance criteria of MCGM as given in specification.</b>				
	a) 80 mm dia				
	For stub	147.00	Each	17446	2564562
	b) 100 mm dia				
	for stub	91.00	Each	22053	2006823
	d) 150 mm dia	113.00	Each	35069	3962797
	f) 250 mm dia	52.00	Each	68704	3572608
	g) 300 mm dia	19.00	Each	83506	1586614
17	<b>R3-HE-3-16</b>				
	<b>Supplying, loading, transporting on site, unloading butterfly valves of PN 1.0 conforming to AWWA C-504 in SGI- IS 1865(Grade 500/7) material with appurtenances and flange adaptors, nuts, bolts, washers, packings etc. stacking the same as directed on site, hoisting, lowering and positioning the same in true plumb and level with tappers, saddles, branches flanges etc. on CI / DI or MS water mains and for PE pipes along with Long Neck PE and flange for following diameters. (Manually operated). The flange adapter used here conforms to AWWA C-219. Note : Butterfly valves, flange adaptors and all other materials shall be supplied as per the acceptance criteria of MCGM as given in specification.</b>				
	b) 450 mm	4.00	Each	198049	792196

18	<b>R3-HE-8-26</b>				
	Supplying, transporting and fixing S.P. fire hydrants including mouth piece, duck foot bend, S.V. as per specifications & drawing, fixing flanged socket, supplying and laying C.I./ M.S. pipe up to 2 mtrs. length and jointing the same with spun yarn, molten lead, including caulking etc. complete as directed & as specified by Engineer In Charge. (as per IS : 908) Note: Construction of valve chamber will be paid separately				
	at both end of road	148.00	Each	27348	4047504
19	<b>R3-HE-6-2</b>				
	Providing and fixing CI Mechanical joint ALL Socket Tees, (dimensionally described in Table - 18 of IS :13382 / 1992) inclusive of Sealing Rubber Gasket of SBR (dimensionally described in IS : 12820),Cast Iron Follower Gland and Mild Steel Nut Bolts zinc coated or otherwise protected from rusting and suitable for CI/DI pipes etc complete as directed by Engineer in Charge				
	d) 150 x 150 x 80 mm dia	14.00	Each	5076	71064
	e) 150 x 150 x 100 mm dia	14.00	Each	5350	74900
	f) 150 x 150 x 150 mm dia	14.00	Each	6279	87906
	k) 250 x 250 x 80 mm dia	9.00	Each	9722	87498
	l) 250 x 250 x 100 mm dia	9.00	Each	9791	88119
	m) 250 x 250 x 150 mm dia	9.00	Each	10327	92943
	o) 250 x 250 x 250 mm dia	7.00	Each	12229	85603
	p) 300 x 300 x 80 mm dia	7.00	Each	12800	89600
	q) 300 x 300 x 100 mm dia.	7.00	Each	13023	91161
	r) 300 x 300 x 150 mm dia.	7.00	Each	14403	100821
	t) 300 x 300 x 250 mm dia.	7.00	Each	16827	117789
	u) 300 x 300 x 300 mm dia.	7.00	Each	19016	133112
20	<b>R3-HE-6-5</b>				
	Providing and fixing Mechanical Joint CI Flanged Socket Tail pieces, (described in Table - II of IS :13382 / 1992) inclusive of Sealing Rubber Gasket of SBR (dimensionally described in IS : 12820), rubber ring for flange joint, Cast Iron Follower Gland and Mild Steel Nut Bolts zinc coated or otherwise protected from rusting and suitable for CI/DI pipes etc complete as di-				

	rected by Engineer in Charge				
	a) 80 mm dia.	148.00	Each	2782	411736
21	<b>R3-HE-4-3</b>				
	<b>Making connection on live CI/DI water main of various sizes, including cutting of pipes with cutting machine, providing &amp; fixing, DI pipe upto 1 M. length of branch pipe, specials such as saddles, bends, distance pieces, flanges, collars etc. (suitable for lead joint), jointing the pipes with lead joint and pumping out body water etc complete in all respect as directed by Engineer in Charge. Note : (1) The required excavation, shoring, encasement in cement concrete &amp; sluice valve will be paid separately under relevant items.</b>				
	a) 450 mm x 80 mm	4.00	Each	19337	77348
	b) 450 mm x 100 mm	4.00	Each	21227	84908
	c) 450 mm x 150 mm	6.00	Each	26589	159534
	f) 600 mm x 150 mm	3.00	Each	26693	80079
	g) 600 mm x 250 mm	3.00	Each	39603	118809
	j) 750 mm x 150 mm	2.00	Each	33015	66030
	l) 750 mm x 300 mm	2.00	Each	55360	110720
	o) 900 mm x 150 mm	2.00	Each	40232	80464
	p) 900 mm x 250 mm	2.00	Each	53760	107520
	q) 900 mm x 300 mm	2.00	Each	61268	122536
22	<b>R3-HE-4-4</b>				

	<b>Making connection on live CI/DI water main of various sizes, including cutting of pipes with cutting machine, providing &amp; fixing DI pipe upto 1 M. length, specials such as tees, bends, distance pieces, flanges, collars etc. (suitable for lead joint), jointing the pipes with lead joint and pumping out body water etc complete in all respect as directed by Engineer in Charge. Note : (1) The required excavation, shoring, encasement in cement concrete &amp; sluice valve will be paid separately under relevant items. Note : (2) Rebate for salvation cost of old pipe has been considered and old pipes Shall be removed by the contractors as directed.</b>				
	a) 450 mm x 250 mm	6.00	Each	41490	248940
	c) 450 mm x 450 mm	2.00	Each	70267	140534
	d) 600 mm x 300 mm	3.00	Each	58926	176778
23	<b>R3-HE-4-1</b>				
	<b>Making connection on live CI/DI main of various sizes including cutting of pipes with pipe cutting machine, providing &amp; fixing, DI pipe upto 1 M. length of distance peice on live main , specials such as tee &amp; collar, jointing the pipes with mechanical joint as per IS 13382 / 1992 sealing with rubber gasket of SBR, with cast iron follower gland and mild steel zinc coated nut bolts suitable for CI/DI pipe, pumping out body water, etc complete in all respect as directed by Engineer in Charge Note : (1) The required excavation, shoring, encasement in cement concrete, any pipe/specials/sluice valve provided beyond Tee will be paid separately under relevant items. Note : (2) Rebate for salvation cost of old pipe has been considered and old pipes shall be removed by the contractors as directed.</b>				
	a) 80 mm x 80 mm	73.00	Each	7906.00	577138
	c) 100 mm x 100 mm	24.00	Each	8775.00	210600
	d) 150 mm x 80 mm	204.00	Each	10456	2133024
	e) 150 mm x 100 mm	67.00	Each	9108	610236
	f) 150 mm x 150 mm	138.00	Each	11658	1608804
	g) 250 mm x 80 mm	66.00	Each	17194	1134804
	h) 250 mm x 100 mm	26.00	Each	17263	448838
	i) 250 mm x 150 mm	59.00	Each	17797	1050023



	j) 250 mm x 250 mm	15.00	Each	19697	295455
	k) 300 mm x 80 mm	34.00	Each	22337	759458
	l) 300 mm x 100 mm	11.00	Each	22560	248160
	m) 300 mm x 150 mm	23.00	Each	23941	550643
	n) 300 mm x 250 mm	9.00	Each	26365	237285
	o) 300 mm x 300 mm	6.00	Each	28553	171318
24	<b>R3-HE-6-10</b>				
	<b>Providing &amp; fixing CI mechanical End Caps suitable for CI/DI pipes etc. complete with sealing rubber gaskets of SBR dimensionally described in IS : 12620/1989 and zinc coated MS nut bolts or otherwise protected from rusting and suitable for CI / DI pipes etc complete as directed by Engineer in Charge</b>				
	a) 80 mm dia.	63.00	Each	745	46935
	b) 100 mm dia.	56.00	Each	946	52976
	c) 150mm dia	81.00	Each	1303	105543
	d) 250 mm dia	25.00	Each	1966	49150
	e) 300 mm dia	20.00	Each	3022	60440
25	<b>R3-HE-3-30</b>				
	<b>Supplying, transporting on site and fixing Tamper proof Kinetic Air valves of PN 1.0 in Gray Cast Iron IS 210 FG 260 conforming to AWWA C-512 with sluice valves (double port) with nuts, bolts, washers etc.including making holes in the main and fixing saddle pieces,etc.complete. Note : Kinetic air valves with sluice valves (double port) and all other materials shall be supplied as per the acceptance criteria of MCGM as given in specification</b>				
	a) 50 mm dia	27.00	Each	38323	1034721
	b) 80 mm dia	21.00	Each	40600	852600
	c) 100 mm dia.	9.00	Each	48648	437832
26	<b>R3-HE-6-1</b>				

	<b>Providing and fixing CI Mechanical joint split collars suitable for repair of cracks/ leakages of CI/ DI pipes (Inclusive of Odd size pipes) as per MCGM specifications complete with sealing rubber gasket made of SBR and galvanized 'T' bolts and nuts. The whole assembly mechanically and Hydraulically tested to the provisions laid down in IS 1538/1993 or IS 13382/1992 whichever is applicable. This item includes dewatering of body water cleaning of pipe and arresting leakages etc complete as directed by Engineer in Charge</b>				
	a) 80 mm dia.	12.00	Each	5468	65616
	b) 100 mm dia	12.00	Each	7635	91620
	c) 150 mm dia	98.00	Each	10360	1015280
	e) 250 mm dia.	44.00	Each	16995	747780
	f) 300 mm dia	20.00	Each	26761	535220
	i) 450 mm dia.	3.00	Each	27644	82932
	k) 600 mm dia.	3.00	Each	36464	109392
	l) 750 mm dia.	3.00	Each	45549	136647
27	<b>R3-HE-10-1</b>				
	<b>Taking access opening on C.I./ D.I. Water main by machine cut ( 2m / 3m length) and reinstating the same by using mechanical joint collar and SBR rings, including dewatering of body water and subsoil water, etc. complete in all respect and as directed by the Engineer In Charge for following diameters of CI/DI water mains: In case pipe is damaged, replacement pipe to be paid as per item rate</b>				
	a) 150 mm dia.	51.00	Each	10854	553554
	b) 250 mm dia.	23.00	Each	13223	304129
	c) 300 mm dia.	13.00	Each	15241	198133
	d) 450 mm dia.	7.00	Each	28819	201733
	e) 600 mm dia.	3.00	Each	74504	223512
	f) 750 mm dia.	3.00	Each	116874	350622
	g) 900 mm dia.	3.00	Each	145050	435150
28	<b>R3-HE-4-7</b>				

	<b>Discarding the existing live CI/DI water main by plugging the same including cost of pipes and specials, Supplying, loading, transporting on site, unloading, lowering in trenches, assembling the CI / MS pipes / specials of required diameter, etc. complete including cost of mechanical cap or and with spun yarn and molten lead including caulking etc complete in all respect as directed by Engineer in Charge &amp; including cost of lead for following diameters. The cost of item is for plugging the water main on either side at one location. Note : (1) The required excavation, shoring, encasement in cement cement concrete &amp; sluice valve will be paid separately under relevant items. Note : (2) Rebate for salvation cost of old pipe has been considered and old pipes Shall be removed by the contractors as directed.</b>				
	a) 80 mm dia.	12.00	Each	5808	69696
	b) 100 mm dia.	21.00	Each	6065	127365
	c) 150 mm dia.	240.00	Each	6167	1480080
	d) 250 mm dia.	96.00	Each	6886	661056
	e) 300 mm dia.	33.00	Each	7762	256146
29	<b>R3-HE-1-16</b>				
	<b>Make lead and spun yarn joints for following nominal dia C.I. S&amp;S pipes and specials including supply of jointing materials (refined pig lead and spun yarn) caulking and testing of joints etc complete in all respect and as directed by Engineer in Charge</b>				
	a) 80 mm dia.	18.00	Each	728	13104
	b) 100 mm dia.	35.00	Each	836	29260
	c) 150 mm dia	325.00	Each	1071	348075
	d) 250 mm dia	81.00	Each	1639	132759
	e) 300 mm dia.	26.00	Each	1897	49322
30	<b>R3-HE-2-7</b>				
	<b>Fabricating,Supplying &amp; transporting M.S. material of required thickness such as blank flanges, loose flanges, rings, saddle pieces, small pieces to form saddle pieces, collars, clamp collars, bends/tees of various sizes etc. as per item.</b>				
	Lump sum provision	4025.00	Kg	76	305900
31	<b>R3-HE-8-4</b>				

	Providing and laying 200 mm thick hand sets dry rubble soling including filling the interstices with small chips, ramming etc. complete for foundations of pedestals, chairs, thrust blocks, etc. complete in all respect and as directed by Engineer In Charge.				
		5152.00	Sqm	319	1643488
32	<b>R3-CS-CW-1-b</b>				
	Providing and laying in position plain cement concrete of specified grade cement with trap/granite/quartzite/gneiss metal mixing in concrete mixer including bailing out water, compacting, finishing surface, curing and including the cost of centering and shuttering at all level : Nominal Mix of 1:2:4 (1 cement OPC: 2 coarse sand : 4 graded stone aggregate 20 mm nominal size)				
		1383.00	Cum	7232	10001856
33	<b>R3-CS-CW-1-a</b>				
	Providing and laying in position plain cement concrete of specified grade cement with trap/granite/quartzite/gneiss metal mixing in concrete mixer including bailing out water, compacting, finishing surface, curing and including the cost of centering and shuttering at all level : Nominal Mix of 1:1.5:3 (1 cement OPC: 1.5 coarse sand : 3 graded stone aggregate 20 mm nominal size)				
		866.00	Cum	7467	6466422
34	<b>R3-CS-MW-1-b</b>				
	Brick work with common burnt clay F.P.S. (non modular) bricks of class designation 3.5 and above in foundation and plinth in: Cement mortar 1:4 (1 cement : 4 coarse sand) etc. as per item.				
		1674.00	Cum	9257	15496218
35	<b>R3-SE-4-3</b>				
	Providing plaster 20mm thick 1:2 C.M. etc. as per item				
		5055.00	Sqm	433	2188815

36	<b>R3-SE-4-5</b>				
	<b>Providing plaster 25mm thick 1:2 C.M etc. as per item.</b>				
		9443.00	Sqm	588	5552484
37	<b>R3-HE-2-16</b>				
	<b>Providing and fixing MS frame and cover with its complete assembly including supply and fixing of the same etc complete for sluice valve, butterfly valves and kinetic air valves chambers as directed and as specified by Engineer In charge. The MS plate used for the cover shall be 20 mm thick. The new MS cover shall have anti skid arrangement. The anti skid arrangement shall be provided of 4mm thick MS flats of specified mm width and 300 mm center to center by continuous lap welding. \Following are the Standard weights of MS frame and cover with its complete assembly with anti skid arrangement. NOTE: Tolerance of +/- 5% of mentioned standard weights acceptable.</b>				
		197702.00	Rs/kg	86	17002372
38	<b>R3-HE-2-17</b>				
	<b>Removing of existing MS frame and cover and replacing it with new MS frame and cover with its complete assembly including supply and fixing of the same etc complete as directed and specified by Engineer In charge. The MS plate used for the cover shall be 20 mm thick. The new MS cover shall have anti skid arrangement. The anti skid arrangement shall be provided by welding 4mm thick MS flats of specified width and 300 mm center to center. Note : (1) Rebate for old removed MS frame and cover is considered in this item. (2) Tolerance of +/- 5% of mentioned standard weights shall be acceptable.</b>				
		42415.00	Rs/kg	62	2629730
39	<b>R3-HE-7-4</b>				

	<b>The transfer of existing service connections include cutting the existing connections, plugging the holes, supplying &amp; fixing new Gun metal ferrules, required GI fittings(heavy) supplying &amp; fixing new 'C' class G.I.pipes up to 1 meter length and and making the hole with hand tools, including necessary barracading,excavation in all type of Strata, and backfilling etc complete in all respect as directed by Engineer in Charge . Note : (1) The old pipes, ferrules &amp; fittings removed from site will be property of contractor &amp; shall be removed by the contractors as</b>				
	a) 15 mm	1233.00	Each	3304	4073832
	b) 20 mm	3754.00	Each	3476	13048904
	c) 25 mm	1449.00	Each	3773	5467077
	d) 32 mm	267.00	Each	5015	1339005
	e) 40 mm	141.00	Each	5664	798624
	f) 50 mm	141.00	Each	6886	970926
	g) 65 mm	33.00	Each	8680	286440
40	<b>R3-HE-7-2</b>				
	<b>Supplying, providing laying and jointing GI pipes including all required fittings in trenches of following class and diameter by wrapping them by hessian cloth with tar coating and including any nominal pipe length required to be laid above ground level, conveyance from stores to site work, all labour, necessary excavation in all type of Strata , backfilling, giving satisfactory hydraulic test, etc complete in all respect as directed by Engineer in Charge. Note : Only GI pipe brands from the MCGM approved vendor list shall be used, all pipe and pipe fittings shall be C class (heavy grade) having ISI marking.</b>				
	a) 15 mm	2466.00	Mtr	228	562248
	b) 20 mm	7508.00	Mtr	264	1982112
	c) 25 mm	2898.00	Mtr	348	1008504
	d) 32 mm	534.00	Mtr	408	217872
	e) 40 mm	281.00	Mtr	511	143591
	f) 50 mm	281.00	Mtr	625	175625
	g) 65 mm	65.00	Mtr	858	55770
41	<b>R3-HE-7-24</b>				

	<b>Removing and Replacing of existing old/damaged Brass / Gun Metal Ferrule Conforming to IS 2692 except for jumper valve, which will be of either brass / gun metal or Polypropylene coated light weight brass jumper valve, inclusive of required excavation and backfilling etc complete in all respect and as directed by Engineer In-Charge. Note : (1) Rebate for salvation cost of old ferrule has been considered and old ferrule to be removed from site will be property of contractor &amp; shall be removed by the contractors as directed.</b>				
	a) 15 mm	3587.00	Each	1496	5366152
	b) 20 mm	3890.00	Each	1628	6332920
	c) 25 mm	3683.00	Each	1895	6979285
	d) 32 mm	2265.00	Each	2163	4899195
	e) 40 mm	1918.00	Each	2670	5121060
	f) 50 mm	1540.00	Each	3624	5580960
41	<b>R3-HE-7-25</b>				
	<b>Providing and fixing Brass / Gun Metal Ferrule Conforming to IS 2692 except for jumper valve, which will be of either Polypropylene or brass / gun metal jumper valve, inclusive of required excavation and backfilling etc complete in all respect and as directed by Engineer In-Charge.</b>				
	a) 15 mm	400.00	Each	1544	617600
	b) 20 mm	433.00	Each	1708	739564
	c) 25 mm	410.00	Each	2045	838450
	d) 32 mm	252.00	Each	2387	601524
	e) 40 mm	213.00	Each	2991	637083
	f) 50 mm	172.00	Each	4095	704340
42	<b>R3-HE-7-3</b>				
	<b>Removing and replacing existing GI pipes with new GI pipes including all required fittings in trenches of following class and diameter by wrapping them by hessian cloth with tar coating and including any nominal pipe length required to be laid above ground level, conveyance from stores to site work, all labour, necessary excavation in all type of Strata,</b>				
	Lumsum provision				
	a) 15 mm	11958.00	Mtr	165	1973070
	b) 20 mm	539.00	Mtr	183	98637
	c) 25 mm	891.00	Mtr	221	196911

	d) 32 mm	104.00	Mtr	244	25376
	e) 40 mm	594.00	Mtr	321	190674
	f) 50 mm	580.00	Mtr	356	206480
	g) 65 mm	856.00	Mtr	520	445120
43	<b>R3-HE-7-11</b>				
	<b>Providing and fixing GI plugs (heavy) of following diameters etc complete in all respect etc complete in all respect as directed by Engineer in Charge. Note : Only MCGM approved GI pipe brands shall be used.</b>				
	a) 15 mm	81.00	Each	51	4131
	b) 20 mm	81.00	Each	61	4941
	c) 25 mm	81.00	Each	73	5913
	d) 32 mm	23.00	Each	97	2231
	e) 40 mm	18.00	Each	122	2196
	f) 50 mm	18.00	Each	135	2430
	g) 65 mm	18.00	Each	189	3402
44	<b>R3-HE-9-54</b>				
	<b>Cost of making hole of any size to suit 15 mm dia. to 50 mm dia. ferrule for making service connections on CI water main, including making the hole with Raichid machine &amp; making threads for providing ferrule etc. complete.</b>				
		345.00	Each	986	340170
45	<b>R3-HE-10-6</b>				
	<b>Hire charges for supplying &amp; providing C.C.T.V. camera (including monitor, Video/CD recorder, battery backup, accessories all enclosed in a waterproof enclosure) for inspection of water mains of any diameter at any location of the site including all required machinery, accessories, operators,etc. with all necessary backup recorded on CD's (3sets), excluding all taxes, etc complete in all respect and as directed by the Engineer In Charge</b>				
	Lump sum provision for unforeseen works if any	98.00	Each	8500	833000
46	<b>R3-RW-2-21</b>				



	Providing & laying, spreading & compacting specified crushed stone in granular subbase course including premixing the material in mechanical mixer (pug mill or approved type), spreading of mixed material in uniform layer of 100 mm to 75 mm (compacted thickness each) with motor grader or paver on prepared murum surface & compacting with 10 tonne vibratory roller to achieve desired density including all material, labour, machinery, lighting, barricading to all lifts & lead, maintenance of diversion etc. complete (metal gradation from 75mm to 75 micron as per prevailing MCGM specifications for Roadworks clause no.210).				
		391.00	Cum	2702	1056482
47	<b>R3-RW-2-20</b>				
	Providing & laying, spreading & compacting graded crushed stone aggregate to wet mix macadam to the satisfaction of Engineer including premixing the material with water to OMC in mechanical mix (pug mill) carriage of mix material by tipper to site, laying in uniform layer of 75 mm to 100 mm (compacted thickness each) with sensor paver finisher on prepared subbase & compacting with vibratory roller (10 tonne) to achieve desired density including lighting, guarding barricading & maintenance of diversion etc. as directed by the Engineer etc.				
		850.00	Cum	3338	2837300
48	<b>R3-RW-5-19</b>				

	Providing and applying <b>PRIME COAT</b> with <b>CATIONIC BITUMEN EMULSION (SS) @ 7 to 12 Kg. of 10Sqmt.</b> over prepared surface to receive bituminous mix by applying <b>PRIMER</b> with mechanical spray bitumen, including cleaning of road surface etc. completed, as directed For <b>Low Porosity surface &amp; the primed surface shall be allowed to cure for at least 24 hours or any other higher period, as is found to be necessary to allow all the moisture or volatiles to evaporate before any subsequent bituminous surface treatment or mix is laid (As per prevailing MCGM specification for Roadwork Clause No. 313, curing as per 313.5)</b>				
		3059.00	Sqm	79	241661
49	<b>R3-RW-5-22</b>				
	Providing and applying <b>TACK COAT</b> with <b>CATIONIC BITUMEN EMULSION (RS) @ 0.2 to 0.25 Kg. of Sq.mt.</b> over prepared surface to receive bituminous mix by applying <b>TACK COAT</b> with mechanical spray bitumen, including cleaning of road surface etc. completed, as directed For <b>NORMAL BITUMINOUS SURFACES &amp; the tack coat shall be left to cure until all the volatiles have evaporated before any subsequent construction is started, which is indicated by change in colour from brown to black (As per prevailing MCGM specification for Roadwork Clause No. 314, curing as per 314.3.4)</b>				
		3059.00	Sqm	39	119301
50	<b>R3-RW-5-04</b>				
	<b>P/L MINIMUM 30 mm hot Premix Bituminous concrete with 6.00% of VG-30 grade bitumen using new material,etc.</b>				
		3059.00	Sqm	579	1771161
51	<b>R3-RW-5-23</b>				

	Providing and applying TACK COAT with CATIONIC BITUMEN EMULSION (RS) @ 0.25 to 0.30 Kg. of Sq.mt. over prepared surface to receive bituminous mix by applying TACK COAT with mechanical spray bitumen, including cleaning of road surface etc. completed, as directed For DRY & HUNGRY BITUMINOUS SURFACES (As per prevailing MCGM specification for Roadwork Clause No. 314)				
		3059.00	Sqm	41	125419
52	<b>R3-RW-5-70</b>				
	P/L premix hot mix Bituminous concrete with 6.00% of VG-30 + waste plastic (the waste plastic to be used shall be as per the types of plastics given in IRC:SP:98-2013 & shall be in the proportion of 8 % by weight of bitumen) bitumen content by weight of mix surface coat to compacted thickness of 40 mm. using new material to the required grade, level and camber rolling with vibratory roller , power roller,pnumatic roller & using sensor paver etc. complete as specified and as directed with addition of lime filler 2% by weight of mix and anti stripping agent @ 1% of bitumen etc.(As per prevailing MCGM specification for Roadwork Clause No. 364)				
		1530.00	Sqm	761	1164330
53	<b>R3-RW-5-30</b>				
	P/L Mastic Asphalt 25 mm. thick having bitumen content 10% by weight as per I.S. code No. 5317/2002.(As per prevailing MCGM specification for Roadwork Clause No. 365)				
		1530.00	Sqm	1439	2201670
54	<b>R3-RW-5-13</b>				
	Supplying & laying of BITUMINOUS COLD MIXES work by using new material Rolling with power roller, vibratory roller & using sensor paver. ( CUTBACK BITUMEN Grade-MC) As per Mix design Morth 5th Revision April 2013 & as per prevailing MCGM specification for Roadwork Clause no.317				
		322.00	Cum	23346	7517412

55	<b>R3-RW-10-29</b>				
	Providing & laying M-40 C.C.avg. compressive strength (As per IRC 15-2002.N.1.6) procured from M.C.G.M. approved R.M.C. plant including use of approved make of plasticizer/ retarder & Contractor's water with ice flakes and transported by transit mixer and placing at work site. Compacting, finishing, initial curing by approved curing compound & Contractor's water and tarring the sides of slab with hot bitumen as specified and directed (w/c ratio 0.4 maximum)(vata for curring will be paid separately.) (MINIMUM CEMENT CONTENT 350 kg/m3)				
		925.00	Cum	7962	7364850
56	<b>R3-RW-10-7</b>				
	Cutting of construction & dummy joints of M-35 C.C.& above slab by mechanical means within 10 to 16 hrs of casting of bay/ slab as directed. A) transverse dummy joints 100 mm deep or 1/3 thickness of concrete pavement & 6 mm wide.				
		1369.00	Rmt	84	114996
57	<b>R3-RW-10-8</b>				
	Cutting of construction & dummy joints of M-35 C.C.& above slab by mechanical means within 10 to 16 hrs of casting of bay/ slab as directed. B) Longitudinal construction joints 100mm deep or 1/3rd thickness of slab & 6 mm wide				
		1760.00	Rmt	84	147840
58	<b>R3-RW-10-10</b>				
	providing and placing 5mm thick thermocol in dummy & construction joints immediately after cutting joints & removing the same before dressing of dummy & construction joints etc.				
		313.00	Sq.m	88	27544
59	<b>R3-RW-10-14</b>				
	Providing & laying waterproof paper of 40 GSM including overlap ( to be not less than 10cm) etc. complete as specified as directed.				
		3080.00	Sqm	41	126280
60	<b>R3-RW-10-9</b>				

	Providing & fixing in position premoulded asphalt filler 12 mm thick conforming to I.S. 1838 of 1983 for placing of the expansion joint, around manholes & water entrances, etc. put to the required depth & 25 mm below the camber, etc. complete as directed.				
		313.00	Sqm	364	113932
61	<b>R3-RW-10-23</b>				
	P/L R.M.C. M-10 C.C. in foundation/ encasement/ pavement with or without chequered design including formwork, mixing in batching plant, placing, vibrating with plate or needle vibrator, curing etc. complete as directed by the Engineer. Contractors has to make his own arrangement of water for curing with Hessian cloth etc. & will not be paid separately. (MINIMUM CEMENT CONTENT 220 Kg/m3.)				
		393.00	Cum	5703	2241279
62	<b>R3-RW-3-19</b>				
	Providing & fixing in the carriageway 100 mm SQM thick interlocking concrete unishape pavers (monolithic- single layer pre-cast concrete blocks)of grey cement coloured having average crushing strength not less than 50 N/mm2 as per technical specification and IS CODE 15658:2006, placedon average compacted thickness of 25 mm wellgraded sand cushioning uniformly compactedwith proper capacity mechanical compactor with required level, grade and camber etc. complete as specified and as directed by the Engineer.				
		35.00	Sqm	977	34195
63	<b>R3-RW-3-21</b>				

	<p><b>Removing &amp; refixing interlocking concrete pavers SQM of 100 mm thick, of any size, shape and colour considering 10% breakage area of paver block while removing same from position and replacing the same by new paver blocks having average crushing strength not less than 50 N/mm<sup>2</sup> as per technical specifications and IS CODE 15658:2006, placed on average compacted thickness of 25 mm well graded sand cushioning uniformly compacted with proper capacity mechanical compactor with required level, grade and camber etc. complete as specified and as directed by the Engineer.</b></p>				
		35.00	Sqm	271	9485
64	<b>R3-RW-3-27</b>				
	<p><b>Providing &amp; fixing in the footpath Concrete Paving Slabs (Flagstone) 400X400X60mm thick or any approved size in grey or any specified colour with shotblasted texture or any approved texture on top surface of approved pattern/shape etc.</b></p>				
	Lump sump qty	35.00	Sqm	873	30555
65	<b>R3-RW-3-43</b>				
	<p><b>Removing &amp; refixing interlocking Concrete Paving Slabs(Flagstone) 400X400X60mm thick in grey colour with shot blasted texture on top surface in various colour combination (RW-3.27) considering 10% breakage area of paver block while removing same from position and replacing the same by new paver blocks having average crushing strength not less than 40 N/mm<sup>2</sup> as per technical specification and IS code 15658:2006; placed on average compacted thickness 25 mm well graded sand cushioning uniformly compacted with proper capacity mechanical compactor with required level, grade and camber etc. complete as specified and as directed by the Engineer.</b></p>				
	Lump sump qty	35.00	Sqm	257	8995

66	<b>R3-RW-3-28</b>				
	Providing & fixing in the footpath Concrete Paver blocks 200 X200 X60 mm thick or any approved size in grey or any specified colour with shot blasted texture or any approved texture on top surface of approved pattern/ shape and colour having average crushing strength not less than 40 N/mm <sup>2</sup> as per technical specifications and IS CODE 15658:2006; manufactured in double layer precast concrete Paver blocks 12 to 15 mm thick in top layer and consisting of cubical shape Quartz stone aggregate 8 mm sieve 100% passing and retain on 4.75 mm size sieve, silica sand. The bottom layer should be 45 to 48 mm thick in grey cement having 12 mm sieve 100% passing aggregates as per technical specifications, rested on average compacted thickness 25 mm well graded sand cushioning uniformly compacted with proper capacity mechanical compactor with required level, grade and camber etc. complete as specified and as directed by the Engineer.				
		35.00	Sqm	718	25130
67	<b>R3-RW-3-44</b>				
	Removing & refixing interlocking concrete pavers of 60 mm thick of any size, shape and colour (Began it in grey/Black colour with Stone texture on top surface, 200X200X60mm thick in grey colour with shot blasted texture on top surface, Concrete cobbles 100X100X60mm thick in Grey colour with shot blasted texture on top surface,60 mm thick Heritage paver interlocking white cement concrete pavers in red ( Terra Cotta) Black, Brown lamen colour with vermeticular or any antiskid texture on top surface, Vitrified Ceramic Topping Paver Blocks of size 150 x 150 x 60mm thick in various colour combination,combi-paver 60 MM) etc.				
		35.00	Sqm	257	8995
68	<b>R3-RW-3-17</b>				

	Providing & fixing in the footpath, 60 mm thick Lacquer coated (Reflective) interlocking grey cement concrete pavers in Red ( Terra Cotta), Black, Brown, lemon yellow or any colour with vermeticular or any antiskid texture on top surface of approved pattern/ shape and colour having average crushing strength not less than 40 N/mm <sup>2</sup> manufactured in double layer precast concrete blocks as per technical specifications and IS CODE 15658:2006.				
		35.00	Sqm	706	24710
69	<b>R3-RW-3-14</b>				
	Removing & refixing interlocking concrete pavers of 60 mm thick, of any size, shape and colour considering 10% breakage area of paver block while removing same from position and replacing the same by new paver blocks having average crushing strength of not less than 40 N/mm <sup>2</sup> as per technical specifications and IS Code 15658:2006, placed on average compacted thickness of 25 mm well graded sand cushioning uniformly compacted with proper capacity mechanical compactor with required level, grade and camber etc. complete as specified and as directed by the Engineer.				
		35.00	Sqm	240	8400
70	<b>R3-RW-3-30</b>				
	Providing & fixing in the footpath Concrete cobbles 100 X100 X60 mm thick or in any approved size in Grey colour or in any specified R3-RW-3-31 colour with shot blasted texture or any approved texture on top surface of approved pattern/ shape and colour having average crushing strength not less than 40 N/mm <sup>2</sup> as per technical specifications and IS CODE 15658:2006;				
		35.00	Sqm	833	29155
71	<b>R3-RW-10-25</b>				



	P/L R.M.C.M-20 C.C. procured from M.C.G.M. approved R.M.C. plant including use of approved makes of plasticizer/retarder & transported by transit mixer & placing at worksite, compacting, finishing curing etc. by contractor's water & tarring the sides of form work with hot bitumen as specified & directed by the Engineer. (MINIMUM CEMENT CONTENT 260 Kg/m3.)				
		125.00	Cum	6489	811125
72	<b>R3-RW-10-57</b>				
	Extra Over item of stencil concrete above M20 in footpath. Providing, applying and finishing the top surface of M-20 concrete with stamp/ stencil of approved pattern and colour, in accordance with manufacturer's specification of <b>R3-RW-10-58</b> any approved brand of colour hardener @ of 3.5 kgs/m <sup>2</sup> ; including floating of colour hardened over concrete surface with different types of floaters; including application of release agent @ of 0.15 kgs/m <sup>2</sup> , stamping over the concrete surface with stamping tools; including cleaning of surface with water and cutting of finished concrete; including application of two coats of acrylic based sealer for finishing. etc.				
		1811.00	Sqm	265	479915
73	<b>R3-SE-5-1</b>				
	P/L stoneware pipe of SP2 class including jointing with CM (1:1) etc as per items.				
	Lumpsum provision				
	a) 150mm s/w pipe	196.00	Mtr	680	133280
	b) 230mm s/w pipe	196.00	Mtr	1113	218148
	c) 300mm s/w pipe	196.00	Mtr	2013	394548
74	<b>R3-RW-8-01</b>				
	P/L 150 mm dia. R.C.C. hume pipes, NP2 class, MTR jointing, filling in 1:1 C.M., including plugging of both the ends with gunny bags, brick masonry in C.M. 1:4 with plaster in C.M. 1:4 & curing etc. complete, as specified as directed.				
	Lumpsum provision	196.00	Mtr	674	132104

75	<b>R3-RW-8-02</b>				
	P/L 250 mm dia. R.C.C. hume pipes, NP2 class, jointing, filling in 1:1 C.M., including plugging of both the ends with gunny bags, brick masonry in C.M. 1:4 with plaster in C.M. 1:4 & curing etc. complete, as specified as directed				
		196.00	Mtr	868	170128
76	<b>R3-RW-8-03</b>				
	P/L 300 mm dia. R.C.C. hume pipes, NP2 class, jointing, filling in 1:1 C.M., including plugging of both the ends with gunny bags, brick masonry in C.M. 1:4 with plaster in C.M. 1:4 & curing etc. complete, as specified as directed				
		196.00	Mtr	1033	202468
77	<b>R3-RW-4-01</b>				
	Providing & Fixing kerb stones 30 cm.to 40 cm. long., 15 cm. wide, 38 cm. deep medium dressed in all exposed surfaces, set in cement mortar 1:2 on a 15 cm. thick and 25 cm. wide RMC M-20 C.C. bed including filling the joints with 1:2 C.M. pointing, curing etc. complete.				
	Lumpsum provision	1716.00	Mtr	573	983268
78	<b>R3-RW-4-02</b>				
	Removing & resetting kerb stones in 1:2 C.M. on new R.M.C.M-20 C.C. bed 15 cm, thick including filling the joints with 1:2 C.M. pointing, curing etc. complete.				
		1716.00	Mtr	343	588588
79	<b>R3-RW-4-06</b>				
	Providing & fixing water tables of stone of size 30 cm. wide and 10 cm. thick, fairly dressed on a R.M.C. M-20 cement concrete bed 15 cm. thick, including filling in the joints, with cement mortar 1:2 cement pointing, curing etc. complete as specified and as directed by the Engineer.				
	Lumpsum provision	1716.00	Mtr	435	746460
80	<b>R3-RW-4-07</b>				

	Removing & resetting water tables 30 cm. wide on a new M-20 cement concrete bed 15 cm .thick including filling in the joints with C.M.1:2 and cement pointing , curing including removing the old cement bed, curing etc. complete. Removing existing water tables/cleani				
		1716.00	Mtr	381	653796
81	<b>R3-SWD-130</b>				
	Demolishing existing single or double water entrances, including cutting down of old brick masonry and concrete, removing of all serviceable material such as grating, runner beams, purdis etc.and handing over the same to nearest Municipal depot etc.complete as directed by Engineer-in-Charge..				
	Lump sum provision	458.00	Each	1084	496472
82	<b>R3-SWD-129</b>				
	Shifting & reconstructing single water entrance in BM 1:4, 12 mm thick internal plaster in C.M. 1:2, utilising existing frame, gratings, R.C.C. runners, beams, purdis and dhapas (without excavation and refilling) including breaking old masonry, blocking the openings of old connection, including bed concrete in M-15, copping in M-20, fixing the frames & covers in M-20, etc., complete e as specified and as directed by Engineer-in-Charge.				
	Lump sum provision	186.00	Each	14310	2661660
83	<b>R3-SWD-141</b>				
	Constructing double water entrance of internal size 0.60m x 1.20m with cast-in-situ coping in M-20 grade, fixing gratings in M-20 as per standard drawings (Dwg No. MCGM/SWD/2013-13), etc complete as specified and as directed by Engineer-in-Charge. (excluding excavation, providing and fixing of gratings and frame)				
	Lump sum provision	179.00	Each	16116	2884764
84	<b>R3-SWD-142</b>				

	Constructing single water entrance of internal size 0.50m x 0.60m with cast-in-situ coping in M-20 grade, fixing of grating in M -20 as per standard drawings (Dwg No. MCGM/SWD/2013-14), etc complete as specified and as directed by Engineer-in-Charge. (excluding excavation, providing and fixing of gratings and frame)				
	Lump sum provision	95.00	Each	10918	1037210
85	<b>R3-SWD-143</b>				
	Constructing single water entrance of internal size 0.45m x 0.45m with cast-in-situ coping in M-20 grade, fixing of grating in M -20 as per standard drawings (Dwg No. MCGM/SWD/2013-11), etc complete as specified and as directed by Engineer-in-Charge. (excluding excavation, providing and fixing of gratings and frame)				
	Lump sum provision	186.00	Each	9905	1842330
86	<b>R3-SWD-148</b>				
	Supplying and fixing 0.90m x 0.60m internal size of rectangular C.I. air-tight cover and frame etc. as per item.				
	Lump sum provision	15.00	Each	33841	507615
87	<b>R3-SWD-169</b>				
	Providing & Fixing 0.60m X 0.50m clear internal size of M.S. Galvanised hinged type grating and frame (weighing minimum 71 kg) with minimum 75 microns zinc coating by hot dipped galvanising the MS grating and frame as per IS 2629. (The contractor shall furnish the certificate of galvanising from the Galvaniser.) including testing ,inspection of material sample and				
		95.00	Each	11934	1133730
88	<b>R3-SWD-168</b>				

	Providing & Fixing 0.45m X 0.45m clear internal size of M.S. Galvanised hinged type grating and frame (weighing minimum 53 kg) with minimum 75 microns zinc coating by hot dipped galvanising the MS grating and frame as per IS 2629. (The contractor shall furnish the certificate of galvanising from the Galvaniser.) including testing ,inspection of material sample and finished product in presence of M.C.G.M. Engineers (3 nos.) at Manufacturer's works, as per Standard Specification no SP-SWD-2 and as per drawing (Dwg No. MCGM/SWD/2013-08), etc complete as specified & as directed by Engineer-in-Charge.				
		186.00	Each	9019	1677534
89	<b>R3-SWD-176-A</b>				
	Providing & Fixing 1.20m X 0.60m clear internal size of M.S. Galvanised hinged type grating and frame (weighing minimum 130 kg) of grade HD20, with minimum 75 microns zinc coating by hot dipped galvanising the MS grating and frame as per IS 2629. (The contractor shall furnish the certificate of galvanising from the Galvaniser.) including testing ,inspection of material sample and finished product as per IS standards and as per Standard Specification no SP-SWD-3 and as per standard drawing , etc complete as specified & as directed by Engineer- in-Charge				
		91.00	Each	20958	1907178
90	<b>R3-HE-3-26</b>				
	upplying, loading, transporting on site, unloading flange adaptors of PN 1.0 conforming AWWA C-219 with appurtenances, nuts, bolts, washers, packings etc. stacking the same as directed on site, hoisting, lowering and positioning the same in true plumb and level with tappers, saddles, branches flanges etc. on CI / DI or MS water mains and for PE pipes				
	a)300mm	64.00	Each	54054	3459456
91	<b>R3-RW-10-24</b>				

	<b>Supply &amp; filling sand metal, GRAVELLY SAND, corresponded to CLASS II/ CLASS III GRADING</b>	3188.00	Each	2251.00	7176188
				<b>total</b>	₹ <b>33,55,41,977.00</b>

**This page is intentionally kept Blank**

**This page is intentionally kept Blank**



**This page is intentionally kept Blank**

**This page is intentionally kept Blank**

**This page is intentionally kept Blank**

**This page is intentionally kept Blank**

**This page is intentionally kept Blank**

**This page is intentionally kept Blank**

**SECTION 9  
GENERAL CONDITIONS OF  
CONTRACT**

## General Conditions of Contract

### A. General

#### 1. Definitions

1.1. Terms which are defined in the Contract Data are not also defined in the Conditions of Contract but keep their defined meanings. Capital initials are used to identify defined terms.

**The “Contract”** shall mean the tender and acceptance thereof and the formal agreement if any, executed between the Contractor, Commissioner and the Corporation together with the documents referred to therein including these conditions and appendices and any special conditions, the specifications, designs, drawings, price schedules, bills of quantities and schedule of rates. All these documents taken together shall be deemed to form one Contract and shall be complementary to one another.

**The Contract Data** defines the documents and other information which comprise the Contract.

**The “Contractor”** shall mean the individual or firm or company whether incorporated or not, whose tender has been accepted by the employer and the legal successor of the individual or firm or company, but not (except with the consent of the Employer) any assignee of such person.

**The Bidder** is a person or corporate body who has desired to submit Bid to carry out the Works, including routine maintenance till the tender process is concluded.

**The Contractor's Bid** is the completed bidding document submitted by the Contractor to the Employer.

**The “Contract Sum”** means the sum named in the letter of acceptance including Physical contingencies subject to such addition thereto or deduction there-from as may be made under the provisions hereinafter contained.

Note : The contract sum shall include the following –

- In the case of percentage rate contracts the estimated value of works as mentioned in the tender adjusted by the Contractor’s percentage.
- In the case of item rate contracts, the cost of the work arrived at after finalization of the quantities shown in schedule of items / quantities by the item rates quoted by the tenderers for various items and summation of the extended cost of each item.
- In case of lumpsum contract, the sum for which tender is accepted.
- Special discount / rebate / trade discount offered by the tenderer if any and accepted by the Corporation.
- Additions or deletions that are accepted after opening of the tenders.



**The “Contract Cost”** means the Contract Sum plus Price Variation. This cost shall be included in the letter of acceptance.

**A Defect** is any part of the Works not completed in accordance with the Contract.

**The Defects Liability Certificate** is the certificate issued by the Engineer, after the Defect Liability Period has ended and upon correction of Defects by the Contractor.

Drawings means all the drawings, calculations and technical information of a like nature provided by the Engineer to the Contractor under the Contract and all drawings, calculations, samples, patterns, models, operation & maintenance manual and other technical information of like nature submitted by the Contractor and approved by the Engineer.

**The Authority** shall mean Brihanmumbai Municipal Corporation (BMC)

**The “Employer”** shall mean the Brihanmumbai Municipal Corporation (BMC) / Municipal Commissioner for Greater Mumbai, for the time being holding the said office and also his successors and shall also include all “Additional Municipal Commissioners, Director (Engineering Services & Projects)” and the Deputy Municipal Commissioner, to whom the powers of Municipal Commissioner, have been deputed under Section 56 and 56B of the Mumbai Municipal Corporation Act.

**The Engineer in-charge** shall mean the Executive Engineer in executive charge of the works and shall include the superior officers of the Engineering department i.e. Dy.Ch.Eng/Ch.Eng. and shall mean and include all the successors in BMC

**The Engineer's Representative** shall mean the Assistant Engineer, Sub. Engineer/Jr. Engineer in direct charge of the works and shall include Sub Eng./ Jr. Eng of Civil section/ Mechanical section/ Electrical section appointed by BMC.

**The “Engineer”** shall mean the City Engineer / the Hydraulic Engineer / the Chief Engineer / the Special Engineer, appointed for the time being or any other officer or officers of the Municipal Corporation who may be authorized by the commissioner to carry out the functions of the City Engineer / the Hydraulic Engineer / the Chief Engineer / the Special Engineer or any other competent person appointed by the employer and notified in writing to the Contractor to act in replacement of the Engineer from time to time.

**Contractor’s Equipment** means all appliances and things of whatsoever nature required for the execution and completions of the Works and the remedying of any defects therein, but does not include plant material or other things intended to form or forming part of the Permanent Works.

**The Initial Contract Price** is the Contract Price listed in the Employer's Letter of Acceptance.

**The Intended Completion Date** is the date on which it is intended that the Contractor shall complete the construction works. The Intended Completion Date is specified in the Contract Data. The Intended Completion Date may be revised only by the Engineer by issuing an extension of time.

**Materials** are all supplies, including consumables, used by the Contractor for incorporation in the Works and works of routine maintenance.

**Plant** is any integral part of the Works that shall have a mechanical, electrical, electronic, chemical, or biological function.

**Routine Maintenance** is the maintenance of activities of the completed structure for five years as specified in the Contract Data.

**The “Site”** shall mean the land and other places including water bodies more specifically mentioned in the special conditions of the tender, on, under in or through which the permanent works or temporary works are to be executed and any other lands and places provided by the Municipal Corporation for working space or any other purpose as may be specifically designated in the contract as forming part of the site.

**Site Investigation Reports** are those that were included in the bidding documents and are reports about the surface and subsurface conditions at the Site.

**“Specification”** shall mean the specification referred to in the tender and any modification thereof or addition or deduction thereto as may from time to time be furnished or approved in writing by the Engineer.

**The Start Date/Commencement Date** is given in the Contract Data. It is the date when the Contractor shall commence execution of the Works. It does not necessarily coincide with any of the Site Possession Dates.

**A Nominated Sub-Contractor** is a person or corporate body who has a Contract with the Contractor to carry out a part of the construction work and/or routine maintenance in the Contract, which includes work on the Site.

**Temporary Works** are works designed, constructed, installed, and removed by the Contractor that are needed for construction or installation of the Works.

**Variation** means a change to the:-

- i) Specification and /or Drawings (if any) which is instructed by the Employer.
- ii) Scope in the Contract which is instructed by the Employer.
- iii) Price in the Contract which is instructed by the Employer.

**The Works**, as defined in the Contract Data, are what the Contract requires the Contractor to construct, install, maintain, and turn over to the Employer. Routine maintenance is defined separately.

**Jurisdiction:** In case of any claim, dispute or difference arising in respect of a contract, the cause of action thereof shall be deemed to have arisen in Mumbai and all legal proceedings in respect of any claim, dispute or difference shall be instituted in a competent court in the City of Mumbai only.

## **2. Interpretation**

- 2.1. In interpreting these Conditions of Contract, singular also means plural, male also means female or neuter, and the other way around. Headings have no significance. Words have their normal meaning under the language of the Contract unless specifically defined. The Engineer will provide instructions clarifying queries about these Conditions of Contract.
- 2.2. If sectional completion is specified in the Contract Data, references in the Conditions of Contract to the Works, the Completion Date, and the Intended Completion Date apply to any Section of the Works (other than references to the Completion Date and Intended Completion Date for the whole of the Works).
- 2.3. The documents forming the Contract shall be interpreted in the following documents: (1) Agreement, (2) Letter of Acceptance, (3) Notice to Proceed with the Work , (4) Contractor's Bid, (5) Contract Data, (6) Special Conditions of Contract Part (7) General Conditions of Contract Part I, (8) Specifications, (9) Drawings, (10) Bill of Quantities, and (11) Any other document listed in the Contract Data.

## **3. Engineer's Decisions**

- 3.1. Except where otherwise specifically stated, the Engineer will decide contractual matters between the Employer and the Contractor in the role representing the Employer. However, if the Engineer is required under the rules and regulations and orders of the Employer to obtain prior approval of some other authorities for specific actions, he will so obtain the approval, before communicating his decision to the Contractor.
- 3.2. Except as expressly stated in the Contract, the Engineer shall not have any authority to relieve the Contractor of any of his obligations under the contract.

## **4. Delegation**

- 4.1. The Engineer, with the approval of the Employer, may delegate any of his duties and responsibilities to other person(s), except to the Adjudicator, after notifying the Contractor, and may cancel any delegation after notifying the Contractor.

## **5. Communications**

All certificates, notices or instructions to be given to the Contractor by Employer/ Engineer shall be sent on the address or contact details given by the Contractor of Bid. The address and contact details for communication with the Employer/ Engineer shall be as per the details given in Contract Data. Communications between parties that are referred to in the conditions shall be in writing. The Notice sent by facsimile (fax) or other electronic means shall be effective on confirmation of the transmission. The Notice sent by Registered post or Speed post shall be effective on delivery or at the expiry of the normal delivery period as undertaken by the postal service.

## 6. Subcontracting

6.1. Unless specifically mentioned in the contract subletting will not be allowed. Subletting, where otherwise provided by the contract shall not be more than 25% of the contract price. The subletting is allowed with the approval of Hydraulic Engineer.

6.2. The Contractor shall not be required to obtain any consent from the Employer for:

- a. The sub-contracting of any part of the Works for which the Subcontractor is named in the Contract;
- b. The provision for labour, or labour component.
- c. The purchase of Materials which are in accordance with the standards specified in the Contract.

6.3. Beyond what has been stated in clauses 6.1 and 6.2, if the Contractor proposes sub contracting any part of the work during execution of the Works, because of some unforeseen circumstances to enable him to complete the Works as per terms of the Contract, the Employer will consider the following before according approval:

- a. The Contractor shall not sub-contract the whole of the Works.
- b. The permitted subletting of work by the Contractor shall not establish any contractual relationship between the sub-contractor and the BMC and shall not relieve the Contractor of any responsibility under the Contract.

6.4. The Engineer should satisfy himself before recommending to the Employer whether

- a. The circumstances warrant such sub-contracting; and
- b. The sub-Contractor so proposed for the Work possesses the experience, qualifications and equipment necessary for the job proposed to be entrusted to him.

## 7. Other Contractors

7.1. The Contractor shall cooperate and share the Site with other Contractors, public authorities, utilities, and the Employer between the dates given in the Schedule of Other Contractors, as referred to in the Contract Data. The Contractor shall also provide facilities and services for them as described in the Schedule. The Employer may modify the Schedule of Other Contractors, and shall notify the Contractor of any such modification.

7.2. The Contractor should take up the works in convenient reaches as decided by the Engineer to ensure there is least hindrance to the smooth flow and safety of traffic including movement of vehicles and equipment of other Contractors till the completion of the Works.

## 8. Personnel

8.1. The Contractor shall employ for the construction work and routine maintenance the key personnel including technical personnel named in the Contract Data or other personnel approved by the Engineer. The Engineer will approve any proposed replacement of technical personnel only if their

relevant qualifications and abilities are substantially equal to those of the personnel stated in the Contract Data.

8.2. The Contractor's personnel shall appropriately be qualified, skilled and experienced in their respective trades or occupations. The Engineer shall have authority to remove, or cause to be removed, any person employed on the site or works, who carries out duties incompetently or negligently and persists in any conduct which is prejudicial to safety, health or the protection of the environment.

8.3. If the Engineer asks the Contractor to remove a person who is a member of the Contractor's staff or work force, stating the reasons, the Contractor shall ensure that the person leaves the Site within seven days and has no further connection with the Works in the Contract.

8.4. The Contractor shall not employ any retired Gazetted officer who has worked in the Engineering Department of the BMC /State Government and has either not completed two years after the date of retirement or has not obtained BMC/State Government's permission to employment with the Contractor.

## **9. Employer's and Contractor's Risks**

9.1. The Employer carries the risks which this Contract states are Employer's risks, and the Contractor carries the risks which this Contract states are Contractor's risks.

## **10. Employer's Risks**

10.1. The Employer is responsible for the excepted risks which are (a) in so far as they directly affect the execution of the Works in the Employer's country, the risks of war, invasion, act of foreign enemies, rebellion, revolution, insurrection or military or usurped power, civil war, riot, commotion or disorder (unless restricted to the Contractor's employees) and contamination from any nuclear fuel or nuclear waste or radioactive toxic explosive, or (b) a cause due solely to the design of the Works, other than the Contractor's design.

## **11. Contractor's Risks**

11.1. All risks of loss of or damage to physical property and of personal injury and death which arise during and in consequence of the performance of the Contract other than the excepted risks, referred to in clause 11.1, are the responsibility of the Contractor.

## **12. Insurance**

12.1. The Contractor at his cost shall provide, in the joint names of the Employer and the Contractor, insurance cover from the Start Date to the end of Defects Liability Period, in the amounts and deductibles stated in the Contract Data for the following events which are due to the Contractor's risks:

- a) Loss of or damage to the Works, Plant and Materials;
- b) Loss of or damage to Equipment;

- c) Loss of or damage to property (other than the Works, Plant, Materials, and Equipment) in connection with the Contract; and
- d) Personal injury or death.

12.2. Insurance policies and certificates for insurance shall be delivered by the Contractor to the Engineer for the Engineer's approval before the Start Date. All such insurance shall provide for compensation to be payable in the types and proportions of currencies required to rectify the loss or damage incurred.

12.3. Alterations to the terms of insurance shall not be made without the approval of the Engineer.

12.4. Both parties shall comply with any conditions of the insurance policies.

12.5. If the Contractor does not provide any of the policies and certificates required, the Employer may affect the insurance which the Contractor should have provided and recover the premiums the Employer has paid, from payments otherwise due to the Contractor or if no payment is due, the payment of premiums shall be debt due.

### **13. Site Investigation Reports**

13.1. The Contractor, in preparing the Bid, may rely, at his own risk, on any Site Investigation Reports referred to in the Contract Data, supplemented by any other information available to him, before submitting the bid.

### **14. Queries about the Contract Data**

14.1. The Engineer will clarify queries on the Contract Data.

### **15. Contractor to Construct the Works and Undertake Maintenance (if specified in the tender)**

15.1. The Contractor shall construct, and install and maintain the Works in accordance with the Specifications and Drawings and as per instructions of the Engineer.

15.2. The Contractor shall construct the works with intermediate technology, i.e., by manual means with medium input of machinery required to ensure the quality of works as per specifications. The Contractor shall deploy the equipment and machinery as required in the contract.

15.3. The Contractor shall take all reasonable steps to protect the environment on and off the Site and to avoid damage or nuisance to persons or to property of the public or others resulting from pollution, noise or other causes arising as a consequence of his methods of operation.

During continuance of the contract, the Contractor and his sub-contractors shall abide at all times by all existing enactments on environmental protection and rules made there under, regulations, notifications and byelaws of the State or Central Government, or local authorities and any other law, bye-law, regulations that may be passed or notification that may be issued in future by the State or Central Government or the local authority. Salient features of some of the major laws that are applicable are given below:

- The Water (Prevention and Control of Pollution) Act, 1974, this provides for the prevention and control of water pollution and the maintaining and restoring of wholesomeness of water. ‘Pollution’ means such contamination of water or such alteration of the physical, chemical or biological properties of water or such discharge of any sewage or trade effluent or of any other liquid, gaseous or solid substance into water (whether directly or indirectly) as may, or is likely to, create a nuisance or render such water harmful or injurious to public health or safety, or to domestic, commercial, industrial, agricultural or other legitimate uses, or to the life and health of animals or plants or of aquatic organisms.
- The Air (Prevention and Control of Pollution) Act, 1981, this provides for prevention, control and abatement of air pollution. ‘Air Pollution’ means the presence in the atmosphere of any ‘air pollutant’, which means any solid, liquid or gaseous substance (including noise) present in the atmosphere in such concentration as may be or tend to be injurious to human beings or other living creatures or plants or property or environment.
- The Environment (Protection) Act, 1986, this provides for the protection and improvement of environment and for matters connected therewith, and the prevention of hazards to human beings, other living creatures, plants and property. ‘Environment’ includes water, air and land and the inter-relationship which exists among and between water, air and land, and human beings, other living creatures, plants, micro-organism and property.
- The Public Liability Insurance Act, 1991, This provides for public liability insurance for the purpose of providing immediate relief to the persons affected by accident occurring while handling hazardous substances and for matters connected herewith or incidental thereto. Hazardous substance means any substance or preparation which is defined as hazardous substance under the Environment (Protection) Act 1986, and exceeding such quantity as may be specified by notification by the Central Government.

**16. The Works and Routine Maintenance to be completed by the Intended Completion Date**

- 16.1. The Contractor may commence execution of the Works on the Start Date and shall carry out the Works and Routine Maintenance, if specified in the tender, in accordance with the program submitted by the Contractor, as updated with the approval of the Engineer, and complete them by the Intended Completion Date.

**17. Approval by the Engineer**

- 17.1. The Contractor shall submit Specifications and Drawings showing the proposed Temporary Works to the Engineer, who is to approve them if they comply with the Specifications and Drawings.
- 17.2. The Contractor shall be responsible for design and safety of Temporary Works.
- 17.3. The Engineer's approval shall not alter the Contractor's responsibility for design and safety of the Temporary Works.

17.4. The Contractor shall obtain approval of third parties to the design of the Temporary Works, where required.

17.5. All Drawings prepared by the Contractor for the execution of the temporary or permanent Works, are subject to prior approval by the Engineer before their use.

17.6.

## 18. Safety

18.1. The Contractor shall be responsible for the safety of all activities on the Site. He shall comply with all applicable safety requirements and take care of safety of all persons entitled to be on the site and the works. He shall use reasonable efforts to keep the site and the works, both during construction and maintenance, clear of unnecessary obstruction so as to avoid danger to the persons and the users.

- Workers employed on mixing asphaltic materials, cement and lime mortars shall be provided with protective footwear and protective goggles.
- Stone breaker shall be provided with protective goggles and protective clothing and seated at sufficiently safe intervals.
- The area should be barricaded or cordoned off by suitable means to avoid mishaps of any kind. Power warning signs should be displayed for the safety of the public whenever cleaning works are undertaken during night or day.
- The workers engaged for cleaning the manholes/sewers should be properly trained before allowing working in the manhole.

### 18.2. Safety Programs:-

- I. Have adequate safety supervision in place to ensure that safety programs set up by the firms/agencies are in compliance with prevalent laws and regulations.
- II. Review safety programs developed by each of the trade firms, prepare and submit a comprehensive safety program.
- III. Monitor day to day implementation of safety procedures.

### 18.3. First Aid Facilities: -

- IV. At every work place there shall be provided and maintained, so as to be easily accessible during working hours, first-aid boxes at the rate of not less than one box for 150 contract labour or part thereof ordinarily employed.
  - i. The first-aid box shall be distinctly marked with a red cross on white back ground.
  - ii. Adequate arrangements shall be made for immediate recoument of the equipment when necessary.
  - iii. Nothing except the prescribed contents shall be kept in the First-aid box.



- iv. The first-aid box shall be kept in charge of a responsible person who shall always be readily available during the working hours of the work place.
- v. A person in charge of the First-aid box shall be a person trained in First-aid treatment, in the work places where the number of contract labour employed is 150 or more.

**19. Discoveries**

- 19.1. Anything of historical or other interest or of significant value unexpectedly discovered on the Site shall be the property of the Employer. The Contractor shall notify the Engineer of such discoveries and carry out the Engineer's instructions for dealing with them.

**20. Possession of the Site**

- 20.1. The Employer shall handover complete or part possession of the site to the Contractor 7 days in advance of construction program. At the start of the work, the Employer shall handover the possession of at-least 75% of the site free of all encumbrances, the remaining 25 % of the possession as per contractor's construction program.

**21. Access to the Site**

- 21.1. The Contractor shall allow access to the Site and to any place where work in connection with the Contract is being carried out, or is intended to be carried out to the Engineer and any person/persons/agency authorized by: a. The Engineer b. The Employer or authorized by the Employer.

**22. Instructions**

- 22.1. The Contractor shall carry out all instructions of the Engineer, which comply with the applicable laws where the Site is located.
- 22.2. The Contractor shall permit the appointed and/or authorized persons to inspect the Site and/or accounts and records of the Contractor and its subcontractors relating to the performance of the Contract, and to have such accounts and records audited by auditors appointed, if so required. The Contractor's attention is invited to Clause of 'Fraud and Corruption', which provides, inter alia, that acts intended to materially impede the exercise of the inspection and audit rights provided for under the Clause & constitute a obstructive practice subject to contract termination.
- 22.3. Engineer to have power to issue further drawings or instructions:
  - The Engineer shall have the power and authority from time to time and at all times to make and issue such further drawings and to give such further instructions and directions as may appear to him necessary or proper for the guidance of the contractor and the good and sufficient execution of the works according to terms of the specifications and Contractor shall receive, execute, obey and be bound by the same, according to the true intent and meaning thereof, as fully and

effectually as though the same had accompanied or had been mentioned or referred to in the specification, and the Engineer may also alter or vary the levels or position of nature of works contemplated by the specifications, or may order any of the works contemplated thereby to be omitted, with or without the substitution of any other works in lieu thereof, or may order any work or any portion of work executed or partially executed, to be removed, changed or altered, added if needful, may order that other works shall be substituted instead thereof and difference of expense occasioned by any such diminution or alteration so ordered and directed shall be added to or deducted from the amount of this Contract, as provided under condition no.10(a) hereinafter.

- No work which radically changes the original nature of the Contract shall be ordered by the Engineer and in the event of any deviation being ordered which in the opinion of the Contractor changes the original nature of Contract he shall nevertheless carry it out and disagreement as to the nature of the work and the rate to be paid therefore shall be resolved in accordance with condition no.13d.
- The time for completion of the Works, shall be in even of any deviations resulting in additional cost over the contract price being ordered, be extended or reduced reasonably by the Engineer. The Engineer's decision in this case shall be final.

### **B. Time Control**

#### **23. Programme**

23.1. Within the time stated in the Contract Data, the Contractor shall submit to the Engineer for approval a Program, including Environment Management Plan showing the general methods, arrangements, order, and timing for all the activities in the Works, along with monthly cash flow forecasts for the construction of works.

After the completion of the construction works, the program for the Routine Maintenance Work, showing the general methods, arrangements, order and timing for all the activities involved in the Routine Maintenance will also be submitted by the Contractor to the Engineer for approval if specified in the tender. The program for Routine Maintenance will be submitted in each year for the period of Maintenance.

23.2. The Contractor shall submit the list of equipment and machinery being brought to site, the list of key personnel being deployed, the list of machinery/ equipment's being placed in field laboratory and the location of field laboratory along with the Programme. The Engineer shall cause these details to be verified at each appropriate stage of the programme.

23.3. An update of the Programme shall be a programme showing the actual progress achieved on each activity and the effect of the progress achieved on the timing of the remaining Works, including any changes to the sequence of the activities.

23.4. The Contractor shall submit to the Engineer for approval an updated Programme at intervals no longer than the period stated in the Contract Data. If the Contractor does not submit an updated Programme within this period, the Engineer may withhold the amount stated in the Contract Data from the next payment certificate and continue to withhold this amount until the next payment after the date on which the overdue Programme has been submitted.

23.5. The Engineer's approval of the Programme shall not alter the Contractor's obligations. The Contractor may revise the Programme and submit it to the Engineer again at any time. A revised Programme shall show the effect of Variations and Compensation Events.

**24. Extension Of Time In Contracts :**

Subject to any requirement in the contract as to completion of any portions or portions of the works before completion of the whole, the contractor shall fully and finally complete the whole of the works comprised in the contract (with such modifications as may be directed under conditions of this contract) by the date entered in the contract or extended date in terms of the following clauses:

**a) Extension attributable to BMC**

(i) **Extension Due To Modification:** If any modifications have been ordered which in the opinion of the Engineer have materially increased the magnitude of the work, then such extension of the contracted date of completion may be granted as shall appear to the Engineer to be reasonable in the circumstances, provided moreover that the Contractor shall be responsible for requesting such extension of the date as may be considered necessary as soon as the cause thereof shall arise and in any case **should not be less than 30 days before the expiry of the date fixed for completion of the works.**

(ii) **Extension For Delay Due To BMC:** In the event of any failure or delay by the BMC to hand over the Contractor possession of the lands necessary for the execution of the works or to give the necessary notice to commence the works or to provide the necessary drawings or instructions or any other delay caused by the BMC due to any other cause whatsoever, then such failure or delay shall in no way affect or vitiate the contract or alter the character thereof or entitle the contractor to damages or compensation therefore, but in any such case, the BMC may grant such extension(s) of the completion date as may be considered reasonable.

**Note: For extension of time period as governed in (i) and (ii) above, any modifications in design/drawings, specifications, quantities shall be needed to be justified with recorded reasons with approval of Ch.Eng. for not anticipating the same while preparing**

**estimates and draft tender.**

- b) **Extension of Time for Delay Due To Contractor:** The time for the execution of the work or part of the works specified in the contract documents shall be deemed to be the essence of the contract and the works must be completed no later than the date(s) / the programme for completion of work as specified in the contract. If the contractor fails to complete the works within the time as specified in the contract for the reasons other than the reasons specified in above as (a.i) and (a.ii), the BMC may, if satisfied that the works can be completed by the contractor within reasonable short time thereafter, allow the contractor for further extension of time as the Engineer may decide. On such extension the BMC will be entitled without prejudice to any other right and remedy available on that behalf, to recover the compensation as governed by Clause 8(e) of GCC.

For the purpose of this Clause, the contract value of the works shall be taken as value of work as per contract agreement including any supplementary work order/contract agreement issued.

**Further, competent authority while granting extension to the currency of contract under Clause (b) of as above may also consider levy of penalty, as deemed fit based on the merit of the case. Also, the reasons for granting extension shall be properly documented.**

**25. Delays Ordered by the Engineer**

- 25.1 The Engineer may instruct the Contractor to delay the start or progress of any activity within the Works. Delay/delays totaling more than 30 days will require prior written approval of the DMC/AMC.

**26. Management Meetings**

- 26.1 The Engineer may require the Contractor to attend a management meeting. The business of a management meeting shall be to review the plans for progress of the Works.
- 26.2 The Engineer shall record the business of management meetings and provide copies of the record to those attending the meeting. The responsibility of the parties for actions to be taken shall be decided by the Engineer either at the management meeting or after the management meeting and stated in writing to all those who attended the meeting.

**C.Quality Control**

- 27.1 **Work to be open to Inspection and Contractor or Responsible agent to be present**

All works under or in course of execution or executed in pursuance of the contract shall at all times be open to the inspection and supervision of the Eng-in-charge and his subordinates and the contractor shall at all times during the usual working hours, at all other times, during the usual working hours and at all other times at which reasonable notice of the intention of the Eng-in-charge and his subordinates to visit the works shall have been given to the contractor, either himself be present to receive orders and instruction or have responsible agent duly accredited in writing present for that purpose. Order given to the contractors' duly authorized agent shall be considered to have the same force and effect as if they had been given to the contractor himself.

**27.2 Notice To Be Given Before Work Is Covered Up**

The contractor shall give not less than ten days' notice in writing to the Eng-In-Charge or his subordinate incharge of the work before covering up or otherwise placing beyond the reach of measurement any work in order that the same may be measured and correct dimension thereof taken before the same is so covered up or placed beyond the reach of measurements and shall not cover up or place beyond the reach of measurement any work without the consent in writing of the Eng-In-Charge or his subordinate in charge of the work, and if any work shall be covered up or placed beyond the reach of measurement, without such notice having been given or consent obtained the same shall be uncovered at the contractors expenses, and in default thereof no payment or allowance shall be made for such work or for the materials with which the same was executed

**27.3 Works to be executed in accordance with specifications / drawings / orders etc. :**

The contractor shall execute the whole and every part of the work the most substantial and workman like manner and both has regards material and every other respect in strict accordance with specifications. The contractor shall also confirm exactly, fully and faithfully to the designs, drawings and instructions in writing relating to the work signed by the Engineer In-charge and lodged in his office and to which the contractor shall be entitled to have access for the purpose of inspection at such office, or on the site or work during office hours. The contractor shall be entitled to receive three sets of contract drawings and working drawings as well as one certified copy of the accepted tender along with the work order free of cost.

**27.4 Ready Mix Concrete/ Asphalt Mix**

- i. The contractor shall have to arrange Ready Mix concrete (RMC)/Asphalt from RMC/ASPHALT producing plants registered with BMC
- ii. The contractor shall, within 7 days of award of the work, submit a list of at least three RMC/Asphalt producers with details of such plants including details and number of transit,

mixers & pumps etc. to be deployed indicating name of owner/company, its location, capacity, technical establishment.

The Engineer-in-charge will reserve right to inspect at any stage and reject the concrete if he is not satisfied about quality of product at the user's end.

iii. The Engineer-in-charge reserves the right to exercise control over the:-

- a. Calibration check of the RMC/Asphalt plant.
- b. Weight and quantity check on the ingredients, water and admixtures added for batch mixing for RMC plants
- c. Time of mixing of concrete/grade of asphalt.
- d. Testing of fresh concrete/asphalt mix, recording of results and declaring the mix fit or unfit for use. This will include continuous control on the work ability during production and taking corrective action, if required.
- e. For exercising such control, the Engineer-in-charge shall periodically depute his authorized representative at the RMC/Asphalt plant. It shall be responsibility of the contractor to ensure that all necessary equipment, manpower & facilities are made available to Engineer-in-charge and or his authorized representative at RMC/Asphalt plant.
- f. All required relevant records of RMC/Asphalt mix shall be made available to the Engineer-in-charge or his authorized representative. Engineer-in-charge shall, as required, specify guidelines & additional procedures for quality control & other parameters in respect of material production & transportation of concrete mix which shall be binding on the contractor & the RMC/Asphalt plant. Only concrete as approved in design mix by Engineer-in-charge shall be produced in RMC plant and transported to the site.
- g. The contractor shall have to produce a copy of chalan receipts/SCADA reports/VTS reports as issued by the RMC/Asphalt plant as a documentary proof in lieu of supply of RMC/Asphalt mix before releasing payment.

## **28 Identifying Defects**

28.1 The Engineer shall check the Contractor's work and notify the Contractor of any Defects that are found. Such checking shall not affect the Contractor's responsibilities. The Engineer may instruct the Contractor to search for a Defect and to uncover and test any work that the Engineer considers may have a Defect.

28.2 The Contractor shall permit the Employer's technical person(s) to check the Contractor's work and notify the Engineer and Contractor if any defects that are found.

## 29 Tests

29.1 For carrying out mandatory tests as prescribed in the specifications, the Contractor shall establish field laboratory at the location decided by Engineer. The field laboratory will have minimum of equipment's as specified in the Contract Data. The contractor shall be solely responsible for:

- a. Carrying out the mandatory tests prescribed in the Specifications, and
- b. For the correctness of the test results, whether preformed in his laboratory or elsewhere.

29.2 If the Engineer instructs the Contractor to carry out a test not specified in the Specification/ Quality Assurance Handbook to check whether any work has a Defect and the test shows that it does, the Contractor shall pay for the test and any samples. If there is no defect, the test shall be a compensation event.

When required by the Engineer-in-charge the contractor(s) shall supply for the purpose of testing samples of all materials proposed to be used in the works. Samples submitted either to govern bulk supplies or required for testing before use shall be in suitable packages to contain them and shall be provided free of charge by the contractor. The cost of testing shall be borne by the contractor even if the result of the sample confirm or do not confirm to the relevant BIS code specifications.

- i. All expenditure required to be incurred for taking the samples conveyance, packing shall be borne by the contractor himself.
- ii. The failed material shall be removed from the site by the contractor at his own cost within a week time of written order of the Engineer-in-charge.

### 29.3 Setting of Site Laboratories:

Contractors shall set up a laboratory at site before commencement of work at their cost for performing various tests and at least the following machines and equipment's shall be provided therein –

1. Set of Sieves as per I.R.C. /I.S.
2. Compressive Testing Machine(For new works)
3. Oven, Electrically Operated
4. Weighing Balance (20 kg capacity)
5. 3 m straight edge
6. Sieve shaker
7. First Aid Box
8. Measuring Jar (for silt content)

9. Other Machines/apparatus as may be directed by the Engineer
10. Vernier Caliber
11. Level / Theodolite

All the test records shall be maintained in the site office and made available as and when required. The laboratory must be established within 15 days from the date of receipt of the orders from Engineer In charge. On failure to do so, a penalty of Rs 1000/- per day shall be imposed.

The contractor shall install testing equipment at site. The contractor shall ensure and certify the calibration of the equipment so installed and shall maintain the same in working order throughout the period of construction. The contractor shall also provide necessary technically qualified experienced trained staff for carrying out such tests for using such equipment. The tests shall be carried out under the supervision of the Engineer-in-charge. The calibration shall be checked every twelve months as directed by Engineer-in-charge.

### **30 Correction of Defects noticed during the Defects Liability Period.**

- 30.1 (a) The Engineer shall give notice to the Contractor of any Defects before the end of the Defects Liability Period, which begins at Completion and ends after five years. The Defects Liability Period shall be extended for as long as Defects remain to be corrected.
- (b) Every time notice of Defect/Defects is given, the Contractor shall correct the notified Defect/Defects within the duration of time specified by the Engineer's notice.
- (c) The Engineer may issue notice to the Contractor to carry out removal of defects or deficiencies, if any, noticed in his inspection, or brought to his notice. The Contractor shall remove the defects and deficiencies within the period specified in the notice and submit to the Engineer a compliance report.

### **31. Uncorrected Defects and Deficiencies**

- 31.1 If the Contractor has not corrected a Defect pertaining to the Defect Liability Period under clause and deficiencies in maintenance, to the satisfaction of the Engineer, within the time specified in the Engineer's notice, the Engineer will assess the cost of having the Defect or deficiency corrected, and the Contractor shall pay this amount, on correction of the Defect or deficiency by another agency.

## **D. Cost Control**

### **32. Variations**

The Engineer shall, having regard to the scope of the Works and the sanctioned estimated cost, have power to order, in writing, Variations within the scope of the Works he considers necessary or advisable during the progress of the Works. Such Variations shall form part of the Contract and the Contractor shall



carry them out and include them in updated Programmes produced by the Contractor. Oral orders of the Engineer for Variations, unless followed by written confirmation, shall not be taken into account.

### **33. Payments for Variations**

- 33.1 If rates for Variation items are specified in the Bill of Quantities, the Contractor shall carry out such work at the same rate.
- 33.2 The rate for Extra/Excess shall be governed by clause 10.A of Standard General Condition of Contract

### **34. Cash Flow Forecasts**

When the Programme is updated, the Contractor shall provide the Engineer with an updated cash flow forecast.

### **35. Payment Certificates**

The payment to the Contractor will be as follows for construction work:

- (a) A bill shall be submitted by the Contractor monthly or before the date fixed by the Engineer In-charge for all works executed in the previous month, and the Engineer In-charge shall take or cause to be taken requisite measurement for the purpose of having the same verified and the claim, so far as it is admissible, shall be adjusted, if possible, within 10 days from the presentation of the bill. If the contractor does not submit the bill within the time fixed as aforesaid, the Engineer In-charge may depute a subordinate to measure up the said work in the presence of the contractor or his duly authorized agent whose counter signature to the measurement list shall be sufficient warrant, and Engineer In-Charge may prepare a bill from such list which shall be binding on the contractor in all respects.
- (b) The Engineer shall check the Contractor's fortnightly/monthly statement within 14 days and certify the amount to be paid to the Contractor.
- (c) The value of work executed shall be determined, based on measurements by the Engineer.
- (d) The value of work executed shall comprise the value of the quantities of the items in the Bill of Quantities completed.
- (e) The value of work executed shall also include the valuation of Variations and Compensation Events.
- (f) The Engineer may exclude any item certified in a previous certificate or reduce the proportion of any item previously certified in any certificate in the light of later information.
- (g) The contractor shall submit all bills on the printed forms at the office of Engineer In-charge. The charges to be made in the bills shall always be entered at the rates specified in tender.

**36. Payments**

- 36.1 Payments shall be adjusted for deductions for advance payments, retention, security deposit, other recoveries in terms of the Contract and taxes at source, as applicable under the law. The Employer shall pay the Contractor the amounts certified by the Engineer within 15 days of the date of each certificate.
- 36.2 All sums payable by a contractor by way of compensation under any of these conditions, shall be considered as a reasonable compensation to be applied to the use of BMC without reference to the actual loss or damage sustained and whether any damage has or has not been sustained.
- 36.3 No payment shall be made for any work estimated to cost less than Rupees One Thousand till after the whole of work shall have been completed and the certificate of completion given. But in the case of works estimated to cost more than Rs. One Thousand, the contractor shall on submitting a monthly bill therefore be entitled to receive payment proportionate to the part of the work than approved and passed by the Engineer In-charge, whose certificate of such approval and passing of the sum so payable shall be final and conclusive against the contractor. All such intermediate payments shall be regarded as payments by way of advance against the final payments only and not as payments for work actual done and completed and shall not preclude the Engineer In-charge from requiring any bad, unsound, imperfect or unskillful work to be removed or taken away and reconstructed or re-erected nor shall any such payment be considered as an admission of the due performance of the contract or any part thereof in any respect or the offering of any claim not shall it conclude, determine or effect in any other way, the powers of the Engineer In-charge as to the final settlement and adjustment of the accounts or otherwise, or in any other way vary or effect the contract. The final bill shall be submitted by the Contractor within one month of the date fixed for the completion of the work otherwise the Engineer In-charge's certificate of the measurements and of the total amount payable for the work shall be final and binding on all parties.
37. The Contractor shall not be entitled to compensation to the extent that the Employer's interests are adversely affected by the Contractor for not having given early warning or not having cooperated with the Engineer.

**38. Tax**

All taxes, duties, cess and charges such as Octroi, Service Tax, Terminal or Sales Tax, VAT etc. and other duties on material obtained for the work from any source including the tax applicable as per Maharashtra Sales Tax Act, on the transfer of property in goods involved in the execution of work contract (re-enacted) Act 1989 or as amended shall be borne by tenderer. The tenderer will not be reimbursed the taxes, duties, cess and charges whether now in force or that may be enforced in future.

Rates accepted by MCGM shall hold good till completion of work and no additional individual claim shall be admissible on account of fluctuations in market rates; increase in taxes/any other levies/tolls etc. except that payment/recovery for overall market situation shall be made as per Price Variation.

**39. Currencies**

All payments will be made in Indian Rupees.

**40. Liquidated Damages**

Both, the Contractor and the Employer have agreed that it is not feasible to precisely estimate the amount of losses due to delay in completion of works and the losses to the public and the economy, therefore, both the parties have agreed that the Contractor shall pay liquidated damages to the Employer and not by way of penalty, at the rate per week or part thereof stated in the Contract Data for the period that the Completion Date is later than the Intended Completion Date. Liquidated damages at the same rates shall be withheld if the Contractor fails to achieve the milestones prescribed in the Contract Data. However, in case the Contractor achieves the next milestone, the amount of the liquidated damages already withheld shall be restored to the Contractor by adjustment in the next payment certificate. The Employer and the contractor have agreed that this is a reasonable agreed amount of liquidated damage. The Employer may deduct liquidated damages from payments due to the Contractor. Payment of liquidated damages shall not affect the Contractor's other liabilities.

**41. Cost of Repairs**

Loss or damage to the Works or Materials to be incorporated in the Works between the Start Date and the end of the Defects Correction periods shall be remedied by the Contractor at his cost if the loss or damage arises from the Contractor's acts or omissions.

**E. Finishing the Contract****42. Completion of Construction and Maintenance**

42.1 The Contractor shall request the Engineer to issue a certificate of completion of the construction of the works, and the Engineer will do so upon deciding that the works is completed. This shall be governed as per clause no.8(g) of Standard General Conditions of Contract.

**43. Taking Over**

43.1 The Employer shall take over the works within seven days of the Engineer issuing a certificate of completion of works. The Contractor shall continue to remain responsible for its routine maintenance during the maintenance period if specified in the contract.

**44. Final Account**

Final joint measurement along with the representatives of the contractor should be taken recorded and signed by the Contractors. Contractors should submit the final bill within 1 month of physical completion of the work.

If the contractor fails to submit the final bill within 1 month, the BMC staff will prepare the final bill based on the joint measurement within next 3 months.

Engineer's decision shall be final in respect of claims for defect and pending claims against contractors.

No further claims should be made by the Contractor after submission of the final bill and these shall be deemed to have been waived and extinguished. Payment of those items of the bills in respect of which there is no dispute and of items in dispute, for quantities and rates as approved by the Commissioner shall be made within a reasonable period as may be necessary for the purpose of verification etc.

After payment of the final bill as aforesaid has been made, the contractor may, if he so desires, reconsider his position in respect of a disputed portion of the final bills and if he fails to do so within 84 days, his disputed claim shall be dealt with as provided in the contract.

A percentage of the retention money, over and above the actual retention money as indicated below shall be held back from payments till the finalization of final bill to be submitted as per above and will be paid within 30 days of acceptance of the final bill.

Sr.no.	Amount of Contract Cost	Minimum Payable Amount in final bill
1	Upto Rs.5 Crs.	Rs.10 Lacs or final bill whichever is more
2	Upto Rs.25 Crs.	Rs.1 Crore or final bill amount whichever is more
3	UptoRs. 50 Crs.	Rs.2 Crores or final bill amount whichever is more
4	Upto Rs.100 Crs.	Rs.4 Crore or final bill amount whichever is more
5	More than Rs.100 Crs..	Rs.7 Crore or final bill amount whichever is more

The contractor has to submit the bill for the work carried out within 15 days from the date of completion of the work to the respective executing department. If the contractor fails to submit their bills to concerned executing department, penalty or action as shown below will be taken for each delayed bill:-

After 15 days from the date of completion/running bill upto certain date, upto next 15 days i.e. upto 30 days	Equal to 5% of bill amount
Next 15 days upto 45 days from the date of completion/running bill upto specified date	Equal to 10% of bill amount
If not submitted within 45 days from the date of completion/ R.A. bill	Bill will not be admitted for payment.

**45. Operating and Maintenance Manuals**

45.1 If "as built" Drawings and/or operating and maintenance manuals are required, the Contractor shall supply them by the dates stated in the Contract Data.

45.2 If the Contractor does not supply the Drawings and/or manuals by the dates stated in the Contract Data, or they do not receive the Engineer's approval, the Engineer shall withhold the amount stated in the Contract Data from payments due to the Contractor.

#### **46. Termination**

46.1 The Employer or the Contractor may terminate the Contract if the other party causes a fundamental breach of the Contract.

46.2 Fundamental breaches of Contract shall include, but shall not be limited to, the following:

- a) The Contractor stops work for 30 days when no stoppage of work is shown on the current Programme and the stoppage has not been authorized by the Engineer;
- b) The Contractor is declared as bankrupt or goes into liquidation other than for approved reconstruction or amalgamation;
- c) the Engineer gives Notice that failure to correct a particular Defect is a fundamental breach of Contract and the Contractor fails to correct it within a reasonable period of time determined by the Engineer;
- d) The Contractor does not maintain a Security, which is required;
- e) The Contractor has delayed the completion of the Works by the number of days for which the maximum amount of liquidated damages can be paid, as defined in relevant clause.
- f) The Contractor fails to provide insurance cover as required under relevant clause .
- g) If the Contractor, in the judgment of the Employer, has engaged in the corrupt or fraudulent practices as defined in GCC in competing for or in executing the Contract.
- h) If the Contractor fails to set up a field laboratory with the prescribed equipment, within the period specified in the Contract Data; and
- i) Any other fundamental breaches as specified in the Contract Data.
- j) If the Contractor fails to deploy machinery and equipment or personnel as specified in the Contract Data at the appropriate time.

46.3 When either party to the contract gives notice of a breach of contract to the Engineer for a cause other than those listed above, the Engineer shall decide whether the breach is fundamental or not.

46.4 Notwithstanding the above, the Employer may terminate the Contract for convenience.

46.5 If the Contract is terminated, the Contractor shall stop work immediately, make the Site safe and secure, and leave the Site as soon as reasonably possible.

**47. Payment upon Termination**

47.1 If the Contract is terminated because of a fundamental breach of Contract by the Contractor, the Engineer shall issue a certificate for value of the work done and materials ordered less liquidated damages, if any, less advance payments received up to the date of the issue of the certificate and less the percentage to apply to the value of the work not completed, as indicated in the Contract Data. If the total amount due to the Employer exceeds any payment due to the Contractor, the difference shall be recovered from the security deposit, and performance security. If any amount is still left un-recovered it will be a debt due from the Contractor to the Employer

47.2 If the Contract is terminated at the Employer's convenience, the Engineer shall issue a certificate for the value of the work done, the reasonable cost of removal of Equipment, repatriation of the Contractor's personnel employed solely on the Works, and the Contractor's costs of protecting and securing the Works and less advance payments received up to the date of the certificate, less other recoveries due in terms of the Contract, and less taxes due to be deducted at source as per applicable law.

**48. Property**

48.1 All Materials on the Site, Plant, Equipment, Temporary Works, and Works shall be deemed to be the property of the Employer for use for completing balance construction work if the Contract is terminated because of the Contractor's default, till the Works is completed after which it will be transferred to the Contractor and credit, if any, given for its use.

**49. Release from Performance**

If the Contract is frustrated by the outbreak of war or by any other event entirely outside the control of the Employer or the Contractor, the Engineer shall certify that the Contract has been frustrated. The Contractor shall make the Site safe and stop work as quickly as possible after receiving this certificate and shall be paid for all work carried out before receiving it and for any work carried out afterwards to which a commitment was made.

**A) Other Conditions of Contract****50. Labour**

50.1 The Contractor shall, unless otherwise provided in the Contract, make his own arrangements for the engagement of all staff and labour, local or other, and for their payment, housing, feeding and transport.

50.2 The Contractor shall, if required by the Engineer, deliver to the Engineer a return in detail, in such form and at such intervals as the Engineer may prescribe, showing the staff and the number of the several classes of labour from time to time employed by the Contractor on the Site and such other information as the Engineer may require.

**51. Compliance with Labour Regulations**

(a) During continuance of the Contract, the Contractor and his sub-Contractors shall abide at all times by all existing labour enactments and rules made there under, regulations, notifications and bye laws of the State or Central Government or local authority and any other labour law (including rules), regulations, bye laws that may be passed or notification that may be issued under any labour law in future either by the State or the Central Government or the local authority.

(b) Furthermore, the Contractor shall keep the Employer indemnified in case any action is taken against the Employer by the competent authority on account of contravention of any of the provisions of any Act or rules made there under, regulations or notifications including amendments. If the Employer is caused to pay or reimburse, such amounts as may be necessary to cause or observe, or for non-observance of the provisions stipulated in the notifications/bye laws/Acts/Rules/regulations including amendments, if any, on the part of the Contractor, the Engineer/Employer shall have the right to deduct any money due to the Contractor including his amount of performance guarantee. The Employer/Engineer shall also have right to recover from the Contractor any sum required or estimated to be required for making good the loss or damage suffered by the Employer.

(c) The Contractor shall require his employees to obey all applicable laws, including those concerning safety at work.

(d) The employees of the Contractor and the Sub-Contractor in no case shall be treated as the employees of the Employer at any point of time.

**52. Drawings and Photographs of the Works**

52.1 The Contractor shall do photography/video photography of the site firstly before the start of the work, secondly mid-way in the execution of different stages of work as required by Engineer In-charge and lastly after the completion of the work. No separate payment will be made to the Contractor for this.

52.2 The Contractor shall not disclose details of Drawings furnished to him and works on which he is engaged without the prior approval of the Engineer in writing. No photograph of the works or any part thereof or plant employed thereon, except those permitted under above clause, shall be taken or permitted by the Contractor to be taken by any of his employees or any employees of his sub-Contractors without the prior approval of the Engineer in writing. No photographs/ Video photography shall be published or otherwise circulated without the approval of the Engineer in writing.

**53. The Apprentices Act, 1961**

The Contractor shall duly comply with the provisions of the Apprentices Act 1961 (III of 1961), the rules made there under and the orders that may be issued from time to time under the said Act and the said Rules and on his failure or neglect to do so, he shall be subject to all liabilities and penalties provided by the said Act and said Rules.

**54 Contract Document**

The documents forming the contract are to be taken as mutually explanatory of one another. Unless otherwise provided in the contract, the priority of the documents forming the contract shall be, as follows:

- 1) Contract Agreement (if completed)
- 2) The letter of Acceptance
- 3) The Bid:
- 4) Addendum to Bid; if any
- 5) Tender Document
- 6) The Bill of Quantities:
- 7) The Specification:
- 8) Detailed Engineering Drawings
- 9) Standard General Conditions of Contracts (GCC)



- 10) All correspondence documents between bidder/contractor and BMC.

### **55 Conflict of Interest**

The Applicant shall not have a conflict of interest (the “Conflict of Interest”) that affects the Bidding Process. Any Applicant found to have a Conflict of Interest shall be disqualified. An Applicant shall be deemed to have a Conflict of Interest affecting the Bidding Process, if

1. A constituent of such Applicant is also a constituent of another Applicant; or
2. Such Applicant has the same legal representative for purposes of this Application as any other Applicant; or
3. Such Applicant, or any Associate thereof has a relationship with another Applicant, or any Associate thereof, directly or through common third party/ parties, that puts either or both of them in a position to have access to each other’s information about, or to influence the Application of either or each other; or
4. The Applicant shall be liable for disqualification if any legal, financial or technical adviser of the Authority in relation to the Project is engaged by the Applicant, its Member or any Associate thereof, as the case may be, in any manner for matters related to or incidental to the Project. For the avoidance of doubt, this disqualification shall not apply where such adviser was engaged by the Applicant, its Member or Associate in the past but its assignment expired or was terminated 6 (six) months prior to the date of issue of this TENDER. Nor will this disqualification apply where such adviser is engaged after a period of 3 (three) years from the date of commercial operation of the Project.

### **56. Applications and costs thereof**

No Applicant shall submit more than one Application for the Project. An applicant applying individually shall not be entitled to submit another application either individually. The Applicant shall be responsible for all of the costs associated with the preparation of their Applications and their participation in the Bid Process. The Authority will not be responsible or in any way liable for such costs, regardless of the conduct or outcome of the Bidding Process.

### **57 Acknowledgment by Applicant**

It shall be deemed that by submitting the Application, the Applicant has:

- a. made a complete and careful examination of the tender;
- b. received all relevant information requested from the Authority;
- c. accepted the risk of inadequacy, error or mistake in the information provided in the tender or

- furnished by or on behalf of the Authority relating to any of the matters referred; and
- d. Agreed to be bound by the undertakings provided by it under and in terms hereof.

“The Authority” shall not be liable for any omission, mistake or error in respect of any of the above or on account of any matter or thing arising out of or concerning or relating to the TENDER or the Bidding Process, including any error or mistake therein or in any information or data given by the Authority.

### **58 Right to accept or reject any or all Applications/ Bids**

Notwithstanding anything contained in this TENDER, “The Authority” reserves the right to accept or reject any Application and to annul the Bidding Process and reject all Applications/ Bids, at any time without any liability or any obligation for such acceptance, rejection or annulment, and without assigning any reasons therefore. In the event that the Authority rejects or annuls all the Bids, it may, in its discretion, invite all eligible Bidders to submit fresh Bids hereunder.

“The Authority” reserves the right to reject any Application and/ or Bid if:

- (a) at any time, a material misrepresentation is made or uncovered, or
- (b) The Applicant does not provide, within the time specified by the Authority, the supplemental information sought by the Authority for evaluation of the Application.

In case it is found during the evaluation or at any time before signing of the Agreement or after its execution and during the period of subsistence thereof including the concession thereby granted by “The Authority”, that one or more of the pre-qualification conditions have not been met by the Applicant, or the Applicant has made material misrepresentation or has given any materially incorrect or false information, the Applicant shall be disqualified forthwith if not yet appointed as the Successful Bidder either by issue of the LOA (Letter of Approval) or entering into of the Agreement, and if the Applicant has already been issued the LOA or has entered into the Concession Agreement, as the case may be, the same shall, notwithstanding anything to the contrary contained therein or in this TENDER, be liable to be terminated, by a communication in writing by “The Authority” to the Applicant, without the Authority being liable in any manner whatsoever to the Applicant and without prejudice to any other right or remedy which the Authority may have under this TENDER, the Bidding Documents, the Concession Agreement or under applicable law.

“The Authority” reserves the right to verify all statements, information and documents submitted by the Applicant in response to the TENDER. Any such verification or lack of such verification by the Authority shall not relieve the Applicant of its obligations or liabilities hereunder nor will it affect any rights of the Authority there under.

**59 The bid shall be rejected if the bidder-**

- a. Stipulates the validity period less than 180 days.
- b. Stipulates own condition/conditions.
- c. Does not fill and (digital) sign undertaking forms, which are incorporated, in the document.

**60 Clarifications**

Applicants requiring any clarification on the tender may notify “the Authority” in writing or by fax or e-mail. They should send in their queries before the date specified in the header data. “The Authority” shall Endeavor to respond to the queries within the period specified therein. The responses will be sent by fax and/or e-mail. The Authority will forward all the queries and its responses thereto, to all purchasers of the TENDER without identifying the source of queries.

“The Authority” shall Endeavor to respond to the questions raised or clarifications sought by the Applicants. However, the Authority reserves the right not to respond to any question or provide any clarification, in its sole discretion, and nothing in this Clause shall be taken or read as compelling or requiring the Authority to respond to any question or to provide any clarification, but not later than the date provided in header data.

“The Authority” may also on its own motion, if deemed necessary, issue interpretations and clarifications to all Applicants. All clarifications and interpretations issued by the Authority shall be deemed to be part of the tender. Verbal clarifications and information given by Authority or its employees or representatives shall not in any way or manner be binding on the Authority.

**61 Amendment of tender**

At any time prior to the deadline for submission of Application, the Authority may, for any reason, whether at its own initiative or in response to clarifications requested by an Applicant, modify the tender by the issuance of Addendum.

Any Addendum thus issued will be sent in writing/ Fax/ Email to all those who have purchased the tender.

In order to afford the Applicants a reasonable time for taking an Addendum into account, or for any other reason, the Authority may, in its sole discretion, extend the Application Due Date.

**Preparation and Submission of Application****62 Language**

The Application and all related correspondence and documents in relation to the Bidding Process shall be in English language. Supporting documents and printed literature furnished by the

Applicant with the Application may be in any other language provided that they are accompanied by translations of all the pertinent passages in the English language, duly authenticated and certified by the Applicant. Supporting materials, which are not translated into English, may not be considered. For the purpose of interpretation and evaluation of the Application, the English language translation shall prevail.

**63 Format and signing of Application**

The Applicant shall provide all the information sought under this TENDER. The Authority will evaluate only those Applications that are received in the required formats and complete in all respects. Incomplete and /or conditional Applications shall be liable to rejection.

The Applicant will upload bid in One Folder in electronic form which shall contain the scanned certified copies of the documents given below and the documents uploaded has to be digitally signed by the bidder. These copies shall be certified by Practicing Notary approved by the Govt. of Maharashtra or Govt. of India with his stamp, clearly stating his name & registration number, except where original documents are demanded

**64 Marking of Applications**

The Applicant shall submit the Application in the format specified at Appendix-I, together with the documents, upload in folder as “VENDOR” together with their respective enclosures Applications submitted by fax, telex, telegram shall not be entertained and shall be rejected outright.

**65 Late Applications**

Applications received by the Authority after the specified time on the Application Due Date shall not be eligible for consideration and shall be summarily rejected.

**66 Confidentiality**

Information relating to the examination, clarification, evaluation, and recommendation for the short-listed qualified Applicants shall not be disclosed to any person who is not officially concerned with the process or is not a retained professional advisor advising the Authority in relation to or matters arising out of, or concerning the Bidding Process. The Authority will treat all information, submitted as part of Application, in confidence and will require all those who have access to such material to treat the same in confidence. The Authority may not divulge any such information unless it is directed to do so by any statutory entity that has the power under law to require its disclosure or is to enforce or assert any right or privilege of the statutory entity and/ or the Authority or as may be required by law or in connection with any legal process.

**67 Clarification Of Financial Bids**

To assist in the examination, evaluation and comparison of Bids, the Engineer may, at his

discretion, ask any bidder for clarification of his Bid, including breakdown of unit rates. The request for clarification and the response shall be in writing or by post/facsimile/e-mail. No Bidder shall contact the Engineer on any matter relating to his bid from the time of the bid opening to the time the contract is awarded. Any effort by the Bidder to influence the Engineer in the Engineer's bid evaluation, bid comparison or contract award decisions may result in the rejection of the Bidder's bid.

#### **68 Inspection of site and sufficiency of tender:**

1. The Contractor shall inspect and examine the site and its surrounding and shall satisfy himself before submitting his tender as to the nature of the ground and subsoil (so far as is practicable), the form and nature of the site, the quantities and nature of the work and materials necessary for the completion of the works and means of access to the site, the accommodation he may require and in general shall himself obtain all necessary information as to risk, contingencies and other circumstances which may influence or affect his tender. He shall also take into consideration the hydrological and climatic conditions.
2. The Employer may make available to the Contractor data on hydrological and sub-surface conditions as obtained by or on his behalf from investigations relevant to the works but the Contractor shall be responsible for his own interpretation thereof. The contractor shall engage his investigating agency with prior approval of the Engineer from the approved list of such agencies by BMC or Govt at his cost initially before commencing actual work and which shall be reimbursed immediately subject to satisfaction of the Engineer for faithful compliance and submission of required data regarding such investigation within specified time.
3. The Contractor shall be deemed to have satisfied himself before tendering as to the correctness and sufficiency of his tender for the works and of the rates and prices quoted in the schedule of works / items / quantities, or in Bill of Quantities, which rates and prices shall, except as otherwise provided cover all his obligations under the Contract and all matters and things necessary for proper completion and maintenance of the works. No extra charges consequent on any misunderstanding.
4. **Not Foreseeable Physical Obstructions or Conditions:** If, however, during the execution of the Works the Contractor encounters physical obstructions or physical conditions, other than climatic conditions on the Site, which obstructions or conditions were, in his opinion, not foreseeable by an experienced contractor, the Contractor shall forthwith give notice thereof to the Engineer. On receipt of such notice, the Engineer shall, if in his opinion such obstructions or

conditions could not have been reasonably foreseen by an experienced contractor, after due consultation with the Contractor, determine:

- any extension of time to which the Contractor is entitled and
- The amount of any costs which may have been incurred by the Contractor by reason of such obstructions or conditions having been encountered, which shall be added to the Contract Price.
- and shall notify the Contractor accordingly. Such determination shall take account of any instruction which the Engineer may issue to the Contractor in connection therewith, and any proper and reasonable measures acceptable to the Engineer which the Contractor may take in the absence of specific instructions from the Engineer. However such costings shall be got approved by the competent authority as governed vide rules prevailing with authority.

5. **Office for the Engineer (Works costing upto Rs.50 Lakhs)**

The Contractor shall at his own cost and to satisfaction of the Engineer provide a small temporary office, at the work-site which will include tables, chairs and lockers for keeping the records. He shall also make necessary arrangements for drinking water, telephone with a pre-requisite of e-governance and electronic communication. These offices are not to be allowed on public roads without the written instruction of the Engineer. These offices should be preferably located within 50 to 500 m of the worksite. ~~In case the office is more than 500m away from the worksite, the contractor is to provide conveyance for Municipal Staff.~~

6. **Office for the Engineer (Works costing above Rs.50 lakhs)**

The Contractor shall at his own cost and to satisfaction of the Engineer provide a temporary office at the work-site which will include tables, chairs and lockers for keeping the records. He shall also make necessary arrangements for drinking water, latrines, with doors, windows, locks, bolts and fastenings sufficient for security for the Engineer, and his subordinates, as close to the works from time to time in progress as can be conveniently arranged, and shall at his own cost furnish the office with such chairs, tables, lockers, locks and fastenings as may be required by the Engineer, and no expense of any kind in connection with the erection or upkeep of the offices or fittings shall be borne by the Corporation, but all such work shall be carried out by the Contractor and the expenses thereof defrayed by him. The Contractor shall also make water connections and fit up stand pipe with a bib tap at each office. The latrines and the water connections shall be subject to all the conditions herein elsewhere laid down for temporary water connection and latrines generally with all requisite equipment's for e-governance and electronic and digital communication. These offices are not to be allowed on public roads without the written instruction of the Engineer. These offices should be preferably located within 50 to 500 m of the worksite. ~~In case the office is more than 500m away from the worksite, the contractor is to~~

~~provide conveyance. Also, for staff working beyond working hours the contractor has to provide conveyance.~~

7. **Permission for provision and removal of office on completion of work:** The tenderer shall obtain permission for provision of site office, cement go-down, store, etc. on payment of necessary cost implication. The cement go-down, Watchman cabins, etc. shall be provided as directed and shall be removed by the Tenderers on completion of the work at their cost. It is binding on the Tenderer to fulfill requirements of Environmental Authorities. The location of such office shall be finalized and got approved from the Engineer before erection/commencement work.

8. **Contractor's office near works:** The Contractor shall have an office near the works at which notice from the Commissioner or the Engineer may be served and shall, between the hours of sunrise and sunset on all working days, have a clerk or some other authorized person always present at such office upon whom such notices may be served and service of any notices left with such clerk or other authorized person or at such office shall be deemed good service upon the Contractor and such offices shall have pre-requisite facilities for e-governance.

#### **69 Official Secrecy:**

The Contractor shall of all the persons employed in any works in connection with the contract that the India Official Secrets Act 1923 (XIX of 1923) applies to them and will continue to apply even after execution of the said works and they will not disclose any information regarding this contract to any third party. The contractor shall also bring into notice that, any information found to be leaked out or disclosed the concern person as well as the Contractor will be liable for penal action; further the Corporation will be at liberty to terminate the contract without notice.

#### **70 Subsequent Legislation:**

If on the day of submission of bids for the contract, there occur changes to any National or State stature, Ordinance, decree or other law or any regulation or By-laws or any local or other duly constituted authority or the introduction of any such National or State Statute, Ordinance, decree or by which causes additional or reduced cost to the Contractor, such additional or reduced cost shall, after due consultation with the Contractor, be determined by the concerned Engineering Department of BMC and shall be added to or deducted from the Contract Price with prior approval of competent authority and the concerned Engineering Department shall notify the

Contractor accordingly with a copy to the Employer. BMC reserve the right to take decision in respect of addition/reduction of cost in contract.

**71 Patent, Right and Royalties:**

The contractor shall save harmless and indemnify the Corporation from and against all claims and proceedings for or on account of infringement of any Patent rights, design trademark or name of other protected rights in respect of any constructional plant, machine work, or material used for or in connection with the Works or any of them and from and against all claims, proceedings, damages, costs, charges and expenses whatsoever in respect thereof or in relation thereto. Except where otherwise specified, the contractor shall pay all tonnage and other royalties, rent and other payments or compensation, if any, for getting stone, sand, gravel, clay or other materials required for the works or any of them.

**72 Payments, Tax and Claims:**

- **The limit for unforeseen claims**

Under no circumstances whatever the contractor shall be entitled to any compensation from BMC on any account unless the contractor shall have submitted a claim in writing to the Eng-in-change within 1 month of the case of such claim occurring.

- **No interest for delayed payments due to disputes, etc:**

It is agreed that the Brihanmumbai Municipal Corporation or its Engineer or Officer shall not be liable to pay any interest or damage with respect of any moneys or balance which may be in its or its Engineer's or officer's hands owing to any dispute or difference or claim or misunderstanding between the Brihanmumbai Municipal Corporation (BMC) or its Engineer or Officer on the one hand and the contractor on the other, or with respect to any delay on the part of the Brihanmumbai Municipal Corporation (BMC) or its Engineer or Officers in making periodical or final payments or in any other respect whatever.

**73 Settlement of Disputes:**

- **Termination of contract for death**

If the Contractor is an individual or a proprietary concern and the individual or the proprietor dies and if the Contractor is a partnership concern and one of the legal representative of the individual Contractor or the proprietor of the proprietary concern and in case of partnership, the surviving partners, are capable of carrying out and completing the contract, the Commissioner shall be entitled to cancel the contract as to its uncompleted part without the Corporation being in any way liable to payment of any compensation to the estate of the deceased Contractor and or to the surviving partners of the Contractor's firm on account of the cancellation of the contract. The decision of the Commissioner that the legal representative of the deceased Contractor or surviving



partners of the Contractor's firm cannot carry out and complete the contract shall be final and binding on the parties. In the event of such cancellation the Commissioner shall not hold estate of the deceased Contractor and or surviving partners of the Contractor's firm liable in damages for not completing the contract.

• **Settlement of Disputes:**

If any dispute or differences of any kind whatsoever other than those in respect of which, the decision of any person is, by the Contract, expressed to be final and binding) shall arise between the Employer and the Contractor or the Engineer and the Contractor in connection with or arising out of the Contract or carrying out of the Works (Whether during the progress of the Works or after their completion and whether before or after the termination, abandonment or breach of the Contract) it, the aggrieved party may refer such dispute within a period of 7 days to the concerned Addl. Municipal Commissioner who shall constitute a committee comprising of three officers i.e. concerned Deputy Municipal Commissioner or Director (ES&P), Chief Engineer other than the Engineer of the Contract and concerned Chief Accountant. The Committee shall give decision in writing within 60 days. Appeal on the Order of the Committee may be referred to the Municipal Commissioner within 7 days. Thereafter the Municipal Commissioner shall constitute a Committee comprising of three Addl. Municipal Commissioners including Addl. Municipal Commissioner in charge of Finance Department. The Municipal Commissioner within a period of 90 days after being requested to do so shall give written notice of committee's decision to the Contractor. Save as herein provided such decision in respect of every matter so referred shall be final and binding upon both parties until the completion of the works, and shall forthwith be given effect to by the Contractor who shall proceed with the works with due diligence, whether he requires arbitration as hereinafter provided or not. If the Commissioner has given written notice of the decision to the Contractor and no Claim to arbitration has been communicated within a period of 90 days from receipt of such notice the said decision shall remain final and binding upon the Contractor.

**74 Arbitration and Jurisdiction:**

**As per Hon. M.C.'s approval dtd. 17.08.2019, the existing clause is now replaced as follows (copy of the circular is attached at pg. 254 to 257)**

If the Commissioner shall fails to give notice of the decision as aforesaid within a period of 90 days after being requested as aforesaid, or if the Contractor is dissatisfied with any such decision, then the Contractor may within 90 days after receiving notice of such decision or within 90 days after the expiration of the first named period of 90 days (as the case may be) require that the matter or matters in dispute be referred to arbitration as hereinafter provided.

i) In case of contract where the contract price and/or contract value is less than Rs.5,00,00,000/- (Rupees Five Crore Only), any dispute arising out of or in connection with this contract, including any question regarding its existence, validity or termination, shall be referred to a mutually agreed arbitral tribunal in accordance with the Arbitration & Conciliation Act, 1996 (amended upto date). The arbitral tribunal shall consist of a sole arbitrator, as mutually agreed upon by the parties and the said dispute shall be finally resolved by the said arbitral tribunal. The decision of the arbitral tribunal shall be in writing (with reasons) and which will be final and binding upon the parties hereto and the expenses of the arbitration shall be paid as may be determined by the arbitral tribunal. The seat of the arbitration shall be Mumbai. The language of the arbitration shall be English.

If the parties fails to appoint mutually agreed arbitral tribunal, within the period of 30 days from the date of application seeking arbitration in the dispute, the arbitral tribunal shall be appointed by the recognised arbitral institution i.e. Mumbai Centre for International Arbitration (approved by Government of Maharashtra under G.R.No. ARB/Case No. 1/2017/D-19 dtd.28.02.2017) as per the Arbitration Rules of the Mumbai Centre for International Arbitration then in force ("MCIA Rules").

ii) In case of contract where the contract price and/or contract value is Rs.5,00,00,000/- (Rupees Five Crore Only) or more, any dispute arising out of or in connection with such a contract, including any question regarding its existence, validity or termination, shall be directly referred to & finally resolved by the recognised arbitral institution i.e. Mumbai Centre for International Arbitration (approved by Government of Maharashtra under G.R.No. ARB/Case No. 1/2017/D-19 dtd.28.02.2017) as per the Arbitration Rules of the Mumbai Centre for International Arbitration then in force ("MCIA Rules"). The arbitral tribunal shall consist of a sole arbitrator. The seat of the arbitration shall be Mumbai. The language of the arbitration shall be English.

In either case, the law governing this arbitration agreement and the contract shall be Indian Law.

**75 Copyright:**

The copyright of all drawings and other documents provided by the Contractor under the contract shall remain vested in the Contractor or his sub-contractors as the case may be the employer shall have a license to use such drawings and other documents in connection with the design, construction, operation, maintenance of the works. At any time the Employer shall have further license without additional payment to the Contractor to use any such drawings or documents for the purpose of making any improvement of the works or enlargement or duplication of any part thereof, provided that such improvement, enlargement, or duplication by itself or in conjunction

with any other improvements, enlargements or duplications already made in accordance with the further license does not result in the duplication of the whole works.

**76. Receipts to be signed in firm's name by any one of the partners:**

Every receipt for money which may become payable or for any security which may become transferable to the Contractor under these present shall, if signed in the partnership name by any one of the partners, be a good and sufficient discharge to the Commissioner and Municipal Corporation in respect of the money or security purporting to be acknowledged thereby, and in the event of death of any of the partners during the pendency of this contract, it is hereby expressly agreed that every receipt by any one of the surviving partners shall, if so signed as aforesaid, be good and sufficient discharge as aforesaid provided that nothing in this clause contained shall be deemed to prejudice or effect any claim which the Commissioner or the Corporation may hereafter have against the legal representatives of any partners so dying or in respect of any breach of any of the conditions thereof, provided also that nothing in this clause contained shall be deemed prejudicial or affect the respective rights or obligations of the Contractors and of the legal representatives of any deceased Contractors interest.

**77 Proprietary data**

All documents and other information supplied by the Authority or submitted by an Applicant to the Authority shall remain or become the property of the Authority. Applicants are to treat all information as strictly confidential and shall not use it for any purpose other than for preparation and submission of their Application. The Authority will not return any Application or any information provided along therewith.

**78 Correspondence with the Applicant**

Save and except as provided in this TENDER, the Authority shall not entertain any correspondence with any Applicant in relation to the acceptance or rejection of any Application.

**79 Price Variation Clause**

The Contractor shall be reimbursed or shall refund to the Corporation as the case may be the variation in the value of the work carried out from time to time, depending on whether the prices of material and labour as a whole rise or fall, and the method adopted for such computations shall be as given below, it being clearly understood that the contractor shall have no claim for being reimbursed on the ground that the price of a particular material or group of materials have risen beyond the limits of the presumptions made in the following paras, however, no price variations shall be made applicable for contracts upto 12 months:

- A) Controlled materials: Price variations shall be permitted in respect of these materials the price level of which is controlled by the Government or its agency. The rate ruling on the date of submission of the tender shall be considered as the basic price of such material for adjustment. Any variation in this rate shall be considered for reimbursement to the contractor or refund to be claimed from the contractor as the case may be. The contractor shall, for the purpose of adjustment submit in original the relevant documents from the suppliers.
- B) Labour and other materials: For the purpose of this contract and for allowing reimbursement of refund on account of variation of prices of (i) labour, and (ii) materials other than materials mentioned in A above, computation will be based on the formula enunciated below which is based on the presumptions that :
- i) The general price level of labour, rises or falls in proportion to the rise or fall of consumer price index number 9 (general) for working class in Mumbai.
  - ii) The general price level of materials rises or falls in proportion to rise or fall of whole-sale price index as published by 'Economic Adviser to Govt. of India'.
  - iii) And that the component of labour is to the extent of 30 percent of 88 percent and the component of materials is to the extent of 70 percent of 88 percent of the value of the work carried out. The remaining 12 percent being the presumptive profit of the contractor.

a) Formula for Labour component:

$$VL = \frac{(0.88 R) \times 30}{100} \times \frac{(I - IO)}{IO}$$

b) Formula for Material component :

$$VM = \frac{(0.88 R \times 70 - C)}{100} \times \frac{(W - WO)}{WO}$$

Where –

VL = Amount of price variation to be reimbursed or claimed as refund on account of general rise or fall of index referred to above.

I = Consumer Price Index number of working class for Mumbai (declared by the Commissioner of Labour and Director of Employment, Mumbai) applicable to the period under reference (base year ending 2004-05 as 100 i.e. new series of indices).

IO = Consumer price index number for working class for Mumbai (declared by the Commissioner of labour and Director of Employment, Mumbai) prevailing, on the day of 28 days prior to the date of submission of the tender.

VM = The amount of price variation to be reimbursed or claimed as refund on account of general rise or fall of wholesale price index for period under reference.

W = Average wholesale price index as published by Economic Adviser to Govt. of India applicable to the period under reference.

WO = Wholesale price index as stated above prevailing on the day of 28 days prior to the date of submission of the tender.

R = Total value of the work done during the period under reference as recorded in the Measurement Book excluding water charges and sewerage charges but including cost of excess in respect of item upto 50 percent

C = Total value of Controlled materials used for the works as recorded in Measurement Book and paid for at original basic rate plus the value of materials used .

- i) The quantity of the Controlled material adopted in working out the value of 'C' shall be inclusive of permitted wastages as / if mentioned in specifications.
- ii) The basic rate for the supply of controlled material shall be inclusive of all the components of cost of materials excluding transport charges incurred for bringing the material from place of delivery to the site.

Computations based on the above formula will be made for the period of each bill separately and reimbursement will be made to (when the result is plus) and refund will claimed from (when the result is minus) the contractor's next bill. The above formulae will be replaced by the formulae in Annexure-I as and when mentioned in special conditions of contract

The operative period of the contract for application of price variation shall mean the period commencing from the date of commencement of work mentioned in the work order and ending on the date when time allowed for the work order and ending on the date when time allowed for the work specified in the contract for work expires, taking into consideration, the extension of time, if any, for completion of the work granted by Engineer under the relevant clause of the conditions of contract in cases other than those where such extension is necessitated on account of default of the contractor.

The decision of the Engineer as regards the operative period of the contract shall be final and binding on the contractors.

- iii) Where there is no supply of controlled items to contractor the component 'C' shall be taken as zero.

- C) Adjustment after completion: If the Contractor fails to complete the works within the time for completion adjustment of prices thereafter until the date of completion of the works shall be made using either the indices or prices relating to the prescribed time for completion, or the current indices or prices whichever is more favorable to the employer, provided that if an extension of time is granted, the above provision shall apply only to adjustments made after the expiry of such extension of time.
- D) Price variation will be calculated similarly and separately for extra items and / or excess quantities and provisional sums calculated under Sub Clause 10 (b)A (i)&(ii) and Sub Clause 10 (b) B(ii) based on the above formula/formulae in Annexure-I as and when mentioned in Special conditions of contract; IO and WO being the indices applicable to the date on which the rates under Sub Clause 10 (a)A (i)&(ii) and Sub Clause 10 (a) B(iii) are fixed. No price variation shall be admissible for FAIR items created during execution.

**80. Maximum Price Variation shall be as follows:**

Time Period of Project	Maximum limit of Price Variation
Up to 12 months	No variation allowed
Above 12 months to 24 months	5%
<b>Above 24 months</b>	<b>10%</b>

**\*Approval of AMC/MC shall be obtained before invitation of tender in case of any changes in above.**

- Note: 1) The extension in time period for the projects originally estimated including monsoon results in change of price variation slabs as mentioned above i.e. from first slab to second slab or from second slab to third slab, then the maximum limit of original slab will prevail.**
- 2) Operative period shall mean original or extended time period of contract.**

**For example:**

Extension of Time period	Maximum Price Variation
If original period of 11 months <b>including</b> monsoon extends to 16. The operative period will be 11+5 months.	No variation allowed
If original period of 11 months <b>excluding</b> monsoon extends to 16. The operative period will be 11+5 months.	Maximum 5% variation allowed

Price Variation during Extended Period of Contract:

- (i) Extension Due To Modification & Extension for delay due to BMC :

The price variation for the period of extension granted shall be limited to the amount payable as per the Indices. In case the indices increases or decreases, above/below the indices applicable, to the last month of the original or extended period vide clause 8(l)(a)(i) and (ii) of standard GCC

(ii) Extension Of Time For Delay Due To Contractor:

(a) The price variation for the period of extension granted shall be limited to the amount payable as per the Indices in case the indices increase, above the indices applicable, to the last month of the original completion period or the extended period vide above clause 8(l)(a)(i) and (ii) of standard GCC.

(b) The price variation shall be limited to the amount payable as per the indices, in case the indices decrease or fall below the indices applicable, to the last month of original / extended period of completion period vide above clause 8(l)(b) of standard GCC, then lower indices shall be adopted.

(iii) Extension of Time for Delay due to reasons not attributable to BMC and Contractor (Reference Cl.8 (d) of Standard GCC):

The price variation for the period of extension granted shall be limited to the amount payable as per the Indices in case the indices increases or decreases, above/below the indices applicable, to the last month of the original period.

## **81. Payment:**

### **Interim Payment:**

i) Interim bills shall be submitted by the Contractor from time to time (but at an interval of not less than one month) for the works executed. The Engineer shall arrange to have the bill verified by taking or causing to be taken, where necessary, the requisite measurement of work.

ii) Payment on account for amount admissible shall be made on the Engineer certifying the sum to which the Contractor is considered entitled by way of interim payment for all the work executed, after deducting there from the amount already paid, the security deposit / retention money and such other amounts as may be deductible or recoverable in terms of the contract.

iii) On request, the contractor will be paid upto 75 percent of the value of the work carried out as an adhoc payment in the first week of next month after deducting there from recoveries on account of advances, interest, retention money, income tax etc. The balance payment due will be paid thereafter.

iv) No interim payment will be admitted until such time the Contractor have fully complied with the requirement of the Condition no.8 (g) and 8 (h) concerning submission and approval of Network Schedule for the works, as detailed in Condition 8 (h). A fixed sum shall be held in abeyance at the time of next interim payment for non-attainment of each milestone in the network and shall be released only on attainment of the said milestone.

v) An interim certificate given relating to work done or material delivered may be modified or corrected by a subsequent interim certificate or by the final certificate. No certificate of the Engineer supporting an interim payment shall of itself be conclusive evidence that any work or materials to which it relates is / are in accordance with the contract.

## **82 Banning/De-Registration of Agencies of Construction works in BMC**

- **The regulations regarding Demotion/ Suspension Banning for specific period or permanently / De-Registration shall be governed as per the respective condition in Contractor Registration Rules of BMC.**

## **83. JOINT VENTURE- (NOT APPLICABLE TO SUBJECT TENDER)**

**In case if Joint Venture is allowed for the Project, the guidelines for JV as follows shall be incorporated in the Tender Document:**

- a) Joint Venture should be allowed only when the number of identifiable different works is more than one and/or the estimated cost of tender is more than Rs.100 Crores. JV shall also be allowed for complex technical work below Rs.100 Crores with the approval of concerned AMC
- b) Separate identity/name shall be given to the Joint Venture firm.
- c) Number of members in a JV firm shall not be more than three in normal circumstances, if the work involves only one discipline (say Civil or Electrical). If number of members in JV is required to be more than three, then approval of concerned AMC needs to be sought.
- d) A member of JV firm shall not be permitted to participate either in individual capacity or as a member of another JV firm in the same tender.
- e) The tender form shall be purchased and submitted in the 'name of the JV firm or any constituent member of the JV.
- f) Normally EMD shall be submitted only in the name of the JV and not in the name of constituent member. However, EMD in the name of lead partner can be accepted subject to submission of specific request letter from lead partner stating the reasons for not submitting the EMD in the name of JV and giving written confirmation from the JV partners to the effect that the EMD submitted by the lead partner may be deemed as EMD submitted by JV firm.
- g) One of the members of the JV firm shall be the lead member of the JV firm who shall have a majority (at least 51%) share of interest in the JV firm. The other members shall have a share of not less than 20% each in case of JV firms with up to three members and not less than 10% each in case of JV firms with more than three members. In case of JV firm with foreign member(s), the lead member has to be an Indian firm with a minimum share of 51%.



- h) A copy of Letter of Intent or Memorandum of Understanding (MoU) executed by the JV members shall be submitted by the JV firm along with the tender. The complete details of the members of the JV firm, their share and responsibility in the JV firm etc. particularly with reference to financial technical and other obligation shall be furnished in the agreement.
- i) Once the tender is submitted, the agreement shall not be modified/alterd/terminated during the validity of the tender. In case the tenderer fails to observe/comply with this stipulation, the full Earnest Money Deposit (EMD) shall be forfeited. In case of successful tenderer, the validity of this agreement shall be extended till the currency of the contract expires.
- j) Approval for change of constitution of JV firm shall be at the sole discretion of the BMC. The constitution of the JV firm shall not be allowed to be modified after submission of the tender bid by the JV firm except when modification becomes inevitable due to succession laws etc. and in any case the minimum eligibility criteria should not get vitiated. In any case the Lead Member should continue to be the Lead Member of the JV firm. Failure to observe this requirement would render the offer invalid.
- k) Similarly, after the contract is awarded, the constitution of JV firm shall not be allowed to be altered during the currency of contract except when modification become inevitable due to succession laws etc. and in any case the minimum eligibility criteria should not get vitiated. Failure to observe this stipulation shall be deemed to be breach of contract with all consequential penal action as per contract condition.
- l) On award of contract to a JV firm, a single Performance Guarantee shall be required to be submitted by the JV firm as per tender conditions. All the Guarantees like Performance Guarantee, Bank Guarantee for Mobilization advance, machinery Advance etc. shall be accepted only in the name of the JV firm and no splitting of guarantees amongst the members of the JV firm shall be permitted.
- m) On issue of LOA, an agreement among the members of the JV firm (to whom the work has been awarded) has to be executed and got registered before the Registrar of the Companies under Companies Act or before the Registrar / Sub-Registrar under the Registration Act, 1908. This agreement shall be submitted by the JV firm to the BMC before signing the contract agreement for the work. (This agreement format should invariably be part of the tender condition). In case the tenderer fails to observe/comply with this stipulation, the full Earnest Money Deposit (EMD) shall be forfeited and other penal actions due shall be taken against partners of the JV and the JV. This joint venture agreement shall have, inter-alia, following clauses:-
- i. **Joint and several liability** - The members of the JV firm to which the contract is awarded, shall be jointly and severally liable to the Employer (BMC) for execution of the project in accordance with General and Special conditions of the contract. The JV members shall also be liable jointly and severally for the loss, damages caused to the BMC during the course of execution of the contract or due to no execution of the contract or part thereof.
  - ii. **Duration of the Joint Venture Agreement** -It shall be valid during the entire period of the contract including the period of extension if any and the maintenance period after the work is completed.
  - iii. **Governing Laws** - The Joint Venture Agreement shall in all respect be governed by and interpreted in accordance with Indian Laws.
  - iv. **Authorized Member** -Joint Venture members shall authorize one of the members on behalf of the Joint Venture firm to deal with the tender, sign the agreement or enter into contract in respect of the said tender, to receive payment, to witness joint measurement of work done, to sign mea-

surement books and similar such action in respect of the said tender/contract. All notices/correspondences with respect to the contract would be sent only to this authorized member of the JV firm.

No member of the Joint Venture firm shall have the right to assign or transfer the interest right or liability in the contract without the written consent of the other members and that of the employer in respect of the said tender/contract.

**n. Documents to be enclosed by the JV firm along with the tender:**

- i. In case one or more of the members of the JV firm is/are partnership firm(s), following documents shall be submitted:
  - a. Notary certified copy of the Partnership Deed,
  - b. Consent of all the partners to enter into the Joint Venture Agreement on a stamp paper of appropriate value (in original).
  - c. Power of Attorney (duly registered as per prevailing law) in favor of one of the partners to sign the MOU and JV Agreement on behalf of the partners and create liability against the firm.
- ii. In case one or more members is/are Proprietary Firm or HUF, the following documents shall be enclosed:
  - a. Affidavit on Stamp Paper of appropriate value declaring that his Concern is a Proprietary Concern and he is sole proprietor of the Concern OR he is in position of "KAR-TA" of Hindu Undivided Family and he has the authority, power and consent given by other partners to act on behalf of HUF.
- iii. In case one or more members is/are limited companies, the following documents shall be submitted:
  - a. Notary certified copy of resolutions of the Directors of the Company, permitting the company to enter into a JV agreement, authorizing MD or one of the Directors or Managers of the Company to sign MOU, JV Agreement, such other documents required to be signed on behalf of the Company and enter into liability against the company and/or do any other act on behalf of the company.
  - b. Copy of Memorandum and articles of Association of the Company.
  - c. Power of Attorney (duly registered as per prevailing law) by the Company authorizing the person to do/act mentioned in the para (a) above.
- o. All the members of the JV shall certify that they have not been black listed or debarred by BMC from participation in tenders/contract in the past either in their individual capacity or the JV firm or partnership firm in which they were members / partners.
- p. Credentials & Qualifying criteria: Technical and financial eligibility of the JV firm shall be adjudged based on satisfactory fulfillment of the following criteria:

**Technical eligibility criteria:** In case of Work involving single discipline, the Lead member of the JV firm shall meet at least 35% requirement of technical capacity as stipulated in tender document.

OR

In case of composite works (e.g. works involving more than one distinct component such as Civil Engineering works, M&E works, Electrical works, etc. and in the case of major bridges, substructure and superstructure etc.), at least one member should have satisfactorily completed 35% of the value of any one component of the project work so as to cover all the components of project work or any member having satisfactorily completed 35% of the value of work of each component during last seven financial years.

**In such cases, what constitutes a component in a composite work shall be clearly defined as part of the tender condition without any ambiguity.**

**Financial eligibility criteria:** The contractual payments received by the JV firm or the arithmetic sum of contractual payments received by all the members of JV firm in any one of the previous three financial years and shall be at least **100% of the estimated value** of the work as mentioned in the tender.

#### **84. Compensation for delay:**

If the Contractor fails to complete the works and clear the site on or before the Contract or extended date(s) / period(s) of completion, he shall, without prejudice to any other right or remedy of Municipal Corporation on account of such breach, pay as agreed compensation, amount calculated as stipulated below (or such smaller amount as may be fixed by the Engineer) on the contract value of the whole work or on the contract value of the time or group of items of work for which separate period of completion are given in the contract and of which completion is delayed for every week that the whole of the work of item or group of items of work concerned remains uncompleted, even though the contract as a whole be completed by the contract or the extended date of completion. For this purpose the term 'Contract Value' shall be the value of the work at Contract Rates as ordered including the value of all deviations ordered:

- Completion period for projects (originally stipulated or as extended) not exceeding 6 months: **to the extent of maximum 1 percent per week.**
- Completion period for projects (originally stipulated or as extended) exceeding 6 months and not exceeding 2 years: **to the extent of maximum ½ percent per week.**
- Completion period for projects (originally stipulated or as extended) exceeding 2 years: **to the extent of maximum ¼ percent per week.**

When the delay is not a full week or in multiple of a week but involves a fraction of a week the compensation payable for that fraction shall be proportional to the number of days involved.

Provided always that the total amount of compensation for delay to be paid this condition shall not exceed the undernoted percentage of the Contract Value of the item or group of items of work for which a separate period of completion is given.

- i) Completion period (as originally stipulated or as extended) not exceeding 6 months: **10 percent.**
- ii) Completion period (as originally stipulated or as extended) exceeding 6 months and not exceeding 2 years: **7½ percent.**
- iii) Completion period (as originally stipulated or as extended) exceeding 2 years: **5 percent.**

The amount of compensation may be adjusted set off against any sum payable to the contractor under this or any other contract with the Municipal Corporation.

#### **85. Action and Compensation Payable In Case Of Bad Work and Not Done As Per Specifications**

All works under or in course of execution or executed in pursuance of the contract, shall at all times be open and accessible to the inspection and supervision of the Engineer-in-charge, his authorized subordinates in charge of the work and all the superior officers, officer of the Vigilance Department of the BMC or any organization engaged by the BMC for Quality Assurance and the contractor shall, at all times, during the usual working hours and at all other times at which reasonable notice of the visit of such officers has been given to the contractor, either himself be present to receive orders and

instructions or have a responsible agent duly accredited in writing, present for that purpose. Orders given to the Contractor's agent shall be considered to have the same force as if they had been given to the contractor himself.

If it shall appear to the Engineer-in-charge or his authorized subordinates in-charge of the work or to the officer of Vigilance Department, that any work has been executed with unsound, imperfect or unskillful workmanship or with materials of any inferior description, or that any materials or articles provided by him for the execution of the work are unsound or of a quality inferior to that contracted for or otherwise not in accordance with the contract, the contractor shall, on demand in writing which shall be made within twelve months of the completion of the work from the Engineer-in-Charge specifying the work, materials or articles complained of notwithstanding that the same may have been passed, certified and paid for forthwith rectify, or remove and reconstruct the work so specified in whole or in part, as the case may require or as the case may be, remove the materials or articles so specified and provide other proper and suitable materials or articles at his own charge and cost. In the event of the failing to do so within a period specified by the Engineer-in-Charge in his demand aforesaid, then the contractor shall be liable to pay compensation at the same rate as under clause 8.e. of the general condition of contract in section 9 of tender document (for Compensation for delay) for this default. In such case the Engineer-in Charge may not accept the item of work at the rates applicable under the contract but may accept such items at reduced rates as the Engineer in charge may consider reasonable during the preparation of on account bills or final bill if the item is so acceptable without detriment to the safety and utility of the item and the structure or he may reject the work outright without any payment and/or get it and other connected and incidental items rectified, or removed and re-executed at the risk and cost of the contractor. Decision of the Engineer-in-Charge to be conveyed in writing in respect of the same will be final and binding on the contractor.

If the penalisation amount exceeds maximum limit with respect to Clause 8.e of Standard General Conditions of Contract, then a show cause notice shall necessarily be issued to the contract as to why the contract should not be terminated.

**86. Contractors remain liable to pay compensation:**

In any case in which any of the powers conferred upon the Engineer In-charge by the **relevant clauses** in documents that form a part of contract as exercised or is exercisable in the event of any future case of default by the Contractor, he is declared liable to pay compensation amounting to the whole of his security deposit. The liability of the Contractor for past and future compensation shall remain unaffected.

In the event of the Executive Engineer taking action against these **relevant clauses**, he may, if he so desires, take possession of all or any tools and plant, materials and stores in or upon the work of site thereof or belonging to the Contractor or procured by him and intended to be used for the execution of the work or any part thereof paying or allowing for the same in account at the contract rates, or in the case of contract rates not being applicable at current market rates to be certified by the Executive Engineer, may after giving notice in writing to the Contractor or his staff of the work or other authorized agent require him to remove such tools and plants, materials or stores from the premises within a time to be specified in such notice and in the event of the Contractor failing to comply with any such requisition, the Executive Engineer may remove them at the contractors expense of sell them by auction or private sell on account of the Contractor at his risk in all respects and certificate of the Executive Engineer as to the expense of any such

removal and the amount of the proceeds an expense of any such sell be final and conclusive against the Contractor.

**87. No Claim to Any Payment or Compensation or Alteration in or Restriction of Work**

(a) If at any time after the execution of contract documents, the Engineer shall for any reason whatsoever, desires that the whole or any part of the works specified in the Tender should be suspended for any period or that the whole or part of the work should not be carried out, at all, he shall give to the Contractor a Notice in writing of such desire and upon the receipt of such notice, the Contractor shall forthwith suspend or stop the work wholly or in part as required after having due regard to the appropriate stage at which the work should be stopped or suspended so as not to cause any damage or injury the work already done or endanger the safety thereof, provided that the decision of the Engineer as to the stage at which the work or any part of it could be or could have been safely stopped or suspended shall be final and conclusive against the contractor.

The Contractor shall have no claim to any payment or compensation whatsoever by reason of or in pursuance of any notice as aforesaid, on account of any suspension, stoppage or curtailment except to the extent specified hereinafter.

(b) Where the total suspension of Work Order as aforesaid continued for a continuous period exceeding 90 days the contractor shall be at liberty to withdraw from the contractual obligations under the contract so far as it pertains to the unexecuted part of the work by giving 10 days prior notice in writing to the Engineer within 30 days of the expiry of the said period of 90 days, of such intention and requiring the Engineering to record the final measurement of the work already done and to pay final bill. Upon giving such Notice, the Contractor shall be deemed to have been discharged from his obligations to complete the remaining unexecuted work under his contract. On receipt of such notice the Engineer shall proceed to complete the measurement and make such payment as may be finally due to the contractor within a period of 90 days from the receipt of such Notice in respect of the work already done by the contractor. Such payment shall not in any manner prejudice the right of the contractor to any further compensation under the remaining provisions of this clause.

(c) Where the Engineer required to Contractor to suspend the work for a period in excess of 30 days at any time or 60 days in the aggregate, the Contractor shall be entitled to apply to the Engineer within 30 days of the resumption of the work after such suspension for payment of compensation to the extent of pecuniary loss suffered by him in respect of working machinery remained ideal on the site of on the account of his having an to pay the salary of wages and labour engaged by him during the said period of suspension provided always that the contractor shall not be entitled to any claim in respect of any such working machinery, salary or wages for the first 30 days whether consecutive or in the aggregate or such suspension or in respect of any such suspension whatsoever occasion by unsatisfactory work or any other default on his part, the decision of the Engineer in this regard shall be final and conclusive against the contractor.

**88. Contractor to supply plant, ladder, scaffolding, etc and is liable for damages arising from non provision of lights, fencing, etc.**

The Contractor shall supply at his own cost all material, plant, tools, appliances, implements, ladders, cordage, tackle scaffolding and temporary works requisite or proper for the proper execution of the work, whether, in the original altered or substituted form and whether included in the specification of other documents forming part of the contract or referred to in these conditions or not and which may be necessary for the purpose of satisfying or complying with the requirements of the Eng-In-Charge as to any matter as to which under these conditions is entitled to be satisfied, or which is entitled to

require together with the carriage therefore to and from the work.

The Contractor shall also supply without charge, the requisite number of person with the means and materials necessary for the purpose of setting out works and counting, weighing and assisting in the measurements of examination at any time and from time to time of the work or materials, failing which the same may be provided by the Engineer In-charge at the expense of the contractor and the expenses may be deducted from any money due to the contractor under the contract or from his security deposit or the proceeds of sale thereof, or offers sufficient portion thereof.

The contractor shall provide all necessary fencing and lights required to protect the public from accident and shall also be bound to bear the expenses of defence of every suit, action or other legal proceedings, that may be brought by any person for injury sustained owing to neglect of the above precautions and to pay any damages and cost which may be awarded in any such suit action or proceedings to any such person or which may with the consent of the contractor be paid for compromising any claim by any such person.

**89. Prevention of Fire:**

The contractor shall not set fire to any standing jungle, trees, brushwood or grass without a written permit from the Engineer In-charge. When such permit is given, and also in all cases when destroying cut or dug up trees brushwood, grass, etc., by fire, the contractor shall take necessary measure to prevent such fire spreading to or otherwise damaging surrounding property. The Contractor shall make his own arrangements for drinking water for the labour employed by him.

**90.** Compensation for all damages done intentionally or unintentionally by contractor's labour whether in or beyond the limits of BMC property including any damage caused by spreading the fire shall be estimated by the Engineer In-charge or such other officer as he may appoint and the estimate of the Engineer in-charge to the decision of the Dy. Chief Engineer on appeal shall be final and the contractor shall be bound to pay the amount of the assessed compensation on demand failing which the same will be recovered from the Contractor as damages or deducted by the Engineer In-charge from any sums that may be due or become due from BMC to contractor under this Contract or otherwise. Contractor shall bear the expenses of defending any action or other legal proceedings that may be brought to prevent the spread of fire and he shall pay any damages and costs that may be awarded by the Court in consequence.

**91.** In the case of Tender by partners, any change in the constitution of the firm shall be forthwith, notified by the contractor through the Engineer In-charge for his information.

**92. Action where no specifications:**

In the case of any class of work for which there is no such specifications, such works shall be carried out in accordance with the specifications and in the event of there being no such specifications, then in such case, the work shall be carried out in all respects in accordance with all instructions and requirements of the Engineer In-charge.

**93. Safety and medical help:**

(i) The Contractor shall be responsible for and shall pay the expenses of providing medical help to any workmen who may suffer a bodily injury as a result of an accident. If such expenses are incurred by BMC, the same shall be recoverable from the contractor forthwith and be included without prejudice to any other remedy of BMC from any amount due or that may become due to the Contractor.

- (ii) The contractor shall provide necessary personal safety equipment and first-aid box for the use of persons employed on the site and shall maintain the same in condition suitable for immediate use at any time.
- (iii) The workers shall be required to use the safety equipments so provided by the contractor and the contractor shall take adequate steps to ensure the proper use of equipments by those concerned.
- (iv) When the work is carried on in proximity to any place where there is risk or drawing all necessary equipments shall be provided and kept ready for use and all necessary steps shall be taken for the prompt rescue of any person in danger.

94. No compensation shall be allowed for any delay caused in the starting of the work on account of acquisition of land or in the case of clearance of works, on account of ant delay in according to sanction of estimates.

**95. Anti-malaria and other health measures:**

Anti-Malaria and other health measures shall be taken as directed by the Executive Health Officer of BMC. Contractor shall see that mosquitogenic conditions are created so as to keep vector population to minimum level. Contractor shall carry out anti-malaria measures in the area as per the guidelines issued by the Executive Health Officer of BMC from time to time.

In case of default, in carrying out prescribed anti-malaria measures resulting in increase in malaria incidence, contractor shall be liable to pay BMC on anti-malaria measures to control the situation in addition to fine.

96. Tender shall note that policy guidelines issued under Hon'ble M.C.'s Circular Vide No. MBC/6913 dated 05.05.2020 for engaging labour for providing reservation shall be applicable to the contract work under reference. **(Copy of the circular at page 262-263).**





**SECTION 10**  
**SPECIFICATIONS**  
**& SELECTION OF MATERIAL**



**10.1 SPECIFICATIONS & SELECTION OF MATERIAL**

The tender is prepared on the basis of Unified Schedule of Rates and specifications 2023. The specifications of the items of USOR are available on BMC portal <http://portal.mcgm.gov.in> under the Tender tab. Hence the deserving contractor shall either download the same from BMC portal or the same may be collected in the soft copy format at the time of purchasing the tender from this office.

**10.2 SELECTION OF MATERIAL**

1. All materials brought on the site of work and meant to be used in the same, shall be the best of their respective kinds and to the approval of the Engineer. The Engineer or his representative will accept that the materials are really the best of their kinds, when it is proved beyond doubt that no better materials of the particular kind in question are available in the market.
2. The contractor shall obtain the approval of the Engineer of samples of all materials to be used in the works and shall deposit these samples with him before placing an order for the materials with the suppliers. The materials brought on the works shall conform in every respect to their approved samples. Fresh samples shall be deposited with the Engineer whenever the type or source of any material changes.
3. The contractor shall check each fresh consignment of materials as it is brought to the site of works to see that they conform in all respects to the Specifications of the samples approved by the Engineer, or both.
4. The Engineer will have the option to have any of the materials tested to find out whether they are in accordance with the Specifications and the Contractor will bear all expenses for such testing. All B bills, vouchers and test certificates, which in the opinion of the Engineer or his representative are necessary to convince him as to the quality of the materials or their suitability shall be produced for his inspection when required.
5. Any materials that have not been found to conform to the specifications will be rejected forthwith and shall be removed from the site by the contractor at his own cost within 24 hours.
6. The Engineer shall have power to cause the Contractors to purchase and use such materials from any particular source, as may in his opinion be necessary for the proper execution of the work.
7. Notwithstanding the source, the sand shall be washed using sand washing machine before use.



**SECTION 11**

**FRAUD**

**AND**

**CORRUPT**

**PRACTICES**



## **FRAUD AND CORRUPT PRACTICES**

- The Applicants and their respective officers, employees, agents and advisers shall observe the highest standard of ethics during the Bidding Process. Notwithstanding anything to the contrary contained herein, the Authority may reject an application without being liable in any manner whatsoever to the Applicant if it determines that the Applicant has, directly or indirectly or through an agent, engaged in corrupt practice, fraudulent practice, coercive practice, undesirable practice or restrictive practice in the Bidding Process.
- Without prejudice to the rights of the Authority under relevant Clause hereinabove, if an Applicant is found by the Authority to have directly or indirectly or through an agent, engaged or indulged in any corrupt practice, fraudulent practice, coercive practice, undesirable practice or restrictive practice during the Bidding Process, such Applicant shall not be eligible to participate in any tender or RFQ issued by the Authority during a period of 2 (two) years from the date such Applicant is found by the Authority to have directly or indirectly or through an agent, engaged or indulged in any corrupt practice, fraudulent practice, coercive practice, undesirable practice or restrictive practice, as the case may be.
- For the purposes of this Clause, the following terms shall have the meaning hereinafter respectively assigned to them:
  - A. **“corrupt practice”** means the offering, giving, receiving, or soliciting, directly or indirectly, of anything of value to influence the actions of any person connected with the Bidding Process (for avoidance of doubt, offering of employment to, or employing, or engaging in any manner whatsoever, directly or indirectly, any official of the Authority who is or has been associated in any manner, directly or indirectly, with the Bidding Process or the LOA or has dealt with matters concerning the Concession Agreement or arising there from, before or after the execution thereof, at any time prior to the expiry of one year from the date such official resigns or retires from or otherwise ceases to be in the service of the Authority, shall be deemed to constitute influencing

the actions of a person connected with the Bidding Process); or

save and except as permitted under the relevant sub clause, engaging in any manner whatsoever, whether during the Bidding Process or after the issue of the LOA or after the execution of the Concession Agreement, as the case may be, any person in respect of any matter relating to the Project or the LOA or the Concession Agreement, who at any time has been or is a legal, financial or technical adviser of the Authority in relation to any matter concerning the Project;

- B. “fraudulent practice”** means a misrepresentation or omission of facts or suppression of facts or disclosure of incomplete facts, in order to influence the Bidding Process ;
- C. “coercive practice”** means impairing or harming or threatening to impair or harm, directly or indirectly, any person or property to influence any persons participation or action in the Bidding Process;
- D. “undesirable practice”** means (i) establishing contact with any person connected with or employed or engaged by the Authority with the objective of canvassing, lobbying or in any manner influencing or attempting to influence the Bidding Process; or (ii) having a Conflict of Interest; and
- E. “Restrictive practice”** means forming a cartel or arriving at any understanding or arrangement among Applicants with the objective of restricting or manipulating a full and fair competition in the Bidding Process.
- F.** If the Employer/Financier determines that the Contractor has engaged in corrupt, fraudulent, collusive, coercive or obstructive practices, in competing for or in executing the Contract, then the Employer may, after giving 14 days’ notice to the Contractor, terminate the Contractor's employment under the Contract and expel him from the Site, and the provisions of relevant Clause shall apply as if such expulsion had been made.



- G.** Should any employee of the Contractor be determined to have engaged in corrupt, fraudulent, collusive, coercive, or obstructive practice during the execution of the Works, then that employee shall be removed in accordance with relevant Clause.

For the purposes of this Sub-Clause:

- i. “corrupt practice” is the offering, giving, receiving to soliciting, directly or indirectly, of anything of value to influence improperly the actions of another party;
- ii. “Another party” refers to a public official acting in relation to the procurement process or contract execution. In this context, “public official” includes Financer staff and employees of other organizations taking or reviewing procurement decisions.
- iii. “fraudulent practice” is any act or omission, including a misrepresentation, that knowingly or recklessly misleads, or attempts to mislead, a party to obtain a financial or other benefit or to avoid an obligation;
- iv. “collusive practice” is an arrangement between two or more parties designed to achieve an improper purpose, including to influence improperly the actions of another party;
- v. “coercive practice” is impairing or harming, or threatening to impair or harm, directly or indirectly, any party or the property of the party to influence improperly the actions of a party;
- vi. “obstructive practice” is deliberately destroying, falsifying, altering or concealing of evidence material to the investigation or making false statements to investigators in order to materially impede the Financier investigation into allegations of a corrupt, fraudulent, coercive or collusive practice; and/or threatening, harassing or intimidating any party to prevent it from disclosing its knowledge of matters relevant to the investigation or from pursuing the investigation; or

- vii. Acts intended to materially impede the exercise of the Financer’s inspection and audit rights provided.
- viii. “party” refers to a public official; the terms “benefit” and “obligation” relate to the procurement process or contract execution; and the “act or omission” is intended to influence the procurement process or contract execution.
- ix. ”parties” refers to participants in the procurement process (including public officials) attempting to establish bid prices at artificial, noncompetitive levels.
- x. A “party” refers to a participant in the procurement process or contract execution.

**SECTION 12**

**PRE-BID MEETING**



## **PRE-BID MEETING**

Pre-bid meeting of the interested parties shall be convened at the designated date, time and place. A maximum of three representatives of each Applicant shall be allowed to participate on production of authority letter from the Applicant.

During the course of Pre-bid meeting, the Applicants will be free to seek clarifications and make suggestions for consideration of the Authority. The Authority shall Endeavour to provide clarifications and such further information as it may, in its sole discretion, consider appropriate for facilitating a fair, transparent and competitive Bidding Process.

### **6.9.1 Interpretation of e-Tender Document:**

- a) Tenderer(s) shall examine the tender document and acquaint themselves to all conditions and matters affecting the cost of the works. If any tenderer(s) finds discrepancies or omissions in the Document or if in doubt about their meaning, he should address a query during pre-bid meeting.
- b) Any resulting interpretation of the tender document will be issued to tenderer(s) as an addendum. Verbal clarification obtained from any source shall not be binding on the Corporation.
- c) No tenderer(s) shall amend the text of any document except as may be necessary to comply with any addendum.

### **6.9.2 Clarification of e-Tendering Documents**

Pre-bid meeting (If proposed as per e-Tender notice)

- a) The tenderer or his authorized representative is allowed to attend a pre-bid meeting as per the date, time and venue mentioned in the tender notice/header data.
- b) The purpose of the pre-bid meeting will be to clarify issues and to answer questions on any matter that may be raised prior to the pre-bid meeting.
- c) Any tenderer requiring any clarification of the tender document and/or the works may submit his questions on E.E.W.W.(Const)City's e-mail i.e. [eeconstcity.he@mcgm.gov.in](mailto:eeconstcity.he@mcgm.gov.in) Please note that all emails which will reach the inbox on or before 19.09.2024 till 5.00 p.m. will be considered for pre-bid meeting.



**SECTION – 13**  
**LIST OF APPROVED BANKS**





## LIST OF APPROVED BANKS

1. The following Banks with their branches in Greater Mumbai and in suburbs and extended suburbs up to Virar and Kalyan have been approved only for the purpose of accepting Banker's guarantee from 1997-98 onwards until further instructions.
2. The Bankers Guarantee issued by branches of approved Banks beyond Kalyan and Virar can be accepted only if the said Banker's Guarantee is countersigned by the Manager of a branch of the same Bank, within the Mumbai Limit categorically endorsing thereon that said Bankers Guarantee is binding on the endorsing Branch of the bank within Mumbai limits and is liable to be enforced against the said branch of the Bank in case of default by the contractor/supplier furnishing the Bankers Guarantee.

### List of approved Banks:-

<b>A</b>	<b>S.B.I and its subsidiary Banks</b>
1	State Bank Of India.
2	<del>State Bank Of Bikaner &amp; Jaipur.</del>
3	State Bank Of Hyderabad.
4	State Bank Of Mysore.
5	State Bank Of Patiala.
6	State Bank Of Saurashtra.
7	State Bank Of Travankore.
<b>B</b>	<b>Nationalized Banks</b>
8	Allahabad Bank.
9	Andhra Bank.
10	Bank Of Baroda.
11	Bank Of India.

12	Bank Of Maharashtra.
13	Central Bank Of India.
14	Dena Bank.
15	Indian Bank.
16	Indian Overseas Bank.
17	Oriental Bank Of Commerce.
18	Punjab National Bank.
19	Punjab & Sindh Bank.
20	Syndicate Bank.
21	Union Bank Of India.
22	United Bank Of India.
23	UCO Bank.
24	Vijaya Bank.
24A	Corporation Bank.
<b>C</b>	<b>Scheduled Commercial Banks</b>
25	Bank Of Madura Ltd.
26	Bank Of Rajasthan Ltd.
27	Banaras State Bank Ltd.
28	Bharat Overseas Bank Ltd
29	Catholic Syrian Bank Ltd.
30	City Union Bank Ltd.

31	Development Credit Bank.
32	Dhanalakshmi Bank Ltd.
33	Federal Bank Ltd.
34	Indusind Bank Ltd.
35	I.C.I.C.I Banking Corporation Ltd.
36	Global Trust Bank Ltd.
37	Jammu & Kashmir Bank Ltd.
38	Karnataka Bank Ltd.
39	KarurVysya Bank Ltd.
40	Laxmi Vilas Bank Ltd.
41	Nedugundi Bank Ltd.
42	Ratnakar Bank Ltd.
43	Sangli Bank Ltd.
44	South Indian Bank Ltd.
45	S.B.I Corporation &Int Bank Ltd.
46	Tamilnadu Mercantile Bank Ltd.
47	United Western Bank Ltd.
48	Vysya Bank Ltd.
<b>D</b>	<b>Schedule Urban Co-op Banks</b>
49	Abhyudaya Co-op Bank Ltd.
50	Bassein Catholic Co-op Bank Ltd.

51	Bharat Co-op Bank Ltd.
52	Bombay Mercantile Co-op Bank Ltd.
53	Cosmos Co-op Bank Ltd.
54	Greater Mumbai Co-op Bank Ltd.
55	JanataSahakari Bank Ltd.
56	Mumbai District Central Co-op Bank Ltd.
57	Maharashtra State Co-op Bank Ltd.
58	New India Co-op Bank Ltd.
59	North Canara G.S.B. Co-op Bank Ltd.
60	Rupee Co-op Bank Ltd.
61	Sangli Urban Co-op Bank Ltd.
62	Saraswat Co-op Bank Ltd.
63	ShamraoVithal Co-op Bank Ltd.
64	Mahanagar Co-op Bank Ltd.
65	Citizen Bank Ltd.
66	Yes Bank Ltd.
<b>E</b>	<b>Foreign Banks</b>
67	ABM AMRO (N.Y.) Bank.
68	American Express Bank Ltd.
69	ANZ Grindlays Bank Ltd.
70	Bank Of America N.T. & S.A.

71	Bank Of Tokyo Ltd.
72	Bankindosuez.
73	BanqueNationale de Paris.
74	Barclays bank.
75	City Bank N.A.
76	Hongkong& Shanghai banking Corporation.
77	Mitsui Taiyokbe Bank Ltd.
78	Standard Chartered Bank.
79	Cho Hung Bank.

**Note : Please refer Circular u/n CA/FBK/241 dtd. 27.11.2019 attached at Pg.293**



**SECTION – 14**  
**APPENDIX**

**FORM OF TENDER**

To,  
The Municipal Commissioner for Greater Mumbai  
Sir,

I/ We have read and examined the following documents relating to the construction of

- 
- i. Notice inviting tender.
  - ii. Directions to tenderers (General and special)
  - iii. General condition of contract for Civil Works of the Brihanmumbai Municipal Corporation 2016 as applicable.
  - iv. Relevant drawings
  - v. Specifications.
  - vi. Special directions
  - vii. Annexure A, B, C, E & I.
  - viii. Bill of Quantities and Rates.

1A. I/We \_\_\_\_\_  
(full name in capital letters, starting with surname), the Proprietor/ Managing Partner/ Managing Director/ Holder of the Business, for the establishment / firm / registered company, named herein below, do hereby offer to .....

.....  
.....  
Referred to in the specifications and schedule to the accompanying form of contract of the rates entered in the schedule of rates sent herewith and signed by me/ us” (strike out the portions which are not applicable).

1B. I/We do here by state and declare that I/We, whose names are given herein below in details with the addresses, have not filled in this tender under any other name or under the name of any other establishment /firm or otherwise, nor are we in any way related or concerned with the establishment /firm or any other person, who have filled in the tender for the aforesaid work.”

2. I/We hereby tender for the execution of the works referred to in the aforesaid documents, upon the terms and conditions, contained or referred to therein and in accordance with the specifications designs, drawings and other relevant details in all respects.

\* At the rates entered in the aforesaid Bill of Quantities and Rates.

3. According to your requirements for payment of Earnest Money amounting to Rs. \_\_\_\_\_ /-(Rs. \_\_\_\_\_ )

I/We have deposited the amount through online payment gateways with the C.E. of the Corporation not to bear interest

4. I/We hereby request you not to enter into a contract with any other person/s for the execution of the works until notice of non/acceptance of this tender has first been communicated to me/us, and in consideration of yours agreeing to refrain from so doing I/we agree not to withdraw the offer constituted by this tender before the date of communication to me/us of such notice of non/acceptance, which date shall be not later than ten days from the date of the decision of the Standing Committee or Education Committee of the Corporation, as maybe required under the Mumbai Municipal Corporation Act, not to accept this tender.(Subject to condition 5 below).



- 5. I/We also agree to keep this tender open for acceptance for a period of 180 days from the date fixed for opening the same and not to make any modifications in its terms and conditions which are not acceptable to the Corporation.
- 6. I/We agree that the Corporation shall, without prejudice to any other right or remedy, be at liberty to forfeit the said earnest money absolutely, if.
  - a. I/We fail to keep the tender open as aforesaid.
  - b. I/We fail to execute the formal contract or make the contract deposit when called upon to do so.
  - c. I/we do not commence the work on or before the date specified by the Engineer in his work order.
- 7. I/We hereby further agree to pay all the charges of whatsoever nature in connection with the preparation, stamping and execution of the said contract.
- 8. I/We further agree that, I/we shall register ourselves as ‘Employer’ with the Bombay Iron and Steel Labour Board’ and fulfil all the obligatory provisions of Maharashtra Mathadi, Hamal and other Manual workers (Regulation of Employment and Welfare) Act 1969 and the Bombay Iron and Steel unprotected workers Scheme 1970.
- 9. “I/We..... have failed in the accompanying tender with full knowledge of liabilities and, therefore, we will not raise any objection or dispute in any manner relating to any action, including forfeiture of deposit and blacklisting, for giving any information, which is found to be incorrect and against the instructions and directions given in this tender.
- 10. “I/We further agree and undertake that in the event it is revealed subsequently after the allotment of work/contract to me/us, that any information given by me/us in this tender is false or incorrect, I/We shall compensate the Brihanmumbai Municipal Corporation for any such losses or inconvenience caused to the Corporation in any manner and will not resist any claim for such compensation on any ground whatsoever. I/we agree and undertake that I/we shall not claim in such case any amount by way of damages or compensation for cancellation of the contract given to me/us or any work assigned to me/us or is withdrawn by the Corporation,”

Address

Yours faithfully,

.....  
.....

Digital Signature of the Tenderer or the Firm

- 1.....
- 2.....
- 3.....
- 4.....
- 5.....

Full Name and private residential address of all the partners constituting the Firm

A/c No.

- 1. ....
- 2. ....
- 3. ....
- 4. ....
- 5. ....

.....

Name of Bank

Name of Branch

Vender No. ....

**AGREEMENT FORM**

Tender / Quotation dated ..... 20...

Standing Committee/ Education Committee Resolution No.  
.....CONTRACT FOR THE WORKS

This agreement made this day of .....  
Two thousand ..... Be-  
tween .....

inhabitants of Mumbai, carrying on business at.....  
in Bombay under the style and name of Messrs .....  
(Hereinafter called "the contractor of the one part and Shri .....

the D.M.C.(S.E.) (hereinafter called "the commissioner" in which expression are included unless the inclusion is inconsistent with the context, or meaning thereof, his successor or successors for the time being holding the office of D.M.C.(S.E.) of the second part and the Brihanmumbai Municipal Corporation(hereinafter called "the Corporation") of the third part, WHEREAS the contractor has tendered for the construction, completion and maintenance of the works described above and his tender has been accepted by the Commissioner (with the approval of the Standing Committee/Education Committee of the Corporation NOW THIS

THIS AGREEMENT WITNESSETH as follows:-

- 1) In this agreement words and expressions shall have the same meanings as are respectively assigned to them in the General Conditions of Contract for works hereinafter referred to:-
- 2) The following documents shall be deemed to form and be read and constructed as a part of this agreement viz.
  - b) The letter of Acceptance
  - c) The Bid:
  - d) Addendum to Bid; if any
  - e) Tender Document
  - f) The Bill of Quantities:
  - g) The Specification:
  - h) Detailed Engineering Drawings
  - i) Standard General Conditions of Contracts (GCC) as applicable (2016)
  - j) All correspondence documents between bidder and BMC
- 3) In consideration of the payments to be made by the Commissioner to the contractor as hereinafter mentioned the contractor hereby covenants with the Commissioner to construct, complete and maintain the works in conformity in all respects with the provision of the contract.

4) The Commissioner hereby covenants to pay to the Contractor in consideration of the construction, completion and maintenance of the works the contract sum, at times and in the manner prescribed by the contract.

IN WITNESS WHERE OF the parties hereto have caused their respective common seals to be herein to affixed (or have hereunto set their respective hands and seals) the day and year above written.

Signed, Sealed and delivered by the contractors

\_\_\_\_\_  
\_\_\_\_\_  
\_\_\_\_\_

In the presence of

Trading under the name and style of

\_\_\_\_\_  
\_\_\_\_\_

Full Name  
Address

Signed by the DMC(SE) in the presence of

\_\_\_\_\_  
\_\_\_\_\_

The Common seal of the Brihanmumbai Municipal Corporation was hereunto affixed on the ..... 20 in the presence of two members of the Standing Committee.

1.

1.

2.

2.

And in the presence of the Municipal Secretary

Municipal Secretary

## ANNEXURE "A"

Name of work: - (HE-C-CT-CCRD-06) Laying/Replacement of various dia. water mains due to proposed improvement of roads in cement concrete in C ward & D ward of city section (2024-2026).

a) Name of Zone	City Zone I
b) Estimated cost of Tender	Rs. 33,55,41,977/- (Excluding GST)
c) Earnest Money (1% of the Estimated Cost of the tender)	Rs. 33,55,500/-
1. Definition	: The Engineer for this work is Hydraulic Engineer (HE)
2. Security Deposit Amended	
a) Contract Deposit	: 2% of the Contract Sum
b) Retention Money	: 5% of the Interim payment.
3. Contract Period	: 24 (Twenty-Four Months) (Excluding Monsoon.)
1) Contract as a whole	
4. Defect Liability Period	: Mentioned as under
1. For laying of CI/DI/MS/MDPE WM upto and including 300mm dia. and allied works as specified	1 year
2. For work of laying of water main of size more than 300mm diameter and allied works as specified	3 years
4. Renewal of service connections	1 year
8. DLP of Trenching Reinstatement work of various activities (as per RI tender floated by Road Department for reinstatement of trenches taken by various external and internal utilities in Greater Mumbai Z-1 to Z-VII)	
B) Carriageway:	
1. For Asphalt Work	3 Years
2. Paver Blocks	3 Years
3. Mastic Works	3 Years
4. UTWT/TWT Works	3 Years
5. CC Passage/CC Side strip	3 Years

6. CC Road	3 Years
<b>Footpath:</b>	
1 — Improvement of footpath in gray or any specified color or with short blasted paver block.	3 years
2 — In plain cement concrete (M 40) In stamp / stencil concrete (M 40) In CC with marble chip finish (M 40)	5 years
<b>5. Supervision Charges</b>	: Ten percent (10%)
<b>6. Advances (Recovery of advances)</b>	: as per G.C.C. in force

Signature of Issuing Officer  
Date:

Signature of Contractor

**Financial Bid Form**

I/We hereby confirm that I/ We have examined Tender Document including addendum etc. (as applicable), conditions of contract, specification, drawings, Bill of Quantities etc. forming part of the Tender and accordingly I/we hereby submit my/our offer to execute as per the tender documents in all respects at the quoted below.

1. Name of the Work \_\_\_\_\_ : **As on Cover page**  
 2. Name of Client \_\_\_\_\_ : **M. C. G. M.**  
 3. Name of Department \_\_\_\_\_ : **Hydraulic Engineer**  
 4. Estimated Cost \_\_\_\_\_ : **Rs.**

**(To be filled in by Tenderer)**

5a) Premium (in Figures) \_\_\_\_\_ % above the rates in B.O.Q/ Estimated cost.

\_\_\_\_\_ (in Words) \_\_\_\_\_ % above the rates in B.O.Q / Estimated cost.

Rs \_\_\_\_\_ In Words

Rs \_\_\_\_\_

**OR**

Rebate(in Figures) \_\_\_\_\_ % above the rates in B.O.Q /Estimated cost.(in Words) \_\_\_\_\_ % above the rates in B.O.Q /Estimated cost.Rs \_\_\_\_\_

In Word Rs \_\_\_\_\_

6. Total Cost of the Work — Rs \_\_\_\_\_

In WordsRs \_\_\_\_\_

7. Name and Title of Signatory \_\_\_\_\_ :

8. Name and address of tenderer \_\_\_\_\_ :

9. E-mail address of the firm \_\_\_\_\_ :

Telephone Nos. \_\_\_\_\_ :

**Signature of the Tenderer of the Firm**

<b>Full Names and Residential address and Tel. nos. of all partners constituting the firms:</b>	1.
	2.
	3.
	4.

(A separate sheet shall be attached for Names and addresses if necessary)

**Annexure- B****PRE-CONTRACT INTEGRITY PACT**

The Bidder commits himself to take all measures necessary to prevent corrupt practices, unfair means and illegal activities during any stage of his bid or during any pre-contract or post-contract stage in order to secure the contract or in furtherance to secure it and in particular commits himself to the following:-

1. The Bidder will not offer, directly or through intermediaries, any bribe, gift, consideration, reward, favour, any material or immaterial benefit or other advantage, commission, fees, brokerage or inducement to any official of the BMC, connected directly or indirectly with the bidding process, or to any person, organization or third party related to the contract in exchange for any advantage in the bidding, evaluation, contracting and implementation of the Contract.
2. The Bidder further undertakes that he has not given, offered or promised to give, directly or indirectly any bribe, gift, consideration, reward, favour, any material or immaterial benefit or other advantage, commission, fees, brokerage or inducement to any official of the BMC or otherwise in procuring the Contract or forbearing to do or having done any act in relation to the obtaining or execution of the Contract or any other Contract with the Government for showing or forbearing to show favour or disfavour to any person in relation to the Contract or any other Contract with the Government.
3. The Bidder will not collude with other parties interested in the contract to impair the transparency, fairness and progress of the bidding process, bid evaluation, contracting and implementation of the contract.
4. The Bidder will not accept any advantage in exchange for any corrupt practice, unfair means and illegal activities.
5. The Bidder, either while presenting the bid or during pre-contract negotiations or before signing the contract, shall disclose any payments he has made, is committed to or intends to make to officials of the BMC or their family members, agents, brokers or any other intermediaries in connection with the contract and the details of services agreed upon for such payments.
6. The Bidder shall not use improperly, for purposes of competition or personal gain, or pass on to others, any information provided by the BMC as part of the business relationship, regarding plans, technical proposals and business details, including information contained in any electronic data carrier. The Bidder also undertakes to exercise due and adequate care lest any such information is divulged.

7. The Bidder commits to refrain from giving any complaint directly or through any other manner without supporting it with full and verifiable facts.
8. The Bidder shall not instigate or cause to instigate any third person to commit any of the actions mentioned above.
9. The Bidder and their respective officers, employees, agents and advisers shall observe the highest standard of ethics during the Bidding Process. Notwithstanding anything to the contrary contained herein, the Authority may reject an Application without being liable in any manner whatsoever to the Applicant if it determines that the Applicant has, directly or indirectly or through an agent, engaged in corrupt practice, fraudulent practice, coercive practice, undesirable practice or restrictive practice in the Bidding Process

For the purposes of this Clause 9, the following terms shall have the meaning herein after respectively assigned to them:

1. “fraudulent practice” means a misrepresentation or omission of facts or suppression of facts or disclosure of incomplete facts, in order to influence the Bidding Process ;
1. “coercive practice” means impairing or harming or threatening to impair or harm, directly or indirectly, any person or property to influence any persons participation or action in the Bidding Process;
2. “undesirable practice” means (i) establishing contact with any person connected with or employed or engaged by the Authority with the objective of canvassing, lobbying or in any manner influencing or attempting to influence the Bidding Process; or (ii) having a Conflict of Interest; and
3. “Restrictive practice” means forming a cartel or arriving at any understanding or arrangement among Applicants with the objective of restricting or manipulating a full and fair competition in the Bidding Process.

Signature of Tenderer/Bidder



**Annexure- C**

(On Rs. 500/- Stamp Paper)

**DECLARATION CUM INDEMNITY BOND**

I, \_\_\_\_\_ of \_\_\_\_\_, do hereby declared and undertake as under.

1. I declare that I have submitted certificates as required to Executive Engineer(Monitoring) at the time of registration of my firm/company \_\_\_\_\_ and there is no change in the contents of the certificates that are submitted at the time of registration.

2. I declare that I \_\_\_\_\_ in capacity as Manager/Director/Partners/Proprietors of \_\_\_\_\_ has not been charged with any prohibitory and /or penal action such as banning(for specific time or permanent)/de-registration or any other action under the law by any Government and/or Semi Government and/or Government undertaking.

3. I declare that I have perused and examined the tender document including addendum, condition of contract, specifications, drawings, bill of quantity etc. forming part of tender and accordingly, I submit my offer to execute the work as per tender documents at the rates quoted by me in capacity as \_\_\_\_\_ of \_\_\_\_\_.

4.I further declare that if I am allotted the work and I failed to carry out the allotted work in accordance with the terms and conditions and within the time prescribed and specified, BMC is entitled to carry out the work allotted to me by any other means at my risk and cost, at any stage of the contract.

5. I also declare that I will not claim any charge/damages/compensation for non availability of site for the contract work at any time.

6. I declare that I will positively make the arrangements of the required equipment on the day of commencement or with respect to the progress of the work in phases, as per the instructions of site in charge

Signature of Tenderer/Bidder

**BANKERS GURANTEE IN LIEU OF CONTRACT DEPOSIT**

THIS INDENTURE made this \_\_\_\_\_ day of \_\_\_\_\_ BETWEEN

THE \_\_\_\_\_ BANK incorporated under the English/Indian Companies Acts and carrying on business in Mumbai (hereinafter referred to as 'the bank' which expression shall be deemed to include its successors and assigns)of the first part \_\_\_\_\_  
 \_\_\_\_\_ inhabitants carrying on business at \_\_\_\_\_  
 \_\_\_\_\_ in Mumbai under the style and name of Messer's \_\_\_\_\_  
 \_\_\_\_\_(hereinafter referred to as 'the consultant') of the second part Shri.  
 \_\_\_\_\_

THE MUNICIPAL COMMISSIONER FOR GREATER MUMBAI (hereinafter referred to as 'the commissioner' which expression shall be deemed, also to include his successor or successors for the time being in the said office of Municipal Commissioner ) of the third part and THE BRIHANMUMBAI MUNICIPAL CORPORATION(hereinafter referred to as 'the Corporation') of the fourth part WHEREAS the consultants have submitted to the Commissioner tender for the execution of the work of " \_\_\_\_\_ and the terms of such tender /contract require that the consultants shall deposit with the Commissioner as/contract deposit/ earnest money and /or the security a sum of Rs. \_\_\_\_\_(Rupees \_\_\_\_\_)AND WHEREAS if and when any such tender is accepted by the Commissioner, the contract to be entered into in furtherance thereof by the consultants will provide that such deposit shall remain with and be appropriated by the Commissioner towards the Security -deposit to be taken under the contract and be redeemable by the consultants, if they shall duly and faithfully carry out the terms and provisions of such contract and shall duly satisfy all claims properly chargeable against them there under AND WHEREAS the consultants are constituents of the Bank and in order to facilitate the keeping of the accounts of the consultants, the Bank with the consent and concurrence of the consultants has requested the Commissioner to accept the undertaking of the Bank hereinafter contained, in place of the contractors depositing with the Commissioner the said sum as earnest money and /or security as aforesaid AND WHEREAS accordingly the Commissioner has agreed to accept such undertaking NOW THIS AGREEMENT WITNESSES that in consideration of the premises, the Bank at the request of the consultants ( hereby testified ) UNDERTAKES WITH the commissioner to pay to the commissioner upon demand in writing , whenever required by him , from time to time , so to do ,a sum not exceeding in the whole Rs. \_\_\_\_\_(Rupees \_\_\_\_\_)under the terms of the said tender and /or the contract .The B.G. Is valid upto \_\_\_\_\_”Notwithstanding anything what has been stated above, our liability under the above guarantee is restricted to Rs. \_\_\_\_\_ only and guarantee shall remain in force upto \_\_\_\_\_ unless the demand or claim under this guarantee is made on us in writing on or

before \_\_\_\_\_ all your right under the above guarantee shall be forfeited and we shall be released from all liabilities under the guarantee thereafter”

IN WITNESS WHEREOF

WITNESS(1) \_\_\_\_\_

Name and \_\_\_\_\_

address \_\_\_\_\_

WITNESS(2) \_\_\_\_\_

Name and \_\_\_\_\_ the duly constituted Attorney Manager

address \_\_\_\_\_

the Bank and the said Messer’s \_\_\_\_\_

\_\_\_\_\_ (Name of the Bank)

WITNESS(1) \_\_\_\_\_

Name and \_\_\_\_\_

address \_\_\_\_\_

WITNESS(2) \_\_\_\_\_

Name and \_\_\_\_\_

For Messer’s \_\_\_\_\_

address \_\_\_\_\_

have here into set their respective hands the day and year first above written.

**The amount shall be inserted by the Guarantor, representing the Contract Deposit in Indian Rupees.**

**Annexure- D**  
**Rate Analysis**

Item Description

Sr.No.	Description of rate analysis parameters	Unit	Quantity	Rate	Amount
1	Basic Material (Rate should be inclusive of all taxes)				
2	Machinery Hire Charges				
3	Labour Type		(labour components)		
4	Total of all components				
5	Overhead & Profit 15% on 4				
6	Total Rate (4+5)				
7	Per unit rate				

Sign &amp; Seal of the Tenderer

## Annexure- E

Each tenderer shall upload scanned copy of an undertaking on stamp paper of Rs. 500/- as per proforma given below, in packet "B". The undertaking shall be submitted in physical format within seven days from the date of issue of work order, if the tender is awarded to the bidder.

"I/We .....(full name in capital letters, starting with surname) , the Proprietor / Managing Partner / Managing Director / Holder of the Business/Manufacturer/Authorized Dealer, for the establishment /firm/registered company, named herein below, do hereby state and declare that I/We....."

whose names are given herein below in details with the addresses have not filled in this tender under any other name or under the establishment / firm or otherwise, nor are we in any way related or concerned with any establishment, firm or any other person, who have filled in the tender for the aforesaid work".

I/We hereby further undertake that we have offered the **best prices** for the subject supply / work as per the present market rates. Further, we do hereby undertake and commit that we have not offered / supplied the subject product / similar product / systems in the past one year in Maharashtra state for quantity variation up to -50% / + 10% at a price lower than that offered in the present bid to any other outside agencies including Govt./semi Govt. agencies and within B.M.C also. Further, we have filled in the accompanying tender with full knowledge of the above liabilities and therefore we will not raise any objection or dispute in any manner relating to any action, including forfeiture of deposit and blacklisting, for giving any information which is found to be incorrect and against the instructions and directions given in this behalf in this tender.

I/We further agree and undertake that in the event it is revealed subsequently after the allotment of work / contract to me / us, that any information given by me / us in this tender is false or incorrect, I / We shall compensate the Brihanmumbai Municipal Corporation for any such losses or inconvenience caused to the Corporation in any manner and will not raise any claim for such compensation on any ground whatsoever. I / We agree and undertake that I / We shall not claim in such case any amount, by way of damages or compensation for cancellation of the contract given to me / us or any work assigned to me / us or as withdrawn by the Corporation."



**Annexure –G****➤ PROFORMA FOR THE UNDERTAKING TO BE SUBMITTED BY THE TENDERER  
(ON THEIR LETTERHEAD)**

Date: \_\_\_\_\_

To,  
The Municipal Commissioner,  
Brihanmumbai Municipal Corporation (BMC),  
Mumbai.

Sub: \_\_\_\_\_

Sir,

We, the undersigned hereby undertake that

1. All Asphalt Works required to be done under the captioned contract work shall be got executed with the specified asphalt mixes manufactured in B.M.C. Approved Asphalt Plants only.
2. All the Paver blocks required for the Paver block works to be carried out under the captioned contract work shall be procured from the specified manufacturers approved with B.M.C.
3. The R.M.C. works required to be done under the captioned contract work shall be got executed with the specified R.M.C. mixes supplied by B.M.C. Approved R.M.C. plants only.
4. All the pipes/ specials required for the works will be procured from the manufacturer approved with B.M.C only.
5. All the M.S pipes/ specials will be fabricated from B.I.S. approved Company/ I.S.O 9000 Certified Company, confirmed to I.S 3589, I.S 2062.
6. All the Air valves, Sluice valves & the Butterfly Valves will be procured from the Company approved with B.M.C.
7. All the observations & instructions made by the quality assurance agency appointed if any for the tender work are binding on us and same will be complied immediately.

Yours Faithfully,

Signature

Rubber Stamp.

**Annexure –H**

Information regarding status of tender (s)  
(To be submitted on Tenderers letter head)

- 1 a) whether it is proprietary concern?

\_\_\_\_\_

- b) If so, name of the owner

\_\_\_\_\_

If it is partnership concern, please furnish name and address of each partner and copy of registration certificate.

2. In case of Company, please furnish documentary proof to show that the Company registered.

Signature of authorized person of

Concern/ Company.



**Annexure –I**

**Irrevocable Undertaking**

(Notarized on Rs. 500/- Stamp Paper)

I Shri/ Smt.....aged,.....years Indian Inhabitant. Proprietor/  
Partner/ Director of M/s .....resident at .....do  
hereby give Irrevocable Undertaking as under;

- 1) I Say & undertake that as specified in section 171 of CGST Act, 2017, any reduction in rate of tax on supply of goods or services or the benefit of input tax credit shall be mandatorily passed on to BMC by way of commensurate reduction in prices.
- 2) I further say and undertake that I understand that in case the same is not passed on and is discovered at any later stage, BMC shall be at liberty to initiate legal action against me for its recovery including, but not limited to, an appeal to the Screening Committee of the GST Counsel.
- 3) I say that above said irrevocable undertaking is binding upon me/ my partners/ company/ other directors of the company and also upon my/ our legal heirs, assignee, Executor, administrator etc.
- 4) If fail to compliance with the provisions of the GST Act, I shall be liable for penalty/ punishment or both as per the provisions of GST Act.

Whatever has been stated here in above is true & correct to my/our own knowledge & belief.

Solemnly affirmed at

DEPONANT

THIS DAY OF

BEFORE ME

**PROFORMAS:****A) PROFORMA- I**

The list of similar works as stated in para 'A' of Post qualification during last seven years–

PROFORMA- I						
Sr.No.	Name of the Project	Name of the employer	Stipulated date of completion	Actual date of completion	Actual Cost of work done (in Lakhs)	Certifying Authority
1	2	3	4	5	6	7

**NOTE:**

- Scanned Attested copies of completion/performance certificates from the Engineer-in-Charge for each work should be annexed in the support of information furnished in the above proforma.
- Works shall be grouped financial year-wise.

**B) PROFORMA- II**

Audited annual turnover of Civil Engineering Construction Works during the last 5 years.

PROFORMA- II					
Sr.No.	Financial year	Annual Turnover of Civil Engineering Works	Updated value to current year	Average of last 3 years	Page No.
1					
2					
3					
4					
5					
Total					

**NOTE:** The above figures shall tally with the audited balance sheets uploaded by the tenderers duly certified by Chartered Accountant.

C) **PROFORMA- III**

At least similar work, as stated in para 'A' of Post qualification,

PROFORMA- III							
Name of the Project	Name of the Employer	Cost of the Project	Date of issue of work Order	Stipulated Date of Completion	Actual Date of Completion	Actual cost of work done	Remarks explaining reasons for delay, if any
1	2	3	4	5	6	7	8

**Note:** Scanned Attested copies of completion/performance certificates from the Engineer-in-charge for each work should be annexed in support of information furnished in the above proforma.

D) **PROFORMA- IV****PERSONNEL:**

PROFORMA- IV					
Sr. No.	Post	Name (Prime Candidate/ Alternate)	Qualification	Work Experience	
				No. of Years	Name of Projects
1	Project Manager				
2	Quality Control Engineer				
3	Site Engineer				
4	Site Supervisor				

**NOTE:** Scanned Attested copies of qualification certificates and details of work experience shall be submitted /uploaded.

E) **PROFORMA- V****MACHINERY:**b) **for special work**

PROFORMA V/A			
Sr.No.	Equipment	Number	Owned/Leased/Assured access
1	2	3	4

PROFORMA V/B			
Sr.No.	Equipment	Number	Owned
1	2	3	4

**Note:** The tenderer(s) shall furnish/upload the requisite Scanned Attested documents of ownership/leased of machineries. The undertaking from the suppliers will not be accepted.

c) **For Routine work/New & Original Works**

The tenderer(s) to qualify this bid shall either own equipments, in full working order, as listed below, or must demonstrate that based on known commitments, they will be available for timely use in the proposed contract as specified in Equipment Capability

<b>PROFORMA V/C</b>			
<i>Sr.No</i>	<i>Equipments owned / access to</i>	<i>Requirements (No)</i>	<i>RTO Vehicle nos / Invoice no.</i>
<i>1</i>	<i>2</i>	<i>3</i>	<i>4</i>
01	Pumps for dewatering		
02	Submersible pumps for dewatering		
03	Rock breaker with compressor		
04	Crane		
05	Pipe cutter		
06	Ratchet Drilling machine.		
07	Roller Vibratory Min. 10T		
08	Welding set.		
09	Compressor		
10	Transit Mixer (Tilted)		
11	J.C.B.		
12	Excavator / Poclain		
13	Dumper / Trucks 8 Cu.m capacity		
14	Dumper / Trucks 4 Cu.m capacity		
15	C.C.T.V. Camera		
16	Mobile D.G.set		
17	Plate Vibrator		

**Note:** ~~The tenderer(s) shall furnish/upload the requisite Scanned Attested documents of ownership/leased of machineries. The undertaking from the suppliers will not be accepted.~~

**F) PROFORMA - VI**

Details of Existing Commitments and ongoing works –

<b>PROFORMA - VI / A</b>							
Description of work	Place	Contract No. & Date	Name & Addresses of employer	Value of Contract in Rs.	Scheduled date of completion	Value of work remaining to be completed	Anticipated Date of completion
1	2	3	4	5	6	7	8

**Note:** Scanned Attested copies of completion/performance certificates from the Engineer-in-Charge for each work should be annexed in the support of information furnished in the above proforma.

Details of works for which bids are already uploaded –

<b>PROFORMA - VI / B</b>						
Description of work	Place	Name & Addresses of employee	Value of Contract in Rs.	Time Period	Date on which decision is expected	Remarks
1	2	3	4	5	6	7

**Note:** Scanned Attested copies of certificates from the Engineer-in-charge for each work shall be annexed.

**PROFORMA VII-DELETED**

~~Maximum Quantity of total Pavement Quality Concrete (M35 or richer mix) on volumetric basis in Cu.m, completed in one single contract during the last seven(7) financial/calendar years~~

<i>Year</i>	<i>Name of the Works</i>	<i>Name of the Employers</i>	<i>Quantity of Concrete (M35 or richer mix) (Cum)</i>	<i>Remarks</i>
<i>1</i>	<i>2</i>	<i>3</i>	<i>4</i>	<i>5</i>

**G) PROFORMA VIII**

~~The tenderer to qualify this bid shall own or have assured access (through hire, lease, and other commercial means) in full working order, to the equipment's as listed below, and must demonstrate that based on known commitments, they will be available for timely use in the proposed contract.~~

<i>Sr.No</i>	<i>Equipment</i>	<i>No</i>
<i>1</i>	<i>2</i>	<i>3</i>
1	Computerized Batch mix Asphalt Plant Capacity min. 80 M.T per hr. with valid registration of B.M.C.	
2	R.M.C Plant (computerized) – Capacity 60 Cu.m per hr. (or two nos. of 30 Cu.m. per hr. in lieu of 60 cum per hr.) with valid registration of B.M.C.	
3	Paver Blocks (BIS Certified) manufacturing factory approved by B.M.C with valid registration.	

**NOTE:** a) The minimum suggested major equipment's to begin with for execution of works in accordance with the prescribed construction schedule are shown in the above list. The contractor shall mobilize prior to bidding of this bid and mandatorily during the contract implementation, additional equipment as directed by Engineer-in-charge.

**H) PROFORMA IX**

Information on Litigation History in which the tenderer is involved.

<i>Other Party (ies)</i>	<i>Employer</i>	<i>Cause of Dispute</i>	<i>Amount involved</i>	<i>Remarks showing Present Status.</i>
<i>1</i>	<i>2</i>	<i>3</i>	<i>4</i>	<i>5</i>

**Note:** Scanned Attested copies of completion/performance certificates from the Engineer-in-charge for each work should be annexed and uploaded.

**I) PROFORMA – X**

Information of certificate issuing authorities

<i>Sr.No.</i>	<i>Employer/Name of issuing Authority</i>	<i>Designation of issuing Authority</i>	<i>E-mail ID of issuing Authority</i>	<i>Contact numbers of issuing Authority</i>
---------------	---	---	---------------------------------------	---

~~J) PROFORMA XI: DELETED.~~

**~~INFORMATION ABOUT INSTALLATION OF SCADA ETC.~~**

~~MANDATORY REQUIREMENT FOR REGISTERED/ASSURED PLANTS REQUIRED AND TO ALL MACHINERIES OWNED/ASSURED REQUIRED.~~

**MANDATORY REQUIREMENT:**

<i>Particulars</i>	<i>Whether Installed</i>	<i>Copies of Certification of installer company enclosed.</i>
	<i>Yes/No</i>	<i>Yes/No</i>
<i>1</i>	<i>2</i>	<i>3</i>
Intelligent Compaction system—compatible for L&T, Escort, JCB, Greaves or equivalent make Compactors.		
Agent Software for Compactor		
Batch Mix Plant SCADA Automation		
Software Agent Batch Mix Plant connectivity		
Software agent RMC plant connectivity		
Vehicles Tracking System with automation loading unloading Switch		
Vehicles Tracking System—Per month Subscription charges		
SCADA Automation for ICPB Factory		

**Note:— Intending tenderer shall give undertaking to provide the information on SCADA as required in PROFORMA X.**

**MUNICIPAL CORPORATION OF GREATER MUMBAI**

No. : MGC/F/6565 dtd. 25-9-2018

**CIRCULAR**

Sub : Setting up the parameters of litigation history of the bidders.

As approved by Hon'ble M.C., the clause of litigation history be included as part of SBD as below :-

- 1) The bidder shall disclose the litigation history in Packet 'B' under the head "Details of Litigation History".

If there is no Litigation History, the bidder shall specifically mention that there is no Litigation History against him as per the clause of Litigation History. In case there is Litigation History -

**Litigation History must cover – Any action of blacklisting, debarring, banning, suspension, deregistration and cheating with MCGM, State Govt., Central Govt. or any authority under State or Central Govt./Govt. organisation initiated against the company, firm, directors, partners or authorized signatory shall be disclosed for last 5 years from the date of submission of bid. Also, bidder must disclose the litigation history for last 5 years from the date of submission of bid about any action like show cause issued, blacklisting, debarring, banning, suspension, deregistration and cheating with MCGM and MCGM is party in the litigation against the company, firm, directors, partners or authorized signatory for carrying out any work for MCGM by any authority of MCGM and the orders passed by the competent authority or by any Court where MCGM is a party. While taking decision on litigation history, the concerned Chief Engineer or D.M.C. or Director, as may be the case, should consider the details submitted by bidder and take decision based on the gravity of the litigation and the adverse effect of the act of company, firm, directors, partners or authorized signatory on the MCGM works which can spoil the quality, output, delivery of any goods or any work execution and within the timeframe.**

- 2) The litigation history shall be treated as curable defect and hence, the portion/clause of SBD, (C) Bid Capacity at Pg. 15 & in the chapter of 'Instructions to Applicants' at Pg. 31 of the SBD will be now corrected by deleting the word litigation history and shall be read as below.

**C) Bid Capacity :**

The bid capacity of the prospective bidders will be calculated as under: Assessed Available Bid Capacity =  $(A * N * 2 - B)$

Where,

A = Maximum value of Civil Engineering works executed in any one year (year means Financial year) during the last five years (updated to the price level of the Financial year in which bids are received at a rate of 10% per year) taking into account the completed as well as works in progress.

N = Number of years prescribed for completion of the Project/Works, excluding monsoon period, for which these bids are being invited. (E.g. 7 months = 7/12 year). For every intervening monsoon, 0.33 shall be added to N.

B = Value of existing commitments (only allotted works) on the last date of submission of bids as per bidding document and on-going works to be completed during the period of completion of the Project/Works for which these bids are being invited.

Note: The statement showing the value of existing commitments and on-going works as well as the stipulated period of completion remaining for each of the works listed should be attached along with certificates duly signed by the Engineer-in Charge, not below the rank of an Executive Engineer or equivalent.

Even though the bidders meet the above qualifying criteria, they are subject to be disqualified if they have:

- made misleading or false representation in the forms, statements and attachments submitted in proof of the qualification requirements; and/or
- Record for poor performance such as abandoning the works, not properly completing the contract, inordinate delays in completion, litigation-history, or financial failures etc."

All the concerned are directed to implement the above directions with immediate effect.

o/c

Director (E. S. & P.)

*Good 27/9/18*

City Engineer/Ch.Eng.(Roads & Traffic) / Ch.Eng. (Bridges) / H. E. / Ch.Eng. (WSP) /Ch.Eng.(S.P.) /Ch.Eng.(S.O.)/ Ch.Eng.(MSDP) / Ch.Eng. (BM) / Ch.Eng.(Vig) / Ch.Eng. (MSE) / Ch.Eng.(D.P.)/Ch.Eng.(SWD) / Ch.Eng. (Coastal Road) / Ch.Eng.(SWM) / Ch.Eng.(CTIRC)/Dy. Ch.Eng.(HIC) / Dy.Ch.Eng.(SIC) / Supt. of Gardens/

Asstt. Comm. Ward / Asstt. Comm.(Markets) / Asstt. Comm. (Estate) / Asstt. Comm.(Planning) / Asstt. Comm.(R.E.) City/W.S./E.S.

No. DIRES & P/915/MC dtd. 27-9-2018

C.C. to : DMC(MCO)/ DMC (Imp.) / DMC(GA)/ DMC(Vig)/ DMC(SE) / DMC(E)/ DMC(CPD)/ DMC(SWM)/DMC (Education)/DMC (RE)/ DMC(PH)/ DMC(Z-I) / DMC(Z-II) / DMC(Z-III) / DMC(Z-IV) / DMC(Z-V) / DMC(Z-VI) / DMC(Z-VII) / C.A. (F) / C.A. (WSSD) / C.A. (C.P.D.) / Law Officer

Forwarded for information please.

o/c

Director (E.S. & P.)

*Good 27/9/18*

No. No. DIR/ES & P/915/MC dtd. 27-9-2018

C.C. to:

Submitted please.

o/c

Director (E.S. & P.)

*Good 27/9/18*

A.M.C.(City) / A.M.C.(E.S.) / A.M.C.(W.S) / A.M.C(P)

Sir/Madam, —



# Municipal Corporation of Greater Mumbai

No. Dy.Ch.Eng./SWM/3957/Qp. dt. /09/2018

## CIRCULAR

28-9-2018

**Subject:** Implementation of the Construction and Demolition Waste Management Rules, 2016

**Reference:** i) Hon'ble Supreme Court's order in the Special Leave Petition (civil) No. D 23708/2017, dated 15/03/2018  
ii) Hon'ble M.C. Sir's Approval u/no. MGC/F/7076 dtd. 30.08.2018

The Construction and Demolition Waste Management Rules, 2016 is applicable to 'every waste resulting from construction, re-modeling, repair and demolition of any civil structure of individual or organisation or authority who generates construction and demolition waste such as building materials, debris, rubble'.

Hon'ble Supreme Court vide order dated 15/03/2018, has directed to dispose of construction and demolition waste material by following due procedure in accordance with the provisions of the Construction and Demolition Waste Management Rules, 2016".

In order to put curb on the un-authorisedly dumped waste, it is essential to control it by asking ward Maintenance department or any MCGM department to issue work-permission only after assessing the total estimated quantity of C&D waste likely to be generated out of the repairs / construction / trenching work or any such civil works, and asking them to make payment in advance or in stages of waste generation for the 'Debris on Call' system or transport C&D waste to designated unloading site.

Following standard operating procedure is proposed to be adopted:

- 1) MCGM department like A. E. (Maintenance), A. E. (B&F), H.E., S.O., S.P., M.S.D.P., W.S.P., S.W.D., S.W.M., C.E., B.C., B.M., Roads, Bridges, etc. carrying out civil work / repairs works etc. shall put condition in the tender / quotation / work order to dispose of C&D waste generated either by (i) 'Debris on Call' scheme if generation of C&D waste is less than 300MT for entire project or (ii) contractor shall transport to designated unloading site approved by MCGM S.W.M. department by following due procedure if C&D waste is more than 300MT for entire project.
- 2) The estimated quantity of the C&D waste generated shall be certified by A.E. (Maintenance) Ward or the concerned department.
- 3) If quantity of C&D waste is less than 300MT, A. E. (S.W.M.) Ward will issue Challan for making payment as per 'Debris on call' scheme on approval from Zonal Ex. Eng. (S.W.M.).
- 4) If quantity of C&D waste is more than 300MT, the contractor / agency will submit C&D waste management plan complete with requisite documents to Zonal Ex. Eng. (S.W.M.). On approval, the contractor / citizen / agency carrying out the civil works will be allowed to transport the C&D waste material to the designated unloading site.
- 5) The contractor / citizen / agency carrying out the civil works shall maintain & submit the appropriate record like date, quantity of C&D waste transported, vehicle No., Challan of Receipt of C&D waste from unloading site etc.
- 6) The whole system of issuing NOC for C&D waste transportation and payment will be made ONLINE and for this M/S. Softtech will be asked to develop appropriate software on the basis of existing norms being done for auto-DCR portal.
- 7) The proposals will be processed manually till the complete system fully operational online.
- 8) All the contractors / agencies using designated unloading site must maintain proper record of the C&D waste generated and transported along with date and vehicles through which C&D is transported & the copies of Challans from unloading site for having unloaded the C&D waste and submit the same to A.E. (S.W.M.) ward through concerned department.

Sd/-07/08/2018  
Ch. Eng. (S.W.M.)

Sd/-07/08/2018  
D.M.C. (S.W.M.)

Sd/-10/08/2018  
A.M.C.(E.S.)

Sd/-29/08/2018  
Municipal Commissioner

Forwarded for information and compliance please

*[Signature]*  
23/9/18  
Dy. Ch. Eng. (SWM) Op.

D:\Online C&D Dept\Unauthorised C&D waste.docx

Scanned by CamScanner

**MUNICIPAL CORPORATION OF GREATER MUMBAI**

No. 1 MGC/W/8659 Dtd. 07.09.2019.

Sub : Arbitration clause in the Standard General Conditions of Contract for Construction Works, 2016.

In one of the cases of W.S.P. regarding arbitration dispute, a note was submitted by Dy Law Officer (High Court, Suit & Pl.) and subsequently the report is submitted by Jt. M.C. (Vig.) vide No. Jt.M.C./Vig./69/MC dtd. 21-8-2019 proposing a process to deal with the arbitration matters as per the Law & Judiciary, Govt. of Maharashtra, policy for institutional arbitration vide it's G.R. dtd. 13-10-2016 and the report submitted by Jt. M.C. (Vig.) is approved by Hon'ble M.C. on 17-8-2019.

There is a provision of arbitration clause in the Standard General Condition of Contract for Construction Works, point no. 13 (e) reads as follows :-

**13.(e) Arbitration and Jurisdiction:**

If the Commissioner shall fail to give notice of the decision as aforesaid within a period of 90 days after being requested as aforesaid, or if the Contractor be dissatisfied with any such decision, then and in any such case the Contractor may within 90 days after receiving notice of such decision or within 90 days after the expirations of the first named period of 90 days (as the case may be) require that the matter or matters in dispute be referred to arbitration as hereinafter provided. All disputes or differences in respect of which the decision (if any) of the Commissioner has not become final and binding as aforesaid shall be finally settled by arbitration as follows:

Arbitration shall be effected by a single arbitrator agreed upon the parties. The arbitration shall be conducted in accordance with the provisions of the Arbitration Act, 1996 or any statutory modifications thereof, and shall be held at such place and time within the limits of Brihan Mumbai as the arbitrator may determine. The decision of the arbitrator shall be final and binding upon the parties hereto and the expense of the arbitration shall be paid as may be determined by the arbitrator. Performance under the Contract shall, if reasonably be possible, continued during the arbitration proceedings and payment due to the Contractor by the Employer shall not be withheld unless they are the subject matter of arbitration proceedings. The said arbitrator shall have full power to open up, review and revise any decision, opinion, direction, certification or valuation of the Commissioner and neither party shall be limited in the proceedings before such arbitrator to the evidence or arguments put before the Commissioner for the purpose of obtaining his said decision.

No decision given by the Commissioner in accordance with the foregoing provisions shall disqualify him from being called as a witness and giving evidence before the arbitrator on any matters whatsoever relevant to the disputes or difference referred to the arbitrator as aforesaid.

All awards shall be in writing and for claims equivalent to 5,00,000 or more such awards shall state reasons for amounts awarded. The expenditure of arbitration shall be paid as may be determined by arbitrator.

In case of any claim, dispute or difference arising in respect of a contract, the cause of action thereof shall be deemed to have arisen in Mumbai and all legal proceedings in respect of any claim, dispute or difference shall be instituted in a competent court in the City of Mumbai only.

As per Hon'ble M.C.'s approval dtd. 17-8-2019, the existing clause is now replaced as follows :

### 13.e Arbitration and Jurisdiction

If the Commissioner fails to give notice of the decision as aforesaid within a period of 90 days after being requested as aforesaid or if the Contractor is dissatisfied with any such decision, then the Contractor may within 90 days after receiving notice of such decision or within 90 days after the expiration of the first named period of 90 days (as the case may be) require that the matter or matters in dispute be referred to arbitration as hereinafter provided.

i) In case of a contract where the contract price and/ or contract value is less than Rs. 5,00,00,000/- (Rupees Five Crore Only), any dispute arising out of or in connection with this contract, including any question regarding its existence, validity or termination, shall be referred to a mutually agreed arbitral tribunal in accordance with the Arbitration and Conciliation Act, 1996 (amended upto date). The arbitral tribunal shall consist of a sole arbitrator, as mutually agreed upon by the parties and the said dispute shall be finally resolved by the said arbitral tribunal. The decision of the arbitral tribunal shall be in writing (with reasons) and which will be final and binding upon the parties hereto and the expenses of the arbitration shall be paid as may be determined by the arbitral tribunal. The seat of the arbitration shall be Mumbai. The venue of arbitration shall be within the limits of Brihan Mumbai. The language of the Arbitration shall be English.

If the parties fails to appoint mutually agreed arbitral tribunal, within the period of 30 days from the date of application seeking arbitration in the dispute,

the arbitral tribunal shall be appointed by the recognised arbitral institution i.e. Mumbai Centre for International Arbitration (approved by Government of Maharashtra under G.R. no. ARB/Case No. 1/2017/D-19 dtd. 28.02.2017) as per the Arbitration Rules of the Mumbai Centre for International Arbitration then in force ("MCIA Rules").

(ii) In case of contract where the contract price and/ or contract value is Rs.5,00,00,000/- (Rupees Five Crore Only) or more, any dispute arising out of or in connection with such a contract, including any question regarding its existence, validity or termination, shall be directly referred to and finally resolved by the recognized arbitral institution i.e. Mumbai Centre for International Arbitration (approved by Government of Maharashtra under G.R. no. ARB/Case No. 1/2017/D-19 dtd. 28.02.2017) as per the Arbitration Rules of the Mumbai Centre for International Arbitration then in force ("MCIA Rules"). The arbitral tribunal shall consist of a sole arbitrator. The seat of the arbitration shall be Mumbai. The language of the Arbitration shall be English.

In either case, the law governing this arbitration agreement and the contract shall be Indian Law.

All the HoDs are hereby directed to note the revised clause in G.C.C. as mentioned above and ensure that the same is included in the tenders invited from 15-1-2019 onwards. If the tenders are already invited before 15-1-2019 and the Packet 'A' is not opened, then the corrigendum shall be issued so as to see that all the new tenders accepted/invited after 15-9-2019 shall include this revised condition and will become a part of the contract for all such works.

Sd/-22.08.2019  
Dir. (E.S. & P.)

Sd/-29.08.2019  
A.M.C. (P)

Sd/-06.09.2019  
M.C.

No. : DIR/ES&P/919/MC dtd. 16.09.2019.

Copy to :

Asstt. Comm. A-107 Ward / City Engineer/Ch.Eng.(Roads & Traffic) / Ch.Eng. (Bridges) / H. E. / Ch.Eng. (WSP) / Ch.Eng. (S.P.) / Ch.Eng. (MSDP) / Ch.Eng. (BM) / Ch.Eng. (Vlg) / Ch.Eng. (M&E) / Ch.Eng. (D.P.) / Ch.Eng. (SWD) / Ch.Eng. (SWM) / Ch.Eng. (CTIRC) / Ch.Eng. (Coastal Roads) / Dy. Ch.Eng. (HIC) / Dy. Ch.Eng. (SIC) / Suptt. of Gardens / CA (F) / CA (WSSD) / CA (CPD)

Forwarded for information and necessary action please.

*[Signature]*  
Director (E.S. & P.)

No.. : DIR/ES&P/919/MC dtd,16.09.2019.

C.C. to : DMC(MCO)/ Jt.MC(GA)/ DMC(SE) / DMC(E)/ DMC(CPD)/  
Jt.MC(SWM)/ DMC(Z-I) / DMC(Z-II) / DMC(Z-III) / Jt.MC(Z-IV) / Jt.MC(Z-V)/  
DMC(Z-VI)/ Jt.MC(Z-VII) / D.M.C. (PII) / DMC (Edu.) / DMC (RE) / DMC (DM)

Forwarded for information please.

o/c

Director (E.S.& P.)

No.. : DIR/ES&P/919/MC dtd,16.09.2019.

C.C. to: Law Officer

For compliance of para 'Y' at Pg. N/35 at your end and do the needful as per Hon'ble M.C.'s order. Original file is forwarded herewith.

o/c

Director (E.S.& P.)

No.. : DIR/ES&P/919/MC dtd,16.09.2019.

C.C. to:

As per the note of Law Officer u/no. LO/LOP/3110/ Dy.LO (H.C. suits & PIL) dt.28.08.2019, the clause as modified by Law Officer & which is approved by Hon'ble M.C. is included in the circular please while issuing the circular.

Submitted please.

Director (E.S.& P.)

Jt.MC(Vig)/A.M.C.(City) / A.M.C.(E.S.) / A.M.C(W.S) / A.M.C(P)

Sir/Madam,

Hon'ble M.C.

o/c

Sir,

महाराष्ट्र शासन

क्रमांक : बीसीसी २०१९/प्र.क्र.५७८ अ/१६-व  
सामान्य प्रशासन विभाग, मंत्रालय,  
हुतात्मा राजगुरु चौक, मादाम कामा मार्ग,  
मुंबई - ४०००३२.  
दिनांक : १ जानेवारी, २०२०.

प्रति,

MC/City/.....<sup>२</sup>/<sub>१८/२/२०२०</sub>

आयुक्त,  
बृहन्मुंबई महानगर पालिका,  
मुंबई.

विषय : सांविधानिक अनुसूचित जाती/ जमाती व इतर मागासवर्गीयांसाठी  
नोकरीमध्ये असलेल्या आरक्षण घोरणाची अंमलबजावणी करणेबाबत.

~~उपरोक्त (S.A.)~~

उ.प्र.प.०.

महोदय,

उपरोक्त विषयाबाबतची श्री.सुधीर बंडू जाधव, समाजसेवक यांच्या दि.२.१२.२०१९  
च्या निवेदनाची प्रत सोबत जोडली आहे. N.R.

A.M.C. (City)

२. श्री.जाधव यांनी उपरोक्त निवेदनाद्वारे बृहन्मुंबई महानगरपालिकेमार्फत निविदेद्वारे  
करण्यात येणाऱ्या ४५ दिवसांपेक्षा अधिक कालावधीच्या कामासाठी आरक्षण  
अधिनियमानुसार मागासवर्गीय उमेदवारांना आरक्षण देण्याबाबतची विनंती केलेली आहे.

प्र.क्र.३.

पुढील कार्यवाहीसाठी

३. महाराष्ट्र राज्य लोकसेवा (अनुसूचित जाती, अनुसूचित जमाती, निरविसूचित  
जमाती (विमुक्त जाती), भटक्या जमाती, विशेष मागास प्रवर्ग आणि इतर मागासवर्ग  
यांच्यासाठी आरक्षण) अधिनियम, २००१ च्या कलम ३ नुसार ४५ दिवसांपेक्षा अधिक  
कालावधीसाठीच्या तात्पुरत्या नियुक्त्यांसाठी, सदर आरक्षण लागू केलेले असल्याने  
त्यानुसार उचित कार्यवाही करण्याचे संबंधितांना निदेश द्यावेत, ही विनंती.

सह आयुक्त  
(सामान्य प्रशासन)

बृहन्मुंबई महानगरपालिका आयुक्तांचे कार्यालय	
15 FEB 2020	
समय	११, १२, १३, १४, १५, १६, १७, १८,
क्रमांक	MC/ 6803

आपला,

(र. अं. खडसे)

अवर सचिव, महाराष्ट्र शासन

बृहन्मुंबई महानगरपालिका

सामान्य प्रशासन विभाग

क्र. २ मबीसी/६९९३ दि. २०.०३.२०२० ५/५/२०२०

परिपत्रक

विषय: संवैधानिक अनुसूचित जाती व जमाती व इतर मागासवर्गीय  
यांच्यासाठी नोकरीमध्ये असलेल्या आरक्षण धोरणाची  
अंमलबजावणी करणे बाबत.

संदर्भ: क्र.बीसीसी २०१९/प्र.क्र.५७८/ए/१६-ब दि.०१.०१.२०२०

सोबत जोडलेले, अवर सचिव, महाराष्ट्र शासन यांचे पत्र क्र.बीसीसी २०१९/प्र.क्र.५७८/ए/१६-ब दि.०१.०१.२०२० सर्व खाते प्रमुख/विभाग प्रमुख यांच्या माहितीकरिता व योग्य त्या कार्यवाहीकरिता निर्गमित करण्यात येत आहे.

सदर पत्रातील निर्देशानुसार बृहन्मुंबई महानगरपालिकेमार्फत निविदेद्वारे करण्यात येणाऱ्या ४५ दिवसांपेक्षा अधिक कालावधीसाठीच्या कामांसाठी महाराष्ट्र राज्य लोकसेवा (अनुसूचित जाती, अनुसूचित जमाती, विमुक्त जाती, भटक्या जमाती, विशेष मागास प्रवर्ग आणि इतर मागास वर्ग यांच्यासाठी आरक्षण) अधिनियम २००९ च्या कलम ३ नुसार ४५ दिवसांपेक्षा अधिक कालावधीसाठीच्या तात्पुरत्या नियुक्त्यांसाठी, सदर आरक्षण लागू केलेले आहे. त्यानुसार ४५ दिवसांपेक्षा अधिक कालावधीसाठीच्या तात्पुरत्या नियुक्त्यांसाठी आरक्षणाचे नियम लागू करण्याची कार्यवाही खातेस्तरावरून करण्यात यावी.

सर्व खाते/विभाग प्रमुखांना सूचित करण्यात येते की, शासनाच्या क्र.बीसीसी २०१९/प्र.क्र.५७८/ए/१६-ब दि.०१.०१.२०२० रोजी दिलेल्या शासनाचे निर्देशांची अंमलबजावणी काटेकोरपणे करण्यात यावी.

सही/- दि. १९.०३.२०२० सह प्रमुख कर्मचारी अधि. (मागासवर्ग कक्ष)	सही/- दि. १९.०३.२०२० प्रमुख कर्मचारी अधिकारी	सही/- दि. १३.०३.२०२० सह आयुक्त (सामान्य प्रशासन)	सही/- दि. १९.०३.२०२० अति. आयुक्त (शहर)
--	---	---	---

बृहन्मुंबई महानगरपालिका  
जिल्ह अतिरिक्त कार्यवाही  
उप-जिल्हा अभियंता (सह-कार्यालय)

प्रक्र.अ/ ७५ /सर्वसा/एमसी/३०४

२०१९-२०२०

मनपा आयुक्तांचे कार्यालय

क्र.एमबीसी/६९९३

दि. १३.०४.२०२०

06 JUL 2020

684

आय आर

प्रत नगर आयुक्त कार्यावाहीकरिता उपर्या अग्रपेठित. सदर परिपत्रकाची प्रत यांना माहितीकरिता व महानगरपालिकेच्या  
योजनेच्या कार्यवाहीकरिता उपर्या अग्रपेठित. सदर परिपत्रकाची प्रत यांना माहितीकरिता व महानगरपालिकेच्या  
<http://45.249.109.226/circular/GAD/GPO/BCCell> या संकेतस्थळावर उपलब्ध आहे.  
सोबत: क्र.बीसीसी २०१९/प्र.क्र.५७८/ए/१६-ब दि.०१.०१.२०२०

AOCO

SPK

सह प्रमुख कर्मचारी अधिकारी (मा.व.क.)

शा.व.क. ५/५/२०२०

3-42243 (1-2)

**MUNICIPAL CORPORATION OF GREATER MUMBAI**

**CIRCULAR**  
**2019-20**

No. CA(F)/EXP/F1/21 dated 30.09.2019

Sub: A Running / final bill of project work shall be accompanied with GIS mapping certificate.

With the aim of avoiding duplication of works in the same geography within MCGM, it has been decided to integrate SAP Project Systems (PS) module with Geographical Information System (GIS) to map all the civil works on GIS and link payment with the actual progress on map.

The whole objective has been divided into two phases. In first phase of development, integration of GIS with SAP PS module for 6 departments (Roads & Traffic, Bridges, Sewerage Operations, Storm Water Drains, Hydraulic Engineering and Sewerage Projects) for mapping of all Civil works in GIS. In this, WBS elements of various works of these six departments will be released and in turn Purchase (Work) Order in project system module will be created only after the works are mapped on GIS. Phase I application has been made live w. e. f. 17.08.2019.

In second phase, from 01.10.2019 onwards, the progress of the work needs to be linked with the GIS mapping system for all departments. Payment to the contractor will be released as per work completed & reflected on GIS mapping. According to that progressive running bills / final bill of project works shall be accompanied with GIS mapping certificate. This geospatial data will help for solving the problems and making process decisions as per visualized data in a spatial environment. Further, from 01.10.2019 onwards, if any running bills / final bills are not accompanied with GIS mapping certificate, the same will not be accepted for payment. In case of non-payment of bills to the contractor as per tender conditions, the respective engineer in-charge will be held responsible.

The guidelines given by this circular should be followed scrupulously.

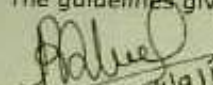
  
CA (Finance) 04/9/19.

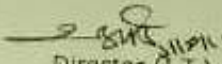
  
Director (I.T.)

Jt.M.C.(Vigilance)

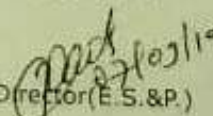
  
Director (E.S.&P.)

A.M.C.(E.S.)

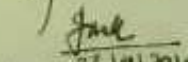
  
25/9/2019  
A.M.C.(Project)

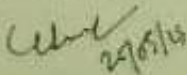
  
27/09/19

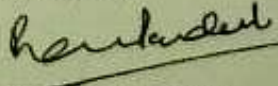
  
Municipal Commissioner



**MUNICIPAL CORPORATION OF GREATER MUMBAI**

**CIRCULAR**

**No.CA (F)/Project/31 Dt. 26/10/2020.**

**Subject:** - Revised Policy for Governing Extra-excess-saving

**Ref:-** 1. Circular No.CA/FRD/I/57 dt.13.03.2013.

2. Circular No. Dir/E.S.&P./324 dt.15.07.2015.

At present the extra/excess/saving proposals are dealt as per Decision Rules framed under circular No.CA/FRD/I/57 of 13.03.2013 &Dir/E.S.&P./324 dt.15.07.2015.

Hon'ble M.C. has directed to review the existing Decision Rules and amend it suitably. Accordingly, in view to exercising effective control over the extra/excess and speedy process of such proposal during execution of the work, the powers of approval of extra/excess /saving and Fair items are reviewed and delegated according to the attached modified statement-"A". Except this, other conditions of Circular No. DIR./E.S.&P./324 dt.15.07.2015 shall remain unchanged and will be applicable as it is.

The "Decision Rules" framed and circulated apropos circular No.CA/FRD/I/57 of 13.03.2013 and Dir/ES&P/324 of 15.07.2015 shall remain applicable for those extra/excess works which were executed before issuance of these amended rules/directives by obtaining prior administrative approval of competent authority, as the case may be.

The revised policy for governing Extra/Excess and Fair items will come into effect immediately from the issuance of this circular.

All Chief Engineers/ Head of Departments/Deans shall note the above directives and follow them scrupulously.

Sd/- 13.10.2020

**C. A. (WSSD)**

Sd/- 13.10.2020

**C. A. (Finance)i.c.**

Sd/- 13.10.2020

**D.M.C. (Infra)**

Sd/- 13.10.2020

**D.M.C.(E.)**

Sd/- 14.10.2020

**D.M.C.(S.E.)**

Sd/- 13.10.2020

**Dir.(E.S.&P.)**

Sd/- 16.10.2020

**A.M.C. (Project)**

Sd/- 23.10.2020

**Municipal Commissioner**

**Statement –A**

**(i) Extra/Excess/Saving**

Nature of work	Permissible limit of Extra/Excess/Saving and Approving authority		
	DMC(Infra)/ DMC(E)/ DMC(SE)/ Dir(ES&P)/ Jt.M.C.	Concerned A.M.C.	Municipal Commissioner
General Work/ Underground works/ Unforeseen works	<p>(i) <u>Cumulative</u> amount of Extra/Excess/Saving in any <u>individual item</u> Upto Rs.25 Lakh And</p> <p>(ii) Total <u>Cumulative</u> amount of Extra/Excess/Saving <u>on all items</u> upto 5% of the total contract cost, but not exceeding Rs.1 crore</p>	<p>(i) <u>Cumulative</u> amount of Extra/Excess/Saving in any <u>individual item</u> Upto Rs.1crore And</p> <p>(ii)Total <u>Cumulative</u> amount of Extra/Excess/Saving <u>on all items</u> upto 15 % of the total contract cost, but not exceeding Rs.10 crore</p>	<p>(i) <u>Cumulative</u> amount of Extra/Excess/Saving in any <u>individual item</u> above Rs.1Crore And / OR</p> <p>(ii)Total <u>Cumulative</u> amount of Extra/Excess/Saving <u>on all items</u> above 15% of the total contract cost. And / OR</p> <p><u>Cumulative</u> amount of Extra/Excess/Saving <u>on all items</u> exceeding Rs.10 Crores.</p>
<p><b><u>Payment Terms:</u></b>  <u>Excess Items</u> shall be paid as per the rates quoted by the tenderer at the time of tender  <u>Extra Items</u> shall be paid as per the rate prevailing in “Unified Schedule of Rate” of MCGM at the time of tender at rebate quoted by the contractor or at Par in case of premium quoted by the contractor at the time of tender</p>			

(ii) Fair Item

Nature of work	Permissible limit of Fair Item and Approving authority		
	DMC(Infra)/DMC(E)/DMC(SE)/Dir(ES&P)/Jt.M.C.	Concerned A.M.C.	Municipal Commissioner
For all nature of work	Total <u>Cumulative</u> amount of Fair <u>on all items</u> upto 2% of the total contract cost, but not exceeds Rs.20 Lakh	Total <u>Cumulative</u> amount of Fair <u>on all items</u> upto 5 % of the total contract cost, but not exceeds Rs.1 crore (Other than the proposals in the purview of DMC/Jt.MC)	Total <u>Cumulative</u> amount of Fair <u>on all items</u> above 5% of the total contract cost. And / OR <u>Cumulative</u> amount of Fair <u>on all items</u> exceeding Rs.1 Crore.

Payment Terms:

Fair Items shall be got approved by the concerned DMC/Dir(ES&P)/Jt.M.C. The engineer in-charge shall work out these fair items at fair and reasonable market rates on the basis of material, labour and operation of construction equipment required to execute the item and allowing 15% to cover profits and overhead charges(i.e. including taxes, duties, etc.) On the same lines of rate analysis prepared for the items that are in "Unified Schedule of Rate" of MCGM.

The rates of Fair Items shall be valid for one year only. Moreover, no escalation will be admissible on the fair items till the completion of such works, in which the fair items are executed.

Fair Items shall be paid at PAR in case of premium quoted by the contractor, in newly created FAIR ITEM or item not included in prevailing "Unified Schedule of Rate" of MCGM at the time of tender. OR at rebate quoted by the contractor if it is already added in prevailing "Unified Schedule of Rate" of MCGM at the time of tender.

Sd/- 13.10.2020 Sd/- 13.10.2020 Sd/- 13.10.2020 Sd/- 13.10.2020 Sd/- 13.10.2020 Sd/- 13.10.2020  
C. A. (WSSD) C. A. (Finance)i.c. D.M.C.(Infra) D.M.C.(E.) D.M.C.(S.E.) Dir.(E.S.&P.)

**MUNICIPAL CORPORATION OF GREATER MUMBAI**

**Chief Engineer (Vigilance) Department**

ChE/Vig/ 1938 / B dtd. 23/11/21

**CIRCULAR**

**Subject:-** The guidelines related to re-assessment of strength of concrete for MCGM project works in cases of -

- i) Non satisfactory results of concrete cube 28 Days Compressive Strength.
- ii) Non satisfactory results of Concrete Core Compressive Strength test.

The Hon'ble M.C. vide approval u/no. MCP/2447 dated 15-11-2021 has approved the guidelines related to reconfirmation / re-assessment of strength of concrete in case of non-satisfactory results for 28 days compressive strength of concrete cubes / cores.

The guidelines are as under -

- (i) In order to achieve the confirmation about satisfactory strength of concrete as per the relevant I.S. code provisions, it is necessary that specific clause in the tender '**Directions to the contractor**' need to be incorporated regarding the methodology for testing of samples -  
  
In case of non- satisfactory/ failed results of 28 days concrete compressive strength, if 28 days concrete cube compressive strength test samples at MTL/ private NABL accredited labs are not satisfactory / failed; in such circumstances, the re-assessment of strength of concrete shall invariably to be done only at Municipal Testing Laboratory (MTL) by joint witness by the officer not below the rank of Assistant Engineer of the project and the representative of the contractor for assurance & acceptance of the strength of concrete work.
- (ii) The existing practise/procedure followed in the on-going contracts for various engineering works / projects of MCGM to allow re-confirmation/ re-assessment of concrete strength at Municipal

approved private NABL accredited labs shall be discontinued with immediate effect.

- (iii) In case of failure of test results in the on-going works, the further testing for reassurance of the strength as per the relevant tender condition shall only be done at Municipal Testing Lab (MTL) in presence of staff of user department not below the rank of Assistant Engineer and in presence of representative of the contractor.
- (iv) In case of failure of re-confirmation of test report as envisaged in para (iii) above, the action as per the provisions of 8(f) of SGCC shall be strictly initiated by the executing department by obtaining the prior approval of concerned HOD.

All H.O.D.'s/ Asst. Commissioner's of ward are hereby informed & directed to instruct all the concerned Engineering staff to take the note of the above guidelines and implement with immediate effect, in proposed tenders / quotations / on-going works.

The copy of the above circular is being mailed on the official email address of the respective H.O.D./ Asst. Commissioner.

All Dy HES

Please peruse, note and ensure compliance of Ch.E.(Vig)'s guidelines with immediate effect, by instructing all concerned EEs/AEs/SB-technical staff, under you.

*[Signature]*  
HE

*[Signature]*  
23/11/2021  
Sudhir V. Gajargaonkar  
Ch.E. (Vigilance)

COPY

Copy to:  
For information and necessary action

City Engineer	Ch.E.(Rds. & Tr.)	Ch.E.(S.W.D.)	Ch.E.(Bridges)
Ch.E.(B.M.)	Hydraulic Engineer	Ch.E.(S.P.)	Ch.E.(S.O.)
Ch.E.(S.W.M.) Projects	Ch.E.(S.W.M.)	Ch.E. (Coastal Road)	Ch.E.(GMLR)
Ch.E.(W.S.P.)	Ch.E.(M.S.D.P.)	Ch.E.(CTI&RC)	
A.C. A Ward	A.C. B Ward	A.C. C Ward	A.C. D Ward
A.C. E Ward	A.C. F/S Ward	A.C. F/N Ward	A.C. G/S Ward
A.C. G/N Ward	A.C. H/E Ward	A.C. H/W Ward	A.C. K/E Ward
A.C. K/W Ward	A.C. P/S Ward	A.C. P/N Ward	A.C. R/S Ward
A.C. R/N Ward	A.C. R/C Ward	A.C. L Ward	A.C. M/E Ward
A.C. M/W Ward	A.C. N Ward	A.C. S Ward	A.C. T Ward

MUNICIPAL CORPORATION OF GREATER MUMBAI  
HYDRAULIC ENGINEER'S DEPARTMENT  
No. Dy.H.E.(C)/5730 / IR dtd. 25/3/2022

**Subject:** Providing & fixing of valves (Butterfly valves, Air Valves, Sluice Valves etc.) for the works in Construction Division on the basis of MCGM specification i.e. without insisting for procurement through approved manufacturer.

**Ref.:** i) क्र.ज.अ./ 2256 / एस.आर. 08.12.2021.  
ii) Minutes of meeting of Valve Committee (VAC) held on 01.09.2021.

A detailed note was submitted for the perusal of H.E. and seeking approval to allow to use (P/F) of different types of valves in Construction Division on the basis of MCGM specification & not to insist the procurement through approved manufacturer, as was done by Dy.H.E.(Maint.).

Thereafter, in the Valve Committee Meeting held on 01.09.2021, it was decided that specific and proven make valves are very much necessary at source i.e. primary network. The secondary network as well as tertiary network is successfully operated & maintained with the valves of MCGM specification. It was further decided to overview the performance of the valves procured with MCGM specifications (without Make) in distributory mains by 31.03.2021 (procured by all sections of H.E.).

Now, the Hydraulic Engineer has accorded approval and allowed the procurement / fixing of valves in distributing mains on the basis of MCGM specification, without adhering to the list of approved manufacturer, as being done by Dy.H.E.(Maint.). However for any tapping at primary network / tunnel, the valves with proven make shall only be used / fixed.

All concerned are herewith directed to take a note of the above approval.

-sd-  
Dy.H.E.(Const.)

E.E.W.W.(Const.) City

E.E.W.W.(Const.) E.S.

E.E.W.W.(Const.) W.S.

A.O.(Const.)

c.c. to : Dy.H.E.(Maint.)

-sd-  
Dy.H.E.(Const.)

c.c. to : Hydraulic Engineer  
Sir,

Copy submitted for information please.

-sd-  
Dy.H.E.(Const.)

## बृहन्मुंबई महानगरपालिका परिपत्रक

प्र.ले./वित्त/प्रकल्प/२८ दि. २८/०३/२०२३

विषय: एकसामायिक दरसूची २०२३ अंतर्भूत करुन महानगरपालिकेद्वारे हाती घेण्यात येणारी विविध कामे तसेच प्राप्त करण्यात येणा-या वस्तु व सेवा इत्यादीबाबतच्या ई-निविदा/निविदा/दरपत्रक यामध्ये वस्तु व सेवा कराच्या अनुषंगाने अंतर्भूत करावयाच्या अटीबाबत.

संदर्भ: १) प्र.ले./वित्त/प्रकल्प/२५ दि.१२.०७.२०२२

२) संचालक/अ.से.व प्र./२९१/एमसी दि.३१.०१.२०२३

बृहन्मुंबई महानगरपालिकेद्वारे हाती घेण्यात येणारी विविध कामे तसेच प्राप्त करण्यात येणा-या वस्तु व सेवा इत्यादीबाबतच्या ई-निविदा/निविदा/दरपत्रक यामध्ये वस्तु व सेवा कराच्या अनुषंगाने अंतर्भूत करावयाच्या अटीबाबत संदर्भित क्र. १ वरील परिपत्रकान्वये सूचना प्रसृत केल्या आहेत.

महानगरपालिका आयुक्त यांच्या क्र. एमजीसी/एफ/८७७१ दि. ३०.०१.२०२३ अन्वये एकसमान दरसूची २०२३ प्रसारीत करण्यात आली आहे. सदर एकसामायिक दरसूची २०२३ हि वस्तु व सेवाकर वगळून तयार करण्यात आली आहे. सदर अद्ययावत एकसामायिक दरसूची २०२३ नुसार अंदाजपत्रक तयार करुन मागविण्यात आलेल्या/येणा-या ई-निविदा/निविदा/दरपत्रक यांमध्ये वस्तु व सेवाकराच्या अनुषंगाने महानगरपालिकेद्वारे हाती घेण्यात येणारी विविध कामे तसेच प्राप्त करण्यात येणा-या वस्तु

व सेवा इत्यादीबाबतच्या ई-निविदा/निविदा/दरपत्रक यामध्ये संदर्भित क्र.१ अन्वये दिलेल्या अटीमध्ये पुढीलप्रमाणे बदल करण्यात येत आहे.

विद्यमान अट	सुधारित अट
<p>“GST and other state levies/cess which are not subsumed under GST will be applicable. The tenderer shall quote inclusive of all taxes <u>applicable at the time of bid submission</u>. It is clearly understood that BMC will not bear any additional liability towards payment of any Taxes &amp; Duties.</p> <p>Wherever the services to be provided by the Tenderers, falls under Reverse Charge Mechanism, the Price quoted shall be exclusive of GST, but inclusive of Taxes/Duties/Cess other than GST, if any.</p> <p>Rates accepted by BMC shall hold good till completion of work and no additional individual claim shall be admissible on account of fluctuations in market rates; increase in taxes/any other levies / tolls etc. except that payment/recovery for overall market situation shall be made as per Price variation <b>and if there is any subsequent change (after submission of bid) in rate of GST applicable on the work/services to be executed as per tender, i.e. any increase will be reimbursed by BMC whereas any reduction in the rate of GST shall be passed on to BMC as per the provisions of the GST Act.</b></p>	<p>The tenderer shall quote inclusive of all taxes other than GST (<b>Excluding GST</b>), <u>Levies, Duties, Cess etc as applicable at the time of bid submission</u>. GST as applicable shall be paid separately on submission of bills/invoice.</p> <p>Input Tax Credit of GST as available with the bidder will not be claim separately by BMC. However, while quoting the rates benefit of Input Tax Credit or Exemptions shall be passed on to the BMC by way of equivalent reduction in quoted price.</p>



उपरोक्त सुधारीत अट अद्ययावत एकसामायिक दरसूची २०२३ नुसार अंदाजपत्रक तयार करुन मागविण्यात आलेल्या/ येणा-या ई-निविदा/निविदा/दरपत्रक या कामांकरिता लागू असेल.

अतएव, सध्या ज्या ई-निविदा/निविदा/दरपत्रक एकसामायिक दरसूची २०२३ अंतर्भूत करुन मागविलेल्या आहेत अशा निविदांमध्ये नियत दिनांकापूर्वी शुद्धीपत्रकाद्वारे उपरोक्त सुधारीत अट समाविष्ट करण्याबाबत तसेच यापुढे एकसामायिक दरसूची २०२३ अंतर्भूत करुन मागविण्यात येणा-या ई-निविदा/निविदा/दरपत्रक यांमध्ये उपरोक्त सुधारीत अट समाविष्ट करण्याबाबत संबंधित खातेप्रमुख यांनी दक्षता घ्यावी.

सर्व खातेप्रमुख, रूग्णालयांचे अधिष्ठाता, सहायक आयुक्त, यांनी उपरोक्त सुचनांचे काटेकोरपणे अनुपालन करावे.

सही/- २८/०३/२०२३

(पांडुरंग गोसावी)

**प्रमुख लेखापाल (पा.पु.म.नि.)**

सही/- २८/०३/२०२३

(प्रदिप पडवळ)

**प्रमुख लेखापाल (वित्त) प्र.**

सही/- २८/०३/२०२३

(रामदास आव्हाड)

**उप आयुक्त (वित्त)**

सही/- २८/०३/२०२३

(पी. वेलरासू)

**अतिरिक्त आयुक्त (प्रकल्प)**

**BRIHANMUMBAI MUNICIPAL CORPORATION****Chief Engineer (Vigilance) Deptt.****Circular****No.ch.E(V)/436/B dated 18/05/2023**

Sub: - Annexing the Clause of GRC (Grievance Redressal committee) in the tenders.

Ref: - 1) AMC(P)'s approval U.no. AMC/P/677 dated 27.04.2023

As per the directions of AMC(P) u.no. AMC/P/677 dated 27.04.2023, all the concerned HODs, Ch.Eng. are requested to annex the Clause of GRC (Grievance Redressal committee) accompanying with this circular, in every tenders, so that vendor directly do not approach to higher authorities.

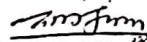
  
(Girish B. Nikam)  
**Chief Engineer (Vigilance)**

C.C. to:

City Engineer, Hydraulic Engineer, Ch. E.(Roads & Traffic), Ch.E.(S.W.D.), Ch.E.(C.S.),  
Ch. E. D.P., Ch.E.(W.S.P.), Ch.E.(S.P.), Ch.E.(S.O.), Ch. E. (B.M.), Ch.E.(M&E),  
Ch.E.(M.S.D.P.), Ch.E.(S.W.M.), Ch.E.(C.T.I.&R.C.),  
C.A.(Finance), C.A.(Treasury), C.A.(Stores), Law Officer.  
Dy.Ch. E. (Roads)City /W.S./E.S., Dy.Ch. E.(Bridges), Dy.H.E. City/W.S./E.S.,  
Dy.Ch. E. (S.W.D.)City/E.S./W.S., Dy.Ch.E.(Civil)Environmental, Dy.Ch.(SIC),  
Dy.Ch.E.(B.M.)City/W.S./E.S., Dy.H.E.(Ops), Dy.H.E.(PPC), Dy.H.E.(Const),  
Dy.C.E.(P.I.Cell), Dy.Ch.E(HIC), Dy.C.E. (BC)City / E.S./ W.S., Dy.H.E.(Maint),  
Dy.Ch.E.(Traffic),  
Asst. Comm.(A.H.T.)Wards., Asst. Comm.(Market.), Asst. Comm.(Estate),  
E.E. (B.C.) City, E.E. (B.C.) W.S., E.E. (B.C.) E.S., E.E.(M & R), E.E. (Garden  
Cell)A.O.FAS, A.O.FSA, A.O.FRD-II (City), A.O. (Stores), A.O.(Transport),  
Dean KEM Hospital, Dean Nair Hospital Dean Sion Hospital, Dean Cooper Hospital.

## ANNEXURE

## GRIEVANCE REDRESSAL MECHANISM

BMC has formed a Grievance Redressal Mechanism for redressal of bidder's grievances. Any Bidder or prospective Bidder aggrieved by any decision, action or omission of the procuring entity being contrary to the provisions of the tender or any rules or guidelines issued therein, in Packet 'A', 'B' & 'C' can make an application for review of decision of responsiveness in Packet 'A', 'B' & 'C' within a period of 7 days or any such other period, as may be specified in the Bid document.

While making such an application to procuring entity for review, aggrieved bidders or prospective bidders shall clearly specify the ground or grounds in respect of which he feels aggrieved.

Provided that after declaration of a bidder as a successful in Packet 'A' (General Requirements), an application for review may be filed only by a bidder who has participated in procurement proceedings and after declaration of successful bidder in Packet 'B' (Technical Bid), an application for review may be filed only by successful bidders of Packet 'A'. Provided further that, an application for review of the financial bid can be submitted, by the bidder whose technical bid is found to be acceptable / responsive.

Upon receipt of such application for review, BMC may decide whether the bid process is required to be suspended pending disposal of such review. The BMC after examining the application and the documents available to him, give such reliefs, as may be considered appropriate and communicate its decision to the Applicant and if required to other bidders or prospective bidders, as the case may be.

BMC shall deal and dispose off such application as expeditiously as possible and in any case within 10 days from the date of receipt of such application or such other period as may be specified in pre-qualification document, bidder registration document or bid documents, as the case may be.

Where BMC fails to dispose off the application within the specified period or if the bidder or prospective bidder feels aggrieved by the decision of the procuring entity, such bidder or prospective bidder may file an application for redressal before the "Internal Procurement Redressal Committee" within 7 days of the expiry of the allowed time or of the date of receipt of the decision, as the case may be. Every such application for internal redressal before Redressal Committee shall be accompanied by fee of Rs.25,000/- and fee shall be paid in the form of D.D. in favour of M.C.G.M.

**1<sup>st</sup> Appeal by the bidder against the decision of C.E./ HOD/ Dean can be made to concerned DMC/Director who should decide appeal in 7 days.**

**If not satisfied, 2<sup>nd</sup> Appeal by the bidder can be made to concerned A.M.C. for decision.**

Grievance Redressal Committee (GRC) is headed by concerned D.M.C./ Director of particular department for the first appeal/ grievances by the bidder against the decision for responsiveness / non- responsiveness in Packet 'A', Packet 'B' or Packet 'C' and if not satisfied, concerned A.M.C. will take decision as per second appeal made by the bidder.

**This Grievance Redressal Committee (GRC) will be operated through DMC (CPD) office where appeals of aggrieved bidder will be received with fee of Rs. 25,000/- from aggrieved bidder. The necessary correspondence in respect of said applications to the aggrieved bidder & concerned department, issuing notices, arranging of Grievance Redressal Committee (GRC) with D.M.C. and further proceeding will be carried out through registrar appointed by MCGM.**

No application shall be maintainable before the redressal Committee in regard of any decision of the BMC relating to following issues:

Determination of need of procurement

The decision of whether or not to enter into negotiations.

Cancellation of a procurement process for certain reasons.

On receipt of recommendation of the Committee, It will be communicate his decision thereon to the Applicant within 10 days or such further time not exceeding 20 days, as may be considered necessary from the date of receipt of the recommendation and in case of non-acceptance of any recommendation, the reason of such non-acceptance shall also be mentioned in such communication.

Additional Municipal Commissioner and/or Grievance Redressal Committee, if found, come to the conclusion that any such complaint or review is of vexatious, frivolous or malicious nature and submitted with the intention of delaying or defeating any procurement or causing loss to the procuring entity or any other bidder, then such complainant shall be punished with fine, which may extend to Five Lac rupees or two percent of the value of the procurement, whichever is higher.

Full Signature of the tenderer with

Official Seal and Address

## Municipal Corporation of Greater Mumbai

Subject- Modification in GIS condition to be incorporated in upcoming HE department's tender.

Ref- EE/WDIP/SR/51/DT 15.06.2023

In Continuation to the above reference this is to inform that, there are some modifications in Sr no 1a & 1b of GIS condition and same should be read as under.

1) Contractor has to capture digital photographs and Geo coordinates (i.e. Latitude and Longitude) of each work (during execution of the work) In the following manner:

- a) Contractor shall use latest GPS equipment in DGPS mode (RTK/PPK) for capturing Latitude/Longitude coordinates of Water Network Assets, which are compatible to the MCGM's existing DGPS Setup to get desired data quality.
- b) The GPS coordinates shall be captured strictly in the presence of the concerned MCGM Site in charge. The photographs of the process of capturing the Geo coordinates with the help of latest DGPS Machine shall be taken and submitted as part of records to the concerned EEWW(Const).

Rest GIS Condition from Sr.No 1c to 10 will be the same as mentioned in the above reference (pg C-1 to C-5)

Submitted please,

E.E./WDIP/ SR / <sup>53</sup>...../DT.  
22 JUN 2023

DyHE(Const.)

Copy To-  
EEWW(Const.) ES  
EEWW(Const.)WS  
EEWW(Const.)City

Forwarded for information please.

sd  
EE(WDIP)

Shauhan  
22/06/23.  
EE(WDIP)

o/c c-1

## Municipal Corporation of Greater Mumbai

Subject- GIS condition to be incorporated in upcoming HE department's tender.

Reference is please requested to the minutes of meeting under no. HE/398/SR/OT Dated 16.05.2023. As per the direction given by HE in MoM at point no. 3, this department has modified GIS condition and same is as below:

- 1) *Contractor has to capture digital photographs and Geo coordinates (i.e. Latitude and Longitude) of each work (during execution of the work) In the following manner:*
- a) *Contractor shall use latest DGPS Rover of Trimble for capturing Latitude/Longitude coordinates of Water Network Assets, which are compatible to the MCGM's existing DGPS Setup i.e. GPS Receiver Trimble NetR9*
  - b) *The GPS coordinates shall be captured strictly in the presence of the concerned MCGM Site in charge. The photographs of the process of capturing the Geo coordinates with the help of Trimble Machine shall be taken and submitted as part of records to the concerned EEWW(Const).*
  - c) *The contractor shall capture the coordinates of water network assets and post process the DGPS Rover data in back office and generate "shape file" format using the 10 point character for attribute table as attached which is mandatory for uploading on One MCGM. Reference coordinates for shape file shall be WGS 1984 UTM 43N.*
  - d) *For water mains, contractor shall capture Geo coordinate in the following manner:*
    - i) *At start point, at every turning point and end point.*
    - ii) *Every bend shall be captured at both the ends to confirm the direction of water main.*
    - iii) *For straight alignment of water main, Geo coordinates shall be taken at every 50m interval.*
    - iv) *The coordinates of all Cross-connection points, Sluice valves, Valve chamber, BFVs, Air valves, Hydrants, Reducer, End cap, Manhole chamber, shall also be captured.*

- e) *In congested area where network is not available or poor, submission on Google Earth can be accepted for WDJP work only and not for laying work.*
- 2) *The contractor shall enter the field attribute data in the asset format attached and submit along with shape file for GIS Mapping Certificate.*
- 3) a) *Wherever necessary the contractor shall carry out TSS survey of Road where laying of water main work is to be executed. For TSS, use nearest MCGM's GCP monuments (total 24 monuments are available across Greater Mumbai) for reference.*
- b) *For TSS survey. The contractor shall use UTM 43N using local datum (THD values from the nearest pillar) as directed by MCGM . Three-point location data should be given with field attribute data as per Asset formats attached along with the shape file and submit to the department. All water related features i.e. Pipe lines, valve chamber, hydrant, air valve etc. shall be marked on TSS with reference to urban vicinity features such as land mark, bus top, electrical poles, sewer main holes etc.*
- 4) *Tenderer shall also submit a certified hard copy of the surveyed data on Google earth map. It is also mandatory to submit detailed schematic sketch signed by concerned construction staff for assets such as cross connection, water main, diversion, reducer and service connection.*
- 5) *The attribute data of the H.E.'s assets shall be filled up in the prescribed formats as attached by Concern Contractor's representative and the site in charge, which shall be endorsed by concerned Executive Engineer.*
- 6) *The completion drawings shall be prepared using HE's existing GIS data/ One MCGM portal available with Executive Engineer(Construction).*
- 7) *After completion of work, the geo spatial data in "shape file", along with attribute data in prescribed formats as attached, shall be submitted to*

EE(WDIP) for updating in H.E.'s GIS database within two month, failing which a penalty of Rs. 500 per day will be recovered from the contractor.

- 8) It is required to capture the geo spatial data on exposed main while carrying out the work for better accuracy in order to update HE's GIS data.
- 9) Tenderer shall note that, 5% amount of the total work done will be withheld for GIS work. The 5% deposit withheld will be released only after GIS Mapping Certificate is received from MWDIP department. This 5 %retention shall be in addition to the amount retained as retention money and amount withheld as per vigilance circular. Running bill/final bill shall be accompanied with GIS Mapping Certificate as per circular CA(F)/EXP/F1/22 Dated 30.09.2019.
- 10) The contractor shall note that no separate payment will be made for capturing GPS coordinates, carrying out TSS survey wherever required, and submission of photographs, CD of Auto CAD & shape files etc.

Enclosed:

- 1) Prescribed Asset formats (page no. 3 to 33)
- 2) Asset formats with 10 point character for attribute table of Shape File (page no 35 to 61)

Submitted please,

*Dhaudhari*  
9/c EE(WDIP) 05/06/23

E.E./WDIP/ SR /...51.../DT.  
15. JUN 2023

DyHE(Const.)



41  
27

C/1

FROM THE DESK OF  
MUNICIPAL COMMISSIONER

No. MC/C/A/1386

Dt: 13/03/2023

The following Committee is hereby constituted to formulate the strategy for implementation of Mumbai's Air Pollution Mitigation Plan as announced in the BMC Budget for the year 2023-24:-

1.	Shri. Sanjeev Kumar	AMC (WS)	Chairman
2.	Shri Atul Patil	Director (E.S.& P.)	Member Secretary
3.	Shri Ulhas Mahale	DMC (Infra)	
4.	Smt. Chanda Jadhav	DMC (SWM)	
5.	Shri Manish Patel	ChE (Roads)	
6.	Shri. Sunil Rathod	ChE (DP)	
7.	Shri Kartik Langote	Representative of MPCB	
8.	Shri. S.B. Gite	Ex.Engg.(MCO)	

**TORs. of Committee are as under:**

1. Find out reasons for high degree of air pollution in Mumbai.
2. Suggest measures to reduce / minimise air pollution due to infrastructure projects, such as Metro, Roads, SWD, Coastal Roads, STPs. etc.
3. Measures to minimise air pollution due to building construction projects.
4. Monitoring mechanism for overseeing the implementation of air pollution mitigation measures including penalising the delinquents.

The committee shall give its objective report in seven working days.

13/3-23  
Municipal Commissioner

Copy To: \_\_\_\_\_

**BRIHANMUMBAI MUNICIPAL CORPORATION**  
(Hydraulic Engineer's Department)  
**CIRCULAR**

HE/01/Cir dated 11/05/2022

Subject: - Certification of all types of ward proposals under HE Department.

Reference: - HE/2184/IC dated 19/04/2022.

As per HE's approval vide No. HE/2184/IC dated 19/04/2022 for certification of all types of proposals under HE Department proposed by AEWW of respective wards and approved by EEWW(P&R)/Dy HE(P&C). The guidelines for certification of works through ward proposals are as under-

1. Certification of all type of ward proposals (150 mm dia. W.M. to 600 mm dia. WM) shall be obtained from EEWW (P&R) before handing over to AEWW of ward.
2. Certification of all type of ward proposals (Above 600 mm dia. WM) shall be obtained from Dy. HE (P&C) through EEWW (P&R) before handing over to AEWW of ward.
3. Certification of all type of ward proposals (below 150mm dia. W.M.) shall be obtained from AEWW of respective wards.
4. AEWW (Construction) shall submit all the details with drawings with GIS entry certification or migration on one MCGM plan & get certification of overall work by EEWW (P&R) office before commissioning of proposed work in co-ordination with AEWW of respective wards.

Dy HE(Const) section shall get certified the work executed through approved ward proposals from the office of EEWW (P&R) with required details for its consideration in the future planning purpose and keep updating the data time to time. It is mandatory to certify the work before handing over to the wards. The certified work shall be sent to ward for handing over & further process.

*[Signature]*  
Dy HE (P&C) 11/5/22

Copy To : DyHE(Const)/DyHE(City)/DyHE(ES)/DyHE(WS)/EEWW(Const)City/ EEWW(Const)ES/

EEWW(Const)WS/EE(P) to HE/AO(HE)/AEWW( )Ward./EEWW(WDIP)

<p>बृहन्मुंबई महानगरपालिका कार्यकारी अभियंता जलकामे (बांधकाम) पश्चिम उपमहारे</p> <p>दिनांक ... 27/5/22 ... <i>[Signature]</i> ..... 10/11/22 .....</p>
--

*All AE/SE/IE*

स. नं. भि. च. क. (व्यं) प. उप. परि - 3.4.7 *[Signature]*

मुख्य लिपिक (देयके) / आस्था.

*pl note*

कृ. आचार्यक कार्यकारी कार्यालयी

*pl note*

30/5/22

कार्य. अभि. च. क. (व्यं) प. उप.

*SEWW RG*  
*PP. note*  
*[Signature]*

## बृहन्मुंबई महानगरपालिका विधी खाते

परिपत्रक क्र. २६२०६ दि. 31.08.2023

विषय - कंत्राट करार करण्यासाठी वसूल करावयाचे विधी आकार (Legal charges) व लेखनसाहित्य आकार (Stationery charges)

संदर्भ - 1. परिपत्रक क्र. 10539 दि. 28.03.2023  
2. एमजीसी/एफ/534 दि. 28.08.2023

.....

महानगरपालिकेच्या विविध खात्यांमार्फत मागविण्यात येणा-या निविदांसंदर्भात लेखी करार करताना पक्षकाराकडून एकत्रितरित्या आकारावयाच्या विधी आकार व लेखनसाहित्य आकाराची उपरोक्त संदर्भित क्र. 1 वरील परिपत्रकानुसार दि. 01.04.2023 पासून आकारणी करण्यात आलेली आहे.

तथापि महानगरपालिका आयुक्त यांच्या संदर्भ क्र. 2 च्या मंजूरीनुसार कंत्राट करार करण्यासाठी वसूल करावयाचे विधी आकार (Legal charges) व लेखनसाहित्य आकार (Stationery charges) यामध्ये सुधारणा करण्यात आली असून खालील तक्त्यामध्ये दर्शविल्याप्रमाणे दि.01.09.2023 पासून सुधारीत विधी व लेखनसाहित्य (एकत्रितरित्या) आकार विहित करण्यात आलेले आहेत.

अनु. क्र	कंत्राट किंमत	एकत्रितरित्या आकारावयाचे सुधारीत विधी व लेखन साहित्य आकार दि. 01.09.2023 पासून दि. 31.03.2024 पर्यंत
1	रु.. 50,000/-	निरंक
2	रु. 50,001 ते रु. 1,00,00,000	कंत्राट किंमतीच्या 0.10% दराने (अशी येणारी रक्कम पुढील शंभराच्या पटीत परावर्तित करणे यासापेक्ष) अधिक 18% दराने वस्तू व सेवाकर ( किमान रु. 1000/- अधिक वस्तू व सेवाकर आणि कमाल रु. 10000/- अधिक वस्तू व सेवाकर )
3	रु. 1,00,00,001 ते रु. 10,00,00,000/-	रु. 1,00,00,000/- पर्यंतच्या कंत्राट किंमतीसाठी रु.10,000/- अधिक रु. 1,00,00,000/- पेक्षा जास्त रक्कमेवर 0.05% दराने (अशी येणारी रक्कम पुढील शंभराच्या पटीत परावर्तित करणे यासापेक्ष) अधिक 18% दराने वस्तू व सेवाकर

4	रु. 10,00,00,001 ते पुढील कंत्राट किमतीसाठी	रु. 10,00,00,000/- पर्यंतच्या कंत्राट किमतीसाठी रु.55,000/- अधिक रु. 10,00,00,000/- पेक्षा जास्त रक्कमेवर 0.01% दराने (अशी येणारी रक्कम पुढील शंभराच्या पटीत परावर्तित करणे यासापेक्ष) अधिक 18% दराने वस्तू व सेवाकर
---	---	--

*Shobha*  
31/8/23  
( शोभा अजितकुमार )  
उप कायदा अधिकारी  
(हस्तांतरण -2)  
विधि खाते

*Sanjay*  
31-08-2023  
( संदिप मो. पाटील )  
संयुक्त कायदा अधिकारी (प्र.)  
(शहर दिवाणी न्यायालय)  
विधि खाते

*Sunil*  
31/8/2023  
( सुनिल सोनवणे )  
कायदा अधिकारी  
विधि खाते

परिपत्रक क्र. दि. 31.08.2023

प्रत ..... यांना माहीतीकरीता व पुढील  
आवश्यक त्या कार्यवाहीकरीता अग्रेषित.

*Sanjay*  
31-08-2023  
( संदिप मो. पाटील )  
उप कायदा अधिकारी (आस्थापना )  
विधि खाते

बृहन्मुंबई महानगरपालिका

परिपत्रक

२०२३-२०२४

क्र. सीए/एफआरजी/ १८ दिनांक २७.०२.२०२४

विषय:- महानगरपालिकेच्या विविध खात्यांमार्फत मागविण्यात येणा-या अनस्टार दरपत्रिका / निविदा / दरपत्रिका / ई-दरपत्रिका / ई-निविदा दस्तऐवजांच्या किंमतीच्या दरात वाढ करण्याबाबत

- संदर्भ :- १) परिपत्रक क्र.सीए/एफआरजी/०३ दि. ११.०५.२०२३  
 २) परिपत्रक क्र.सीए/एफआरजी/०४ दि.२४.०५.२०२३  
 ३) परिपत्रक क्र.सीए/एफआरजी/१० दि. १९.१०.२०२३

बृहन्मुंबई महानगरपालिकेच्या विविध खात्यांमार्फत मागविण्यात येणाऱ्या अनस्टार दरपत्रिका / निविदा / दरपत्रिका / ई-दरपत्रिका / ई-निविदा दस्तऐवज याबाबत आकारावयाचे छाननी शुल्क उपरोक्त संदर्भ क्र. ०१ वरील परिपत्रकानुसार दिनांक ११.०५.२०२३ पासून दिनांक ३१.०३.२०२४ पर्यंत आकारण्याबाबत निर्देश देण्यात आले होते. तसेच उपरोक्त संदर्भ क्र. १ च्या परिपत्रकात मा. अतिरिक्त आयुक्त (प्रकल्प) यांच्या मंजूरी अन्वये वेळेवेळी सुधारणा करून उपरोक्त संदर्भ क्र. २ व ३ ची परिपत्रके निर्गमित करण्यात आली आहेत.

दिनांक ११.०५.२०२३ पासून लागू करण्यात आलेल्या अनस्टार दरपत्रिका / निविदा / दरपत्रिका / ई-दरपत्रिका / ई-निविदा दस्तऐवजांकरिता आकारावयाच्या छाननी शुल्क दरांमध्ये परिपत्रक क्र. सीए/एफआरएम/७ दि. ०३.०५.२०२१ व परिपत्रक क्र. सीए/एफआरएम/४९ दि. ०७.०२.२०१३ अन्वये सन २०२४-२५ या वर्षामध्ये १०% वाढ करण्यात येत आहे. तसेच महानगरपालिकेचे वस्तू व सेवाकर सल्लागार एकबोटे देशमुख अँड कंपनी यांच्या दि. १८.०४.२०२३ रोजी प्राप्त झालेल्या अभिप्रायानुसार सदर छाननी शुल्कावर (Scrutiny Fee) १८% दराने वस्तू व सेवाकर लागू आहे. त्यानुसार आकारावयाच्या छाननी शुल्काचे सुधारित दर खालीलप्रमाणे आहेत :-

अनु क्र.	स्वारस्याची अभिव्यक्ती प्रस्ताव/ मालाचा पुरवठा/ सल्लागार सेवासह स्थापत्य कामे आणि सेवा इत्यादी विषयक कार्यालयीन अंदाजे रक्कम	अनस्टार दरपत्रिका/निविदा/दरपत्रिका/ ई-दरपत्रिका/ ई-निविदा दस्तऐवजांचे विद्यमान छाननी शुल्क (दि. ११.०५.२०२३ पासून दि. ३१.०३.२०२४ पर्यंत)	दि. ०१.०४.२०२४ पासून दि. ३१.०३.२०२५ पर्यंत मागविण्यात येणाऱ्या अनस्टार दरपत्रिका/निविदा/दरपत्रिका/ ई-दरपत्रिका/ ई-निविदा दस्तऐवजांचे सर्व देकारदारांकडून वसूल करावयाचे छाननी शुल्क
०१	रु. ०३ लाखापर्यंत	रु. ३००/- + १८% वस्तू व सेवाकर	रु. ३३०/- + १८% वस्तू व सेवाकर
०२	रु. ३,००,००१/- ते रु. ५,००,०००/-	रु. ६००/- + १८% वस्तू व सेवाकर	रु. ६६०/- + १८% वस्तू व सेवाकर
०३	रु. ५,००,००१/- ते रु. १०,००,०००/-	रु. १,२००/- + १८% वस्तू व सेवाकर	रु. १,३२०/- + १८% वस्तू व सेवाकर
०४	रु. १०,००,००१/- ते रु. २५,००,०००/-	रु.३,०००/- + १८% वस्तू व सेवाकर	रु.३,३००/- + १८% वस्तू व सेवाकर
०५	रु. २५,००,००१/- ते रु. ५०,००,०००/-	रु. ६,०००/- + १८% वस्तू व सेवाकर	रु. ६,६००/- + १८% वस्तू व सेवाकर
०६	रु. ५०,००,००१/- ते रु. १,००,००,०००/-	रु.१२,०००/- + १८% वस्तू व सेवाकर	रु.१३,२००/- + १८% वस्तू व सेवाकर
०७	रु. १,००,००,००१/- ते रु. २५,००,००,०००/-	रु.१५,०००/- + १८% वस्तू व सेवाकर	रु.१६,५००/- + १८% वस्तू व सेवाकर

०८	रु. २५,००,००,००१/- पेक्षा जास्त	रु.२५,०००/- + १८% वस्तू व सेवाकर	रु.२७,५००/- + १८% वस्तू व सेवाकर

अनस्टार दरपत्रिका/ निविदा/ दरपत्रिका/ ई-दरपत्रिका/ई-निविदा दस्तऐवजांकरिता छाननी शुल्काचे सुधारीत दर दि. ०१.०४.२०२४ ते दि. ३१.०३.२०२५ पर्यंत लागू राहतील.

तरी सर्व खाते प्रमुख/सहाय्यक आयुक्त / रुग्णालय प्रमुख / अधिष्ठाता यांनी त्यांच्या अखत्यारीतील संबंधित कर्मचारी वृदाना उपरोक्त सुचनेची काटेकोरपणे अंमलबजावणी करण्याचे तसेच दिनांक ०१.०४.२०२४ पासून मागविण्यात येणाऱ्या अनस्टार दरपत्रिका / निविदा / दरपत्रिका / ई-दरपत्रिका / ई-निविदा दस्तऐवजांकरिता या परिपत्रकातील सुधारीत किमतीनुसार दर आकारण्याचे निदेश द्यावेत.

सही/- २१.०२.२०२४  
श्री. प्रदीप भा. पडवळ  
प्रमुख लेखापाल (वित्त) प्र.

परिपत्रक

२०२३-२४

क्र.सीए/एफआरजी/१८ दिनांक २७.०२.२०२४

प्रत .....(जादा .....प्रतीसह ) यांना माहितीकरिता व पुढील आवश्यक त्या कार्यवाहीकरिता अग्रेषित.

*DBagwe*  
०१/३/२०२४  
प्रमुख लेखापाल (वित्त) यांजकरिता

बृहन्मुंबई महानगरपालिका

परिपत्रक

२०२३-२०२४

क्र. सीए/एफआरजी/ १० दिनांक १९.१०.२०२३

विषय :- महानगरपालिकेच्या विविध खात्यांमार्फत मागविण्यात येणा-या अनस्टार दरपत्रिका/  
निविदा/दरपत्रिका/ ई-दरपत्रिका/ ई-निविदा दस्तऐवजांच्या छाननी शुल्काबाबत

संदर्भ :- १) प्रले/एफसीई/२८ दि. १३.०१.२०२३

२) परिपत्रक क्र. सीए/एफआरजी/२१ दिनांक ०८.०२.२०२३

३) एमजीसी/एफ/९५८५ दि. ११.०५.२०२३

४) परिपत्रक क्र. सीए/एफआरजी/०३ दिनांक ११.०५.२०२३

५) अति.आ./प्रकल्प/१३५१ दि. २३.०५.२०२३

६) परिपत्रक क्र. सीए/एफआरजी/०४ दि. २४.०५.२०२३

बृहन्मुंबई महानगरपालिकेच्या विविध खात्यांमार्फत मागविण्यात येणाऱ्या अनस्टार दरपत्रिका/निविदा/दरपत्रिका/ ई-दरपत्रिका/ई-निविदा दस्तऐवजांकरिता छाननी शुल्क आकारण्याबाबत उपरोक्त संदर्भ क्र. ४ व ६ अन्वये परिपत्रक निर्गमित करण्यात आले होते. परिपत्रक क्र. सीए/एफआरजी/०३ दिनांक ११.०५.२०२३ मध्ये पुढील प्रमाणे निर्देश देण्यात आले आहेत.

“सर्व खाते प्रमुख/सहाय्यक आयुक्त/रुग्णालय प्रमुख, अधिष्ठाता यांनी त्यांच्या अखत्यारीतील संबंधित कर्मचारीवृंदांना उपरोक्त सुचनेची काटेकोरपणे अंमलबजावणी करण्याचे तसेच मंजुरीच्या दिनांकापासून मागविण्यात येणाऱ्या अनस्टार दरपत्रिका/ निविदा/ दरपत्रिका/ ई-दरपत्रिका/ई-निविदा दस्तऐवजांकरिता निविदा शुल्क न आकारता सर्व देकारदारांकडून या परिपत्रकातील सुधारीत दरांनुसार इसारा अनामत रक्कमेचा परतावा करण्यापूर्वी छाननी शुल्क अनुज्ञेय वस्तू व सेवाकरासहित वसूल करण्याचे अथवा देकारदाराच्या संमतीने इसारा अनामत रक्कमेतून समायोजित करण्यासंबंधीचे निर्देश द्यावेत. ”

तदनंतर सुधारित परिपत्रक क्र. सीए/एफआरजी/०४ दि. २४.०५.२०२३ निर्गमित करण्यात आले. सदर परिपत्रकात पुढील प्रमाणे निर्देश देण्यात आले आहेत.

“दरपत्रिका/निविदा/दरपत्रिका/ई-दरपत्रिका/ई-निविदा दस्तऐवजांकरिता मा. महानगरपालिका आयुक्तांच्या मंजुरीच्या दिनांकापासून छाननी शुल्क न आकारता, एसआरएम कार्यप्रणाली मध्ये निविदा शुल्क न आकारण्यासंबंधीची कार्यवाही माहिती व तंत्रज्ञान खात्याकडून पूर्ण झाल्यावर त्यानंतरच निविदाकाराकडून छाननी शुल्क आकारण्यात यावेत. तसेच सदर छाननी शुल्काचा भरणा लेखा संकेताक 140402609 - Scrutiny Fees From Tenders (From May 2023)-Taxable यामध्ये करण्यात यावा.”



परिपत्रक क्र. सीए/एफआरजी/०४ दि. २४.०५.२०२३ मध्ये नमूद केल्यानुसार एसआरएम प्रणाली मध्ये आवश्यक ते बदल माहित व तंत्रज्ञान विभागाकडून दि. २३.०६.२०२३ रोजी पूर्ण करण्यात आले आहेत.

दरम्यान माहिती व तंत्रज्ञान विभागामार्फत परिपत्रक क्र. Dir/IT/F-59 दि. १०.०५.२०२३ निर्गमित करण्यात आले. सदर परिपत्रकामध्ये दि. १५.०६.२०२३ पासून रु.२५ लाखावरील सर्व निविदा महानगरपालिकेच्या एसआरएम प्रणालीद्वारे न मागविता महाराष्ट्र शासनाच्या महाटेंडर पोर्टलद्वारे मागाविण्याबाबत निर्देश देण्यात आले आहेत. तसेच परिपत्रक क्र. सीए/एफआरजी/०३ दिनांक ११.०५.२०२३ मध्ये इसारा अनामत रक्कमेचा परतावा करण्यापूर्वी छाननी शुल्क, अनुज्ञेय वस्तू व सेवाकरासहित वसूल करण्याचे अथवा देकारदाराच्या संमतीने इसारा अनामत रक्कमेतून समायोजित करण्यासंबंधीचे निदेश देण्यात आले आहेत. तथापि महाराष्ट्र शासनाच्या महाटेंडर पोर्टलवर इसारा अनामत रक्कमेतून समायोजना करण्याची सुविधा नसल्याने पुढील प्रमाणे सुधारित निर्देश देण्यात येत आहेत.

“महाराष्ट्र शासनाच्या महाटेंडर / एसआरएम प्रणालीद्वारे मागविण्यात येणारे सर्व अनस्टार दरपत्रिका/निविदा/दरपत्रिका/ ई-दरपत्रिका/ ई-निविदा दस्तऐवजांकरिता निविदा शुल्क (Tender Fee) न आकारता सर्व देकारदारांकडून परिपत्रक क्र. सीए/एफआरजी/०३ दिनांक ११.०५.२०२३ मधील सुधारित दरांनुसार छाननी शुल्क (Scrutiny Fee) अनुज्ञेय वस्तू व सेवाकरासहित लिफाफा 'अ' व 'ब' उघडल्यानंतर व लिफाफा 'क' उघडण्याआधी फक्त नागरी सुविधा केंद्रात चलनाद्वारे भरण्यात यावे.”

संदर्भित परिपत्रकातील अन्य निर्देशांमध्ये कोणताही बदल करण्यात आलेला नाही.

सही/-१६.१०.२०२३  
श्री.पांडुरंग गोसावी  
प्रमुख लेखापाल (पा.पु.म.नि.)

सही/-१६.१०.२०२३  
श्री. प्रदिप भा. पडवळ  
प्रमुख लेखापाल (वित्त)प्र.

सही/-१६.१०.२०२३  
श्री. प्रशांत गायकवाड  
उप. आयुक्त (वित्त) प्र.

सही/-१८.१०.२०२३  
श्री. पी. वेलरासू  
अति.आयुक्त (प्रकल्प)

परिपत्रक

२०२३-२४

क्र.सीए/एफआरजी/१० दिनांक १९.१०.२०२३

प्रत .....(जादा .....प्रतीसह ) यांना माहितीकरिता व पुढील  
आवश्यक त्या कार्यवाहीकरिता अग्रेषित.

*B. Bagwe*  
19/10/23  
प्रमुख लेखापाल (वित्त) यांजकरिता

**BRIHANMUMBAI MUNICIPAL CORPORATION****Circular**

No. CA/Finance/Project/19 , Date 04.03.2024

Subject - Revised guidelines for payment of EMD for tenders to be uploaded on Mahatender Portal.

- Ref -
1. MDD/7878, dt.27.09.2016.
  2. Dir./IT/F-59, dt.10.05.2023.
  3. Dir./IT/505038 , dt.19.12.2023

As per the guideline issued vide circular mention in reference no. 2 & 3, all department are directed to use Mahatender for all the tenders above 25 lacs with effect from 15<sup>th</sup> June 2023, and for tenders below 25 lacs with effect from 21<sup>st</sup> December 2023 respectively. Accordingly all departments of BMC shall use e-Procurement System of Government of Maharashtra (Mahatender). Further, it has been directed that, all BMC department will have to follow the standard procedures of the said e-Tendering system of GoM and make relevant changes in their respective tender documents.

For participating in bidding process, bidders are required to deposit Earnest Money Deposit (EMD) through the payment gateways while submitting the bids. In BMC's tenders, in some cases, as per the relevant clause of tender, 10% of EMD amount has to be forfeited. Further, in some cases, for more than 2 curable-defects shortfalls, 2% of EMD per instance is forfeited. However, in Mahatender System, there is no such provision of partial forfeiture of EMD amount. Hence, the existing condition of partial forfeiture of EMD elaborated above needs to be modified. Further, the work of modifying Standard Bid Document of BMC under chairmanship of DMC (Infra) is under progress. Final decision regarding partial forfeiture of EMD will be taken by the committee. However, till then, to streamline the process of bidding, interim instructions regarding EMD are as follows;

C:\Users\3938308\Desktop\100% Online EMD 21.02.2023.docx

**1) Mode of payment of EMD**

A tenderer shall pay entire amount of EMD through payment gateways of GoM on URL <http://mahatenders.gov.in>. The bidder shall upload scan copy of online paid EMD along with the bid submission in packet 'A'.

Any bid not accompanied by an acceptable Bid Security shall be rejected by the Employer as non-responsive.

**2) If non-responsive;**

If the bidder is found non-responsive after scrutiny of packet 'A'/'B', in such circumstances, **the bidder will be made non-responsive and financial packet 'C' of non-responsive bidder will not be opened. However, there will not be any forfeiture of EMD.**

**3) Shortfalls:-**

Maximum 5 shortfalls of curable defects shall be allowed and in case, curable defects are not compiled by bidder within given time period, the bidder shall be treated as '**Non-Responsive**' & such cases will be informed to Registration and Monitoring Cell. Such non-submission of documents will be considered as 'Intentional Avoidance' and if three or more cases in 12 months are reported, shall be viewed seriously and disciplinary action against the defaulters such as banning/de-registration, etc. shall be taken by Registration Cell with due approval of the concerned AMC.

**4) Refund of EMD :-**

- c) Except successful bidder all other unsuccessful bidders' 100% EMD paid online will be refunded automatically.
- d) The Bid security of successful bidder will be discharged when the bidder has signed the agreement and /or furnish the required Security Deposits as elaborated in Standard Bid Document.

**5) Forfeiture of Entire EMD:-**

The existing conditions laid down in Standard Bid Document regarding forfeiture of entire bid security (EMD) shall remain unchanged.

These, interim-instructions will remain in force till the issuance of circular regarding amendment in SBD.

All the concerned Assistant Commissioners / HoDs shall note the above directives and to incorporate suitable clause in the draft tenders to be invited hereafter with immediate effect.



(Pandurang V. Gosavi)  
**Chief Accountant (W.S.S.D.)**

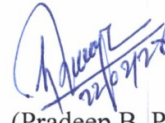

(Pradeep B. Padwal)  
**Chief Accountant (Finance) i/c**



(Shri. P. N. Gaikwad)  
**D.M.C. (Finance)**  
Sir,

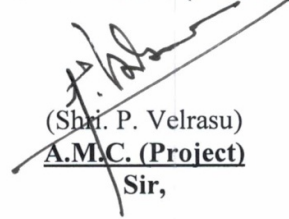

(Shri. P. Velrasu)  
**A.M.C. (Project)**  
Sir,



## बृहन्मुंबई महानगरपालिका

परिपत्रक

२०१९-२०

क्रमांक : सीए/एफबीके/२४९, दिनांक २७.११.२०१९

विषय : बँकेने दिलेले हमीपत्र (बँकर्स गॅरंटी) स्विकारण्याबाबत.

संदर्भ : सीए/एफबीके/३९, दिनांक - ०७/१२/२०१२

सीए/एफबीके/२५, दिनांक - १०/१०/२०१२

कंत्राटदार / पुरवठादार यांच्याकडून सादर करण्यात येणारी बँक हमीपत्रे (बँकर्स गॅरंटी) स्विकारण्यासंदर्भात उपरोक्त संदर्भाधीन परिपत्रकान्वये मार्गदर्शनपर सूचना परिक्रमित करण्यात आल्या आहेत. सादर परिपत्रकातील परिच्छेद क्रमांक २ मध्ये पुढील प्रमाणे सुधारणा करण्यात येत आहेत.

सादर परिपत्रकात नमूद केलेली भारतीय रिझर्व बँकेची "rbidocs.rbi.org.in/rdocs/publications/pdfs/84656.pdf" ही लिंक "www.rbi.org.in" अशी वाचण्यात यावी.

तरी, सर्व खातेप्रमुख, सहाय्यक महापालिका आयुक्त आणि संबंधित यांनी वरील सुधारणेची नोंद घेऊन संबंधित कंत्राटदार/पुरवठादार यांना अवगत करावे.

सही/- १४.११.२०१९  
प्रमुख लेखापाल (पा.पु.म.नि.)

सही/- १४.११.२०१९  
प्रमुख लेखापाल (वित्त) प्र.

परिपत्रक

२०१९-२०

क्रमांक : सीए/एफबीके/२४९, दिनांक २७.११.२०१९

यांना प्रत (-----) अधिक प्रतींसह  
माहितीकरिता व योग्य त्या कार्यवाहीसाठी पाठवित आहे.

सादर परिपत्रक महानगरपालिकेच्या <ftp://hr.mcgm.gov.in/Circular/CA/Finance/2019/> या संकेतस्थळावर प्रसिद्ध करण्यात आलेले आहे.

बृहन्मुंबई महानगरपालिका  
प्रमुख लेखापाल पापुमनि खाते  
लेखा अधिकारी ५१ एन

30 DEC 2019  
2986-182

NS3429-CA-3MPP-39772-2019-20-2200(copies)

प्र.ले./पापुमनि/५१एन

G:\SANDIP LETTERS\2.doc77

प्र.प्र. ३१/१२/१९

प्र.प्र. ३१/१२/१९

प्र.प्र. कथरे ३१/१२/१९  
प्रमुख लेखापाल (वित्त) यांजकरिता

३१.०१.१९  
०१-०१-२०२०

## THE SECOND SCHEDULE TO THE RESERVE BANK OF INDIA ACT, 1934

*[Sections 2(e) and 42]*

## SCHEDULED BANKS

STATE CO-OPERATIVE BANKS
Andhra Pradesh State Co-operative Bank Ltd. Hyderabad
Bihar State Co-operative Bank Ltd., Bihar
Goa State Co-operative Bank Ltd. , Panaji
Gujarat State Co-operative Bank Ltd., Ahmedabad
Haryana State Co-operative Apex Bank Ltd., Chandigarh
Karnataka State Co-operative Apex Bank Ltd., Bangalore
Kerala State Co-operative Bank Ltd., Thiruvananthapuram
Madhya Pradesh Rajya Sahakari Bank Maryadit, Bhopal
Maharashtra State Co-operative Bank Ltd., Mumbai
Orissa State Co-operative Bank Ltd., Bhubaneswar
Pondicherry State Co-operative Bank Ltd. Pondicherry
Punjab State Co-operative Bank Ltd., Chandigarh
Rajasthan State Co-operative Bank Ltd., Jaipur
Tamil Nadu State Apex Co-operative Bank Ltd., Chennai
Uttar Pradesh Co-operative Bank Ltd., Lucknow
West Bengal State Co-operative Bank Ltd., Kolkata

Urban Co-operative Banks
A P Mahesh Co-operative Urban Bank Ltd., Hyderabad
Abhyudaya Co-operative Bank Ltd., Mumbai
Ahmedabad Mercantile Co-operative Bank Ltd., Ahmedabad
Akola Janata Commercial Co-operative Bank Ltd., Akola
Amanath Co-operative Bank Ltd., Bangalore
Bassein Catholic Co-operative Bank Limited, Vasai
Bharat Co-operative Bank (Mumbai) Ltd., Mumbai
Bharati Sahakari Bank Ltd., Pune
Bombay Mercantile Co-operative Bank Limited, Mumbai
Charminar Co-operative Urban Bank Ltd., Hyderabad
Citizen Credit Co-operative Bank Ltd., Mumbai
Dombivli Nagari Sahakari Bank Ltd., Dombivli
Greater Bombay Co-operative Bank Limited, Mumbai
Indian Mercantile Co-operative Bank Ltd., Lucknow
Jalgaon Janata Sahakari Bank Ltd., Jalgaon
Janakalyan Sahakari Bank Ltd., Mumbai
Janalaxmi Cooperative Bank Ltd., Nashik
Janata Sahakari Bank Ltd., Pune
Kallappa Anna Awade Ichalkaranji Janata Sahakari Bank Ltd., Ichalkaranji
Kalapur Commercial Co-operative Bank Ltd., Ahmedabad.
Kalyan Janata Sahakari Bank Ltd., Kalyan
Kapol Cooperative Bank Ltd., Mumbai
Karad Urban Co-operative Bank Ltd., Karad
Madhavapura Mercantile Co-operative Bank Ltd., Ahmedabad
Mahanagar Co-operative Bank Ltd., Mumbai
Mapusa Urban Co-operative Bank of Goa Ltd., Mapusa
Mehsana Urban Co-operative Bank Ltd., Mehsana
N K G S B Co-operative Bank Ltd., Mumbai
Nagar Urban Co-operative Bank Ltd., Ahmednagar
Nagpur Nagrik Sahakari Bank Ltd., Nagpur
New India Co-operative Bank Ltd., Mumbai
Nutan Nagrik Sahakari Bank Ltd., Ahmedabad
Parsik Janata Sahakari Bank Ltd., Thane
Pravara Sahakari Bank Ltd., Loni
Punjab & Maharashtra Co-operative Bank Ltd., Mumbai
Rajkot Nagrik Sahakari Bank Ltd., Rajkot
Rupee Co-operative Bank Ltd., Pune
Sangli Urban Co-operative Bank Ltd., Sangli
Saraswat Co-operative Bank Ltd., Mumbai
Sardar Bhiladwala Pardi People's Co-operative Bank Ltd., Killa Pardi
Shikshak Sahakari Bank Ltd., Nagpur
Solapur Janata Sahakari Bank Ltd., Solapur
Surat People's Co-operative Bank Ltd., Surat
Thane Bharat Sahakari Bank Ltd., Thane
Thane Janata Sahakari Bank Ltd., Thane
The Akola Urban Co-operative Bank Ltd., Akola
The Cosmos Co-operative Bank Ltd., Pune
The Goa Urban Co-operative Bank Ltd., Panaji
The Khamgaon Urban Co-operative Bank Ltd., Khamgaon
The Nasik Merchant's Co-operative Bank Ltd., Nasik
The Shamrao Vithal Co-operative Bank Ltd., Mumbai
The Zoroastrian Co-operative Bank Ltd., Mumbai
Vasavi Co-operative Urban Bank Limited, Hyderabad

SBI AND ASSOCIATES	
State Bank of India	
State Bank of Bikaner & Jaipur	
State Bank of Hyderabad	
State Bank of Indore	
State Bank of Mysore	
State Bank of Patiala	
State Bank of Saurashtra	
State Bank of Travancore	
NATIONALISED BANKS	
Allahabad Bank	
Andhra Bank	
Bank of Baroda	
Bank of India	
Bank of Maharashtra	
Canara Bank	
Central Bank of India	
Corporation Bank	
Dena Bank	
Indian Bank	
Indian Overseas Bank	
Oriental Bank of Commerce	
Punjab National Bank	
Punjab and Sind Bank	
Syndicate Bank	
UCO Bank	
Union Bank of India	
United Bank of India	
Vijaya Bank	
OTHER PUBLIC SECTOR BANKS	
Industrial Development Bank of India Ltd.	
PRIVATE SECTOR BANKS	
Bank of Rajasthan Ltd.	
Catholic Syrian Bank Ltd.	
City Union Bank Ltd.	
Development Credit Bank Ltd.	
Dhanalakshmi Bank Ltd.	
Federal Bank Ltd.	
HDFC Bank Ltd.	
ICICI Bank Ltd.	
IndusInd Bank Ltd.	
ING Vysya Bank Ltd.	
Jammu and Kashmir Bank Ltd.	
Karnataka Bank Ltd.	
Karur Vysya Bank Ltd.	
Kotak Mahindra Bank Ltd.	
Lakshmi Vilas Bank Ltd.	
Nainital Bank Ltd.	
Ratnakar Bank Ltd.	
SBI Commercial International Bank Ltd.	
South Indian Bank Ltd.	
Tamilnad Mercantile Bank Ltd.	
Axis Bank Ltd.	
Yes Bank Ltd.	



## FOREIGN BANKS

ABN Amro Bank N.V.
Abu Dhabi Commercial Bank Ltd.
American Express Banking Corporation
Antwerp Diamond Bank N.V.
Arab Bangladesh Bank
Bank International Indonesia
Bank of America
Bank of Bahrain and Kuwait B.S.C.
Bank of Ceylon
Bank of Nova Scotia
Bank of Tokyo – Mitsubishi Ltd.
Barclays Bank Plc.
BNP Paribas
China Trust Commercial Bank
Shinhan Bank
Citi Bank N.A.
Calyon Bank
Deutsche Bank
DBS Bank Ltd.
The Hongkong and Shanghai Banking Corporation Ltd.
J.P. Morgan Chase Bank N.A.
Krung Thai Bank Public Company Ltd.
Mashreq Bank p.s.c.
Mizuho Corporate Bank Ltd.
Oman International Bank S.A.O.G.
Societe Generale
Sonali Bank
Standard Chartered Bank
State Bank of Mauritius Ltd.

GRAMIN BANKS
Andhra Pradesh Grameen Vikas Bank, Warangal (Andhra Pradesh)
Andhra Pragathi Grameena Bank, Kadapa (Andhra Pradesh)
Aryavart Gramin Bank, Lucknow (Uttar Pradesh)
Arunachal Pradesh Rural Bank, Naharlagun (Arunachal Pradesh)
Assam Gramin Vikas Bank, Guwahati (Assam)
Baitarani Gramya Bank, Baripada (Orissa)
Ballia Kshetriya Gramin Bank, Ballia (Uttar Pradesh)
Bangiya Gramin Vikash Bank, Berhampore (West Bengal)
Baroda Gujarat Gramin Bank, Bharuch (Gujarat)
Baroda Rajasthan Gramin Bank, Ajmer (Rajasthan)
Baroda Uttar Pradesh Gramin Bank, Rae Bareli (Uttar Pradesh)
Bihar Kshetriya Gramin Bank, Monghyr (Bihar)
Cauvery Kalpatharu Grameena Bank, Mysore (Karnataka)
Chaitanya Godavari Grameena Bank (Andhra Pradesh)
Chhattisgarh Gramin Bank, Raipur (Chhattisgarh)
Chikmagalur-Kodaga Grameena Bank, Chikmagalur (Karnataka)
Deccan Grameena Bank, Dilsukhnagar (Hyderabad)
Dena Gujarat Gramin Bank, Gandhinagar (Gujarat)
Durg-Rajnandgaon Gramin Bank, Rajnandgaon (Chhattisgarh)
Ellaquai Dehati Bank, Srinagar (Jammu and Kashmir)
Etawah Kshetriya Gramin Bank, Etawah (Uttar Pradesh)
Faridkot Bhatinda Kshetriya Gramin Bank, Bhatinda (Punjab)
Gurgaon Gramin Bank, Gurgaon (Haryana)
Hadoti Kshetriya Gramin Bank, Kota (Rajasthan)
Haryana Gramin Bank, Rohtak (Haryana)
Himachal Gramin Bank, Mandi (Himachal Pradesh)
Jaipur Thar Gramin Bank, Jaipur (Rajasthan)
Jammu Rural Bank, Jammu
Jhabua-Dhar Kshetriya Gramin Bank, Jhabua (Madhya Pradesh)
Jharkhand Gramin Bank, Ranchi (Jharkhand)
Kalinga Gramya Bank, Cuttack (Orissa)
Kamraz Rural Bank, Sopore (Jammu and Kashmir)
Karnatka Vikas Gramin Bank, Dharwad (Karnataka)
Kashi Gonti Samyut Gramin Bank, Varanasi (Uttar Pradesh)
Khasi J Bank, Shillong (Meghalaya)
Krishna Grameena Bank, Gulbarga (Karnataka)
Kshetriya Kisan Gramin Bank, Mainpuri (Uttar Pradesh)
Langpi Dehangi Rural Bank, Dhiphu (Assam)
Lucknow Kshetriya Gramin Bank, Sitapur (Uttar Pradesh)
Madhya Bharath Gramin Bank, Sagar (Madhya Pradesh)
Madhya Bihar Gramin Bank, Patna (Bihar)
Mahakaushal Kshetriya Gramin Bank, Jabalpur (Madhya Pradesh)
Maharashtra Godavari Gramin Bank (Maharashtra)
Malwa Gramin Bank, Sangrur (Punjab)
Marwar Ganganagar Bikaner Gramin Bank, Pali (Rajasthan)
Manipur Rural Bank, Imphal (Manipur)
Marathwada Gramin Bank, Nanded (Maharashtra)
Mewar Aanchalik Gramin Bank, Udaipur (Rajasthan)
Mizoram Rural Bank, Aizawl (Mizoram)
Nagaland Rural Bank, Kohima (Nagaland)
Nainital Almora Kshetriya Gramin Bank, Nainital (Uttaranchal)
Narmada Malwa Gramin Bank, Indore (Madhya Pradesh)
Neelachal Gramya Bank (Orissa)
North Malabar Gramin Bank, Kannur (Kerala)
Pallavan Grama Bank, Salem (Tamil Nadu)

Pandyan Grama Bank, Virudhunagar (Tamil Nadu)
Paschim Banga Gramin Bank, Howrah (West Bengal)
Parvatiya Gramin Bank, Chamba (Himachal Pradesh)
Pragathi Gramin Bank, Bellary (Karnataka)
Prathama Bank, Moradabad (Uttar Pradesh)
Puduvai Bharthiar Grama Bank (Pondicherry)
Punjab Gramin Bank, Kapurthala (Punjab)
Purvanchal Gramin Bank, Gorakhpur (Uttar Pradesh)
Rajasthan Gramin Bank, Alwar (Rajasthan)
Ratnagiri Sindhudurg Gramin Bank, Ratnagiri (Maharashtra)
Rewa-Sidhi Gramin Bank, Rewa (Madhya Pradesh)
Rushikulya Gramya Bank, Berhampur (Orissa)
Samastipur Kshetriya Gramin Bank, Samastipur (Bihar)
Saptagiri Grameena Bank, Chittoor (Andhra Pradesh)
Sarva UP Gramin Bank (Uttar Pradesh)
Satpura Narmada Kshetriya Gramin Bank, Chhindwara (Madhya Pradesh)
Saurashtra Gramin Bank, Rajkot (Gujarat)
Sharda Gramin Bank, Satna (M.P.)
Shreyas Gramin Bank, Aligarh (Uttar Pradesh)
Solapur Gramin Bank, Solapur (Maharashtra)
South Malabar Gramin Bank (Kerala)
Surguja Kshetriya Gramin Bank, Ambikapur (Chhattisgarh)
Tripura Gramin Bank, Agartala (Tripura)
Triveni Kshetriya Gramin Bank, Orai (Uttar Pradesh)
Utkal Gramya Bank, Bolangir (Orissa)
Uttaranchal Gramin Bank, Dehradun (Uttaranchal)
Uttar Banga Kshetriya Gramin Bank, Cooch-Behar (West Bengal)
Uttar Bihar Kshetriya Gramin Bank, Muzaffarpur (Bihar)
Vananchal Gramin Bank, Dhumka (Jharkhand)
Vidharbha Kshetriya Gramin Bank, Akola (Maharashtra)
Vidisha-Bhopal Kshetriya Gramin Bank, Vidisha (Madhya Pradesh)
Visveshwaraya Gramoon Bank, Mandya (Karnataka)
Wainganga Kshetriya Gramin Bank, Chandrapur (Maharashtra)